

Your Global Automation Partner

TURCK

Overview Capacitive Sensors



Capacitive Sensors

When working with liquids or bulk material, capacitive sensors help to detect levels and provide an overview of the production process at any time. For consumption monitoring and requirements planning, obtaining information on limit levels is essential in order to enable early planning and ensure smooth processes.

Whether in the plastics, packaging or chemical industry, or in mobile equipment, capacitive sensors reliably detect all solid materials, liquids, metals and non-metals. Detection is also possible through non-metallic materials as well as container walls.

- Fast and easy installation
- No effect on the medium
- Wear-free



Technology in the smallest space
Thanks to the implementation of high quality components in a compact 5.5 mm wide and stable housing, the sensors offer installation and detection options that were previously inconceivable.



Outstanding EMC immunity
Thanks to special protective measures, the sensors ensure high EMC immunity even in environments with increased electromagnetic interference (industrial areas).

BCT – Capacitive sensors with IO-Link

The BCT series with IO-Link reduces the time and expenditure required for setting switch points and extends the usefulness of the measuring signals through the digitized 12-bit process value.

Efficient commissioning

The switch states of the BCT sensors can either be taught via integrated buttons, a teach adapter or the IO-Link interface. Parameter setting via IO-Link is particularly efficient, since the setting is carried out with self-explanatory standard commands. The optimum operating point of the sensor can thus be calculated automatically and output as a 12-bit process value. The pa-

rameter setting is carried out more quickly, is more precise and incorrect settings are prevented. If specific adaptations are required, all the settings can be adjusted via the IO-Link interface.

Switch signal with added value

The digitized process value means that the detection of the medium can be represented as a quantity so that the smallest parameter deviations can be detected precisely. Changes in measuring conditions or different media can be determined reliably.

- Empty or full teach functionality
- Changing media
- Quality of the medium



BC – Capacitive sensors for standard applications

BC series sensors are indispensable in standard applications. They are provided with moisture and condensation compensation. Whether installed flat on a pipe or tube, through a plastic or glass wall, the medium is always detected.

- With Ex approval
- In chemical resistant housings
- Ideal for: Water, ink (solvent-based), fertilizers, road salt, fine gravel, metal, wood, paper

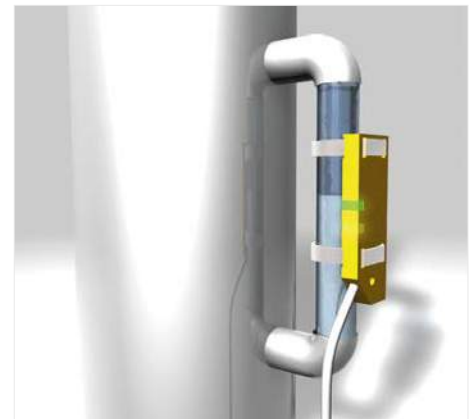

Maximum flexibility

IO-Link enables parameters to be set centrally without requiring the sensor to be accessible. The digital data transmission is based on a 24 V signal. Shielded cables and grounding systems for the transmission of analog signals thus become unnecessary.



Reliable detection

The sensors of the BCT and BCF series are not affected by deposits and conductive films on container walls. They also feature a special filter for moisture compensation, which masks out deposits on the container wall and prevents a drifting of the switch point.

BCC – Capacitive sensors for bulk materials of statically charged media

BCC series sensors are optimized for the detection of dry bulk materials. The detection of powders or granulates, also through particularly large wall thicknesses, are not a problem for the sensors. Due to their special shielding, the sensors are also reliably protected from static discharges.

- No risk of failure due to ESD
- Increased protection from EMC interference
- Ideal for: Plastic granules, wood pellets, wood chip



BCF – Capacitive sensors for sticky media

Deposits and conductive films on a container wall represent a particular challenge. Sensors of the BCF series remove these obstacles. Besides the moisture compensation, the BCF sensors are fitted with a special filter which masks out sticking deposits on the container wall.

- Masking out of sticking deposits and conductive films
- Increased protection from EMC interference
- Increased system availability
- Ideal for: Oils, greases, lubricants, ink, acids, sauces and alkalis (water-based), cleaning agent, seeds



Improved process reliability















The 12-bit resolution of the process value makes it possible to provide detailed information on the detection process and implement differentiated system diagnostics, and thus reliably ensure process reliability. This is likewise ensured by the extra thick housing and the particularly high EMC immunity.

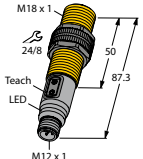
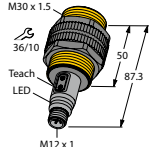
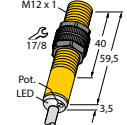
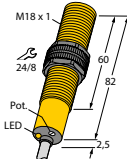
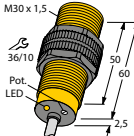
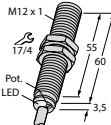
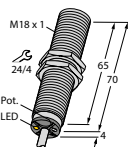
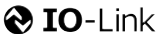

Increased system availability

The integrated monitoring of the internal temperature and voltage provide information on the thermal load of the sensor and are an indication of its failure probability. When critical values are reached, this enables the user to intervene immediately before any damage leads to plant downtimes.

Types and Features

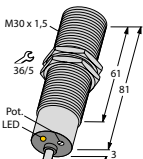
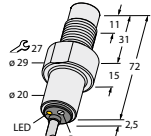
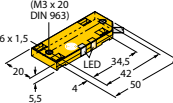
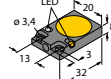
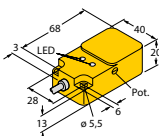
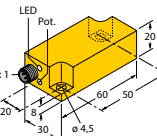
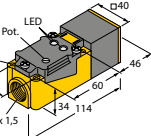
Design							
Dimension drawing							
Description	Setting via buttons or programming PIN	Setting via buttons or programming PIN	Setting via potentiometer or fixed setting	Setting via potentiometer or fixed setting	Setting via potentiometer or fixed setting	Setting via potentiometer or fixed setting	Setting via potentiometer or fixed setting
Model	BCT 	BCT 	BC	BCF, BCC	BCF, BCC	BC	BC, BCF
Design							
Dimension drawing							
Description	Setting via potentiometer or fixed setting	For direct contact with the medium, resistant to chemicals	Setting via potentiometer or fixed setting	Setting via potentiometer or fixed setting	Setting via potentiometer or fixed setting	Setting via potentiometer or fixed setting	Setting via potentiometer or fixed setting
Model	BC, BCF	BC	BC	BC	BC	BCF	BC, BCF

Medium	Container wall	BCT	BC	BCC	BCF	S12	S18	S30	QF5.5
Water	Plastic	✓	✓	-	-	•	✓	•	✓
	Glass	✓	✓	-	-	-	✓	•	✓
	Direct medium contact	✓	✓	-	-	✓	✓	✓	-
Oil	Plastic	✓	•	-	✓	-	•	✓	✓
	Glass	✓	•	-	✓	-	✓	✓	✓
	Direct medium contact	✓	•	-	✓	✓	✓	✓	-
Grease/lubricants	Plastic	✓	•	-	✓	-	✓	✓	✓
	Glass	✓	•	-	✓	-	✓	✓	✓
	Direct medium contact	✓	•	-	✓	✓	✓	✓	-
Water-based acids and alkalis	Plastic	✓	•	-	✓	•	✓	✓	✓
	Glass	✓	•	-	✓	•	✓	✓	✓
	Direct medium contact	✓	•	-	✓	•	✓	✓	-
Ink, water-based	Plastic	✓	•	-	✓	•	✓	✓	•
	Glass	✓	•	-	✓	•	✓	✓	•
	Direct medium contact	✓	•	-	✓	•	✓	✓	-
Ink, solvent-based	Plastic	✓	✓	-	-	-	✓	✓	•
	Glass	✓	✓	-	-	-	✓	✓	•
	Direct medium contact	✓	✓	-	-	•	✓	✓	-
Cleaning agents	Plastic	✓	•	-	✓	•	✓	✓	•
	Glass	✓	•	-	✓	-	✓	✓	•
	Direct medium contact	✓	•	-	✓	✓	✓	✓	-
Plastic granules	Plastic	✓	•	✓	-	-	-	✓	•
	Glass	✓	•	✓	-	-	-	✓	•
	Metal	•	•	✓	-	-	-	✓	-
	Direct medium contact	✓	•	✓	-	-	-	✓	-
Wood pellets, wood chip	Plastic	✓	•	✓	-	-	✓	✓	✓
	Glass	✓	•	✓	-	-	-	✓	✓
	Direct medium contact	✓	•	✓	-	•	•	✓	✓
Fertilizers	Plastic	✓	✓	-	-	•	✓	•	✓
	Direct medium contact	✓	✓	-	-	-	✓	•	-
Seeds	Plastic	✓	✓	-	✓	-	✓	•	✓
	Direct medium contact	✓	✓	-	✓	-	✓	•	-
Road salt	Plastic	✓	✓	-	-	-	✓	•	✓
	Direct medium contact	✓	✓	-	-	•	✓	•	-
Fine gravel	Plastic	✓	✓	-	-	-	✓	•	✓
	Direct medium contact	✓	✓	-	-	•	✓	•	-
Metal	None	✓	✓	-	-	•	✓	•	✓
	Plastic	✓	✓	-	-	•	✓	•	✓
	Carton	✓	✓	-	-	•	✓	•	-
Wood	None	✓	✓	-	-	•	✓	•	✓
	Plastic	✓	✓	-	-	-	•	✓	✓
	Carton	✓	✓	-	-	-	•	✓	-
Paper	None	✓	✓	-	-	•	•	✓	✓
	Plastic	✓	✓	-	-	-	•	✓	✓
	Carton	✓	✓	-	-	-	-	✓	-

✓ optimal • suitable - unsuitable

Over 30 subsidiaries and
60 representatives worldwide!

