

Your Global Automation Partner

TURCK

Connectivity Catalog



A Global Leader in Industrial Automation

Turck's sensors, connectivity, network and interface products are built to be the best. As one of the most **prominent** sensor manufacturers **in the world**, we even back our sensors with a **lifetime warranty**. Turck works by bringing **rugged engineering** solutions to your industrial automation applications.

85,000+
SOLUTIONS

50+
YEARS OF INNOVATION

2,000+
EXPERIENCED SALES REPRESENTATIVES

Pioneer in non-contact
sensing technology

Developed innovative **connectivity**
solutions in response to our sensor customer needs

Recognized need and advanced knowledge of harsh duty
environments lead to **I/O solutions**

**SUPPORT &
DEDICATED SERVICE**

EXTENSIVE WARRANTY

 **4,000+**
APPLICATION EXPERTS

RESPOND
and SOLVE over **1,200** inquiries
per day



Strategically placed manufacturing facilities in the

USA with **28** GLOBAL
SUBSIDIARIES

GLOBAL BUT LOCAL...

60 representations worldwide

TURCK

THE ADVANTAGE

ENGINEERED SOLUTIONS

At Turck, we understand that not every application is the same. That's why we dedicate ourselves to finding the optimal engineered solution for every application.

Whether you need a cordset, network I/O, or sensor, our range of innovative manufacturing

capabilities and engineering expertise allows us to achieve what others cannot.

Turck offers advanced designs and the most up to date manufacturing processes – including EDM, molding, and laser trimming – allowing our products to thrive in the harshest environments.

THAT'S THE TURCK ADVANTAGE.

more than

13,000

CUSTOM SKUs



INNOVATIVE MANUFACTURING CAPABILITIES

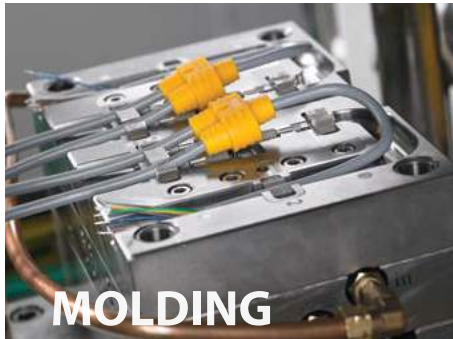

10 YEARS EXPERIENCE

providing customers with
engineered solutions

Just to name a few....

- overmolds
- RFID tags
- kitting
- wiring/pinouts
- pigtailed/mold-ons
- color coded wiring
- free software & support
- cable lengths
- daisy chains
- silicone tubing
- extreme environments
- harness assemblies
- mix & match I/O
- major industry protocols
- private labeling
- snap-in labels

and more...

Engineered solutions for all application challenges

TURCK

THE GOLD STANDARD

GREAT VALUE

COMPLIMENTARY AUDITS

- At Turck, we consider it our job to help our customers decrease failures and reduce operation downtime. That's why we offer a complimentary audit program. The audit helps you identify, evaluate, and solve problem areas where sensors and cordsets

are continually damaged or destroyed. This reduction in downtime will save you costs, ensuring you get the most out of your production processes.

WARRANTY

- We have confidence in our products, and believe you should too. All of our products come with extensive warranties to assure you that our products are not only built to

work, but built to last. We also have 3,500+ application experts ready to support you with any application issues that may arise.

Quality

MATERIALS

built to last in the harshest environments

- stainless steel
- nickel plated brass
- viton
- rubber
- gold
- PUR/TPU/TPE
- armored cable
- washdown
- extreme temperatures and more...

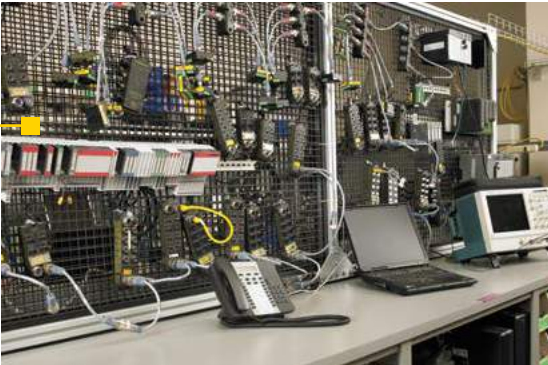

Ship 1 to 1 Million with NO MINIMUM

We understand that not everyone needs 1,000 or one million parts. We offer flexible minimum orders to ensure you get exactly the number of parts you need.

Our products undergo

EXTENSIVE TESTING

To continuously deliver solutions of only the highest quality, we put our products through a rigorous set of tests. These tests are in accordance with national and international standards such as IEC and UL to confirm that they meet and exceed industry standards, ensuring their survivability and dependability in all applications.



Point of Use

INVENTORY

Get immediate access to Turck products with your own on-site Turck vending machine. Convenient access can help you save money while reducing downtime by having your products easily accessible at a moment's notice.

M8 Picofast®	C
M12 Eurofast®	D
1/2-20 Microfast®	E
7/8", 1" and 1 1/8" Minifast®	F
M16 Versafast®	G
M23 and M27 Multifast®	H
Powerfast	J
Ethernet	K
PROFINET	L
DeviceNet™	M
FOUNDATION™ fieldbus	N
PROFIBUS® -DP/PA	P
AS-interface®	R
Junction Box (Multibox®)	S
Valve Plugs	T
Accessories	U
Splitters	V
Reference	W
Warranty	Y

Part Number Keys	C2
Cordsets	C4
Receptacles	C16
Field Wireables	C24
Inserts	C28
Closure Caps	C31

Features

- 3, 4 and 6 pins
- Threaded or snap mating
- Nickel-brass or stainless steel materials
- Straight and angled connectors
- LED options
- Receptacles with leads or PCB pins



Cordset Part Number Key

Part Number Keys are to assist in IDENTIFICATION ONLY. Consult factory for catalog items not identified.

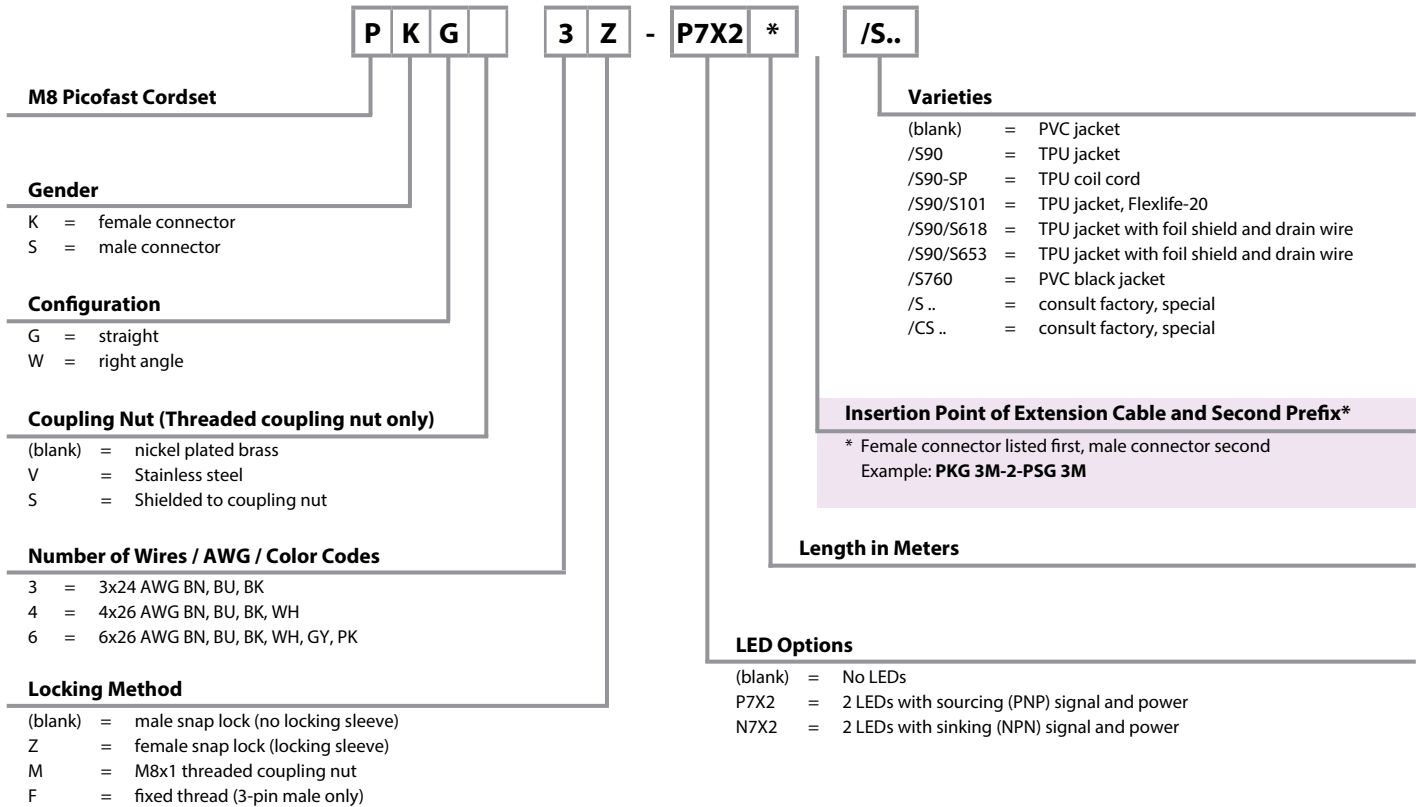

Extension Examples:

Hybrid connector extensions also available. Consult factory.

Extension Examples:

Hybrid connector extensions also available. Consult factory.

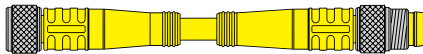

PKG 3M - 2 - PSG 3M

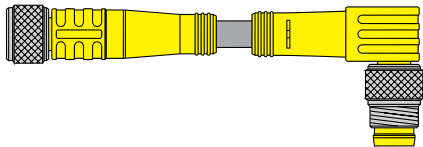

PKG 3M - 2 - PSW 3M

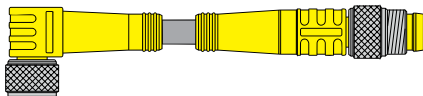

PKW 3M - 2 - PSG 3M

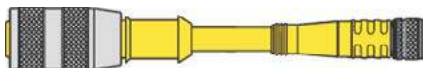

RK 4.4 T - 2 - PKG 4M

Receptacle Part Number Key

Part Number Keys are to assist in IDENTIFICATION ONLY. Consult factory for catalog items not identified.

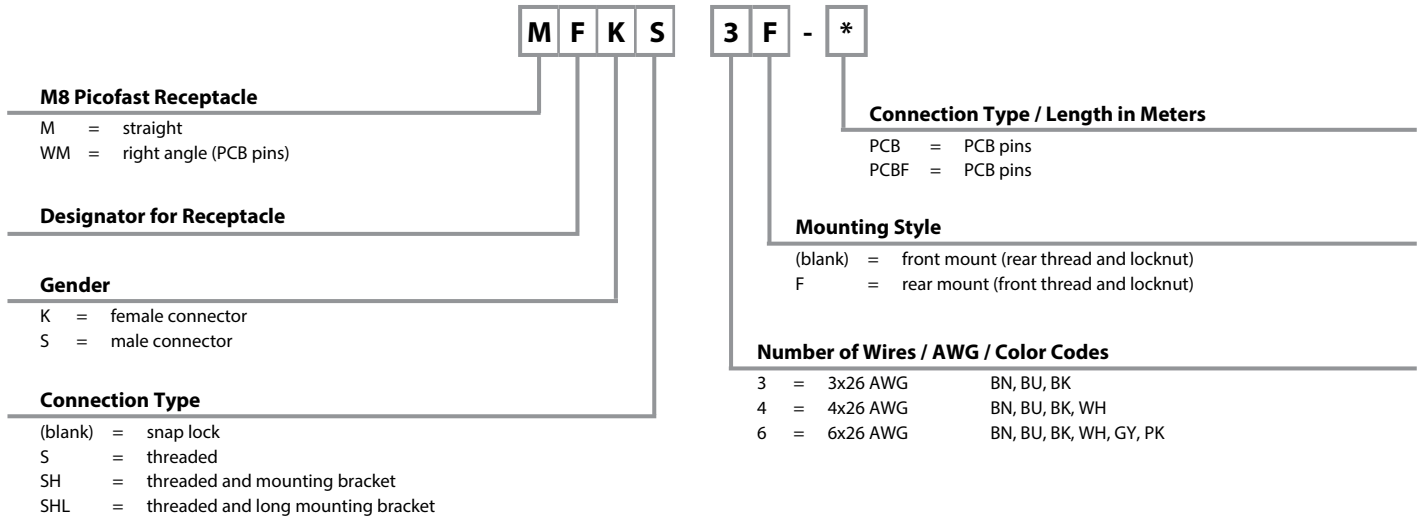

picofast®

Field Wireable Part Number Key

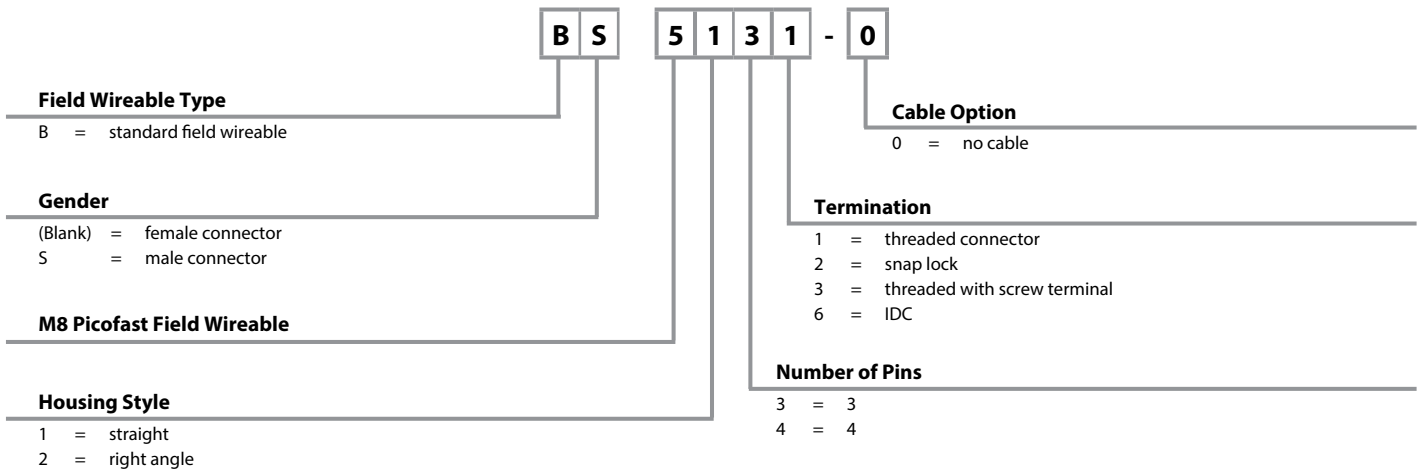

3-Wire Cordsets, Snap Lock (Locking Sleeve)

- NEMA 1, 3, 4, 6P
- IEC IP67 Protection
- 125 V, 4 A



Connector Style	Female Part Number	Male Part Number	Features	Pinout
<p>PKG ..Z**</p>	PKG 3Z-* PKW 3Z-*	PSG 3-* PSW 3-*	AWM, PVC Yellow, 3x24 AWG, 105 °C, 4.4 mm OD, Cable #RF50642-*M, Flexlife®	<p>Female</p> <p>Male</p>
<p>PKW ..Z**</p>	PKG 3Z-*/S90 PKW 3Z-*/S90	PSG 3-*/S90 PSW 3-*/S90	AWM, TPU Black, 3x24 AWG, 90 °C, 4.2 mm OD, Cable #RF50587-*M, Cut/Abrasion Immune	
<p>PSG ..</p>	PKG 3Z-*/S90/S101 PKW 3Z-*/S90/S101	PSG 3-*/S90/S101 PSW 3-*/S90/S101	AWM, TPU Black, 3x24 AWG, 90 °C, 4.4 mm OD, Cable #RF51166-*M, Cut/Abrasion Immune, Flexlife-20, High Flex - Over 20 Million Cycles	
<p>PSW ..</p>	PKG 3Z-*/S90/S618 PKW 3Z-*/S90/S618	PSG 3-*/S90/S618 PSW 3-*/S90/S618	AWM, TPU Black, 3x24 AWG, 90 °C, 4.2 mm OD, Cable #RF50601-*M, Cut/Abrasion Immune, EMI/RFI Protection	
	PKG 3Z-*/S760 PKW 3Z-*/S760	PSG 3-*/S760 PSW 3-*/S760	AWM, PVC Black, 3x24 AWG, 105 °C, 4.2 mm OD, Cable #RF50585-M, Flexlife	

* Length in meters. Standard cable lengths are 2, 4, 5, 6, 8 and 10 meters.

** Locking sleeve material is POM. "PKG..Z".

We reserve the right to make technical alterations without prior notice.

4-Wire Cordsets, Snap Lock (Locking Sleeve)

- NEMA 1, 3, 4, 6P
- IEC IP67 Protection
- 125 V, 2 A



We reserve the right to make technical alterations without prior notice.

Connector Style	Female Part Number	Male Part Number	Features	Pinout
<p>PKG ..Z**</p>	PKG 4Z-* PKW 4Z-*	PSG 4-* PSW 4-*	AWM, PVC Yellow, 4x26 AWG, 105 °C, 4.4 mm OD, Cable #RF50697-*M, Flexlife®	
<p>PKW ..Z**</p>	PKG 4Z-*/S90 PKW 4Z-*/S90	PSG 4-*/S90 PSW 4-*/S90	AWM, TPU Black, 4x26 AWG, 90 °C, 4.2 mm OD, Cable #RF50586-*M, Cut/Abrasion Immune	<p>Female</p>
<p>PKG ..Z**</p>	PKG 4Z-*/S90/S101 PKW 4Z-*/S90/S101	PSG 4-*/S90/S101 PSW 4-*/S90/S101	AWM, TPU Black, 4x26 AWG, 90 °C, 4.4 mm OD, Cable #RF50935-*M, Cut/Abrasion Immune, Flexlife-20, High Flex - Over 20 Million Cycles	<p>1. BN 2. WH 3. BU 4. BK</p>
<p>PSG ..</p>	PKG 4Z-*/S90/S618 PKW 4Z-*/S90/S618	PSG 4-*/S90/S101 PSW 4-*/S90/S101	AWM, TPU Black, 4x26 AWG, 90 °C, 4.2 mm OD, Cable #RF50602-*M, Cut/Abrasion Immune, EMI/RFI Protection	
<p>PSG ..</p>	PKG 4Z-*/S760 PKW 4Z-*/S760	PSG 4-*/S760 PSW 4-*/S760	AWM, PVC Black, 4x26 AWG, 105 °C, 4.4 mm OD, Cable #RF50870-*M, Flexlife	<p>Male</p>
<p>PSW ..</p>	PKG 4Z-*/S90/S653 PKW 4Z-*/S90/S653	PSG 4-*/S90/S653 PSW 4-*/S90/S653	AWM, TPU Black, 3x24 AWG, 90 °C, 4.2 mm OD, Cable #RF50601-*M, Cut/Abrasion Immune, EMI/RFI Protection	<p>1. BN 2. Drain 3. BU 4. BK</p>

* Length in meters. Standard cable lengths are 2, 4, 5, 6, 8 and 10 meters.

** Locking sleeve material is POM.. "PKG..Z".

Cordsets

6-Wire Cordsets, Snap Lock (Locking Sleeve)

- NEMA 1, 3, 4, 6P
- IEC IP67 Protection
- 125 V, 2 A



Connector Style	Female Part Number	Male Part Number	Features	Pinout
<p>PKG ..Z**</p>	PKG 6Z-* PKW 6Z-*	PSG 6-* PSW 6-*	AWM, PVC Yellow, 6x26 AWG, 105 °C, 4.5 mm OD, Cable #RF50734-*M, Flexlife®, UL Listed	<p>Female</p> <p>1. BN 2. WH 3. BU 4. BK 5. GY 6. PK</p> <p>Male</p>
<p>PKW ..Z**</p>	PKG 6Z-*/S90 PKW 6Z-*/S90	PSG 6-*/S90 PSW 6-*/S90	AWM, TPU Black, 6x26 AWG, 90 °C, 4.2 mm OD, Cable #RF50735-*M, Cut/Abrasion Immune	
<p>PSG ..</p>	PKG 6Z-*/S90/S618 PKW 6Z-*/S90/S618	PSG 6-*/S90/S618 PSW 6-*/S90/S618	AWM, TPU Black, 6x26 AWG, 90 °C, 4.2 mm OD, Cable #RF51144-M, Cut/Abrasion Immune EMI/RFI Protection	
<p>PSW ..</p>	PKG 6Z-*/S760 PKW 6Z-*/S760	PSG 6-*/S760 PSW 6-*/S760	AWM, PVC Black, 6x26 AWG, 105 °C, 4.5 mm OD, Cable #RF51083-*M, Flexlife®, UL Listed	

* Length in meters. Standard cable lengths are 2, 4, 5, 6, 8 and 10 meters.

** Locking sleeve material is POM.."PKG..Z".

We reserve the right to make technical alterations without prior notice.

3-Wire Cordsets, Threaded Coupling Nut

- NEMA 1, 3, 4, 6P
- IEC IP67 Protection
- 125 V, 4 A



Cordsets

We reserve the right to make technical alterations without prior notice.

Connector Style	Female Part Number	Male Part Number	Features	Pinout
<p>PKG ..Z**</p>	PKG 3M-* PKW 3M-*	PSG 3M-* PSW 3M-*	AWM, PVC Yellow, 3x24 AWG, 105 °C, 4.4 mm OD, Cable #RF50642-*M, Flexlife®	Female 1. BN 3. BU 4. BK
<p>PKG 3M-*/S90 PKW 3M-*/S90</p>	PKG 3M-*/S90 PKW 3M-*/S90	PSG 3M-*/S90 PSW 3M-*/S90	AWM, TPU Black, 3x24 AWG, 90 °C, 4.2 mm OD, Cable #RF50587-*M, Cut/Abrasion Immune	
<p>PKG 3M-*/S90/S101 PKW 3M-*/S90/S101</p>	PKG 3M-*/S90/S101 PKW 3M-*/S90/S101	PSG 3M-*/S90/S101 PSW 3M-*/S90/S101	AWM, TPU Black, 3x24 AWG, 90 °C, 4.4 mm OD, Cable #RF51166-*M, Cut/Abrasion Immune, Flexlife-20, High Flex - Over 20 Million Cycles	
<p>PSG ..M**</p>	PKG 3M-*/S90/S618 PKW 3M-*/S90/S618	PSG 3M-*/S90/S618 PSW 3M-*/S90/S618	AWM, TPU Black, 3x24 AWG, 90 °C, 4.2 mm OD, Cable #RF50601-*M, Cut/Abrasion Immune, EMI/RFI Protection	Male 1. BN 3. BU 4. Drain
<p>PKG 3M-*/S1587 PKW 3M-*/S1587</p>	PKG 3M-*/S1587 PKW 3M-*/S1587	PSG 3M-*/S1587 PSW 3M-*/S1587	AWM, TPE Yellow, 3x24 AWG, 105 °C, 4.4 mm OD, Cable #RF51271-*M, Weldlife®, Weld Flash Immune	
<p>PKG 3M-*/S760 PKW 3M-*/S760</p>	PKG 3M-*/S760 PKW 3M-*/S760	PSG 3M-*/S760 PSW 3M-*/S760	AWM, PVC Black, 3x24 AWG, 4.2 mm OD, Cable #RF50585-M, Flexlife	
<p>PKG 3M-*/S90/S1084 PKW 3M-*/S90/S1084</p>	PKG 3M-*/S90/S1084 PKW 3M-*/S90/S1084	PSG 3M-*/S90/S1084 PSW 3M-*/S90/S1084	AWM, TPU Black, 2x24 AWG, 90 °C, 4.2 mm OD, Cable #RF51197-*M, Cut/Abrasion Immune, Shielded	1. BN 3. BU 4. BK
<p>PSG 3F ..**</p>		PSG 3F-*	AWM, PVC Yellow, 3x24 AWG, 105 °C, 4.4 mm OD, Cable #RF50642-*M, Fixed coupling nut	

* Length in meters. Standard cable lengths are 2, 4, 5, 6, 8 and 10 meters.

** Standard coupling material is nickel plated brass.. "PKG..M"; "PKG..M" indicates stainless steel.

4-Wire Cordsets, Threaded Coupling Nut

- NEMA 1, 3, 4, 6P
- IEC IP67 Protection
- 125 V, 4 A



Connector Style	Female Part Number	Male Part Number	Features	Pinout
<p>PKG ..M**</p>	PKG 4M-* PKW 4M-*	PSG 4M-* PSW 4M-*	AWM PVC Yellow, 4x26 AWG, 105 °C, 4.4 mm OD, Cable #RF50697-*M, Flexlife®	
<p>PKW ..M**</p>	PKG 4M-*/S90 PKW 4M-*/S90	PSG 4M-*/S90 PSW 4M-*/S90	AWM TPU Black, 4x26 AWG, 90 °C, 4.2 mm OD, Cable #RF50586-*M, Cut/Abrasion Immune	<p>Female</p>
<p>PKG ..M**</p>	PKG 4M-*/S90/S101 PKW 4M-*/S90/S101	PSG 4M-*/S90/S101 PSW 4M-*/S90/S101	AWM TPU Black, 4x26 AWG, 90 °C, 4.4 mm OD, Cable #RF50935-*M, Cut/Abrasion Immune, Flexlife-20, High Flex - Over 20 Million Cycles	
<p>PSG ..M**</p>	PKG 4M-*/S90/S618 PKW 4M-*/S90/S618	PSG 4M-*/S90/S618 PSW 4M-*/S90/S618	AWM TPU Black, 4x26 AWG, 90 °C, 4.2 mm OD, Cable #RF50602-*M, Cut/Abrasion Immune, EMI/RFI Protection	<p>1. BN 2. WH 3. BU 4. BK</p>
<p>PSW ..M**</p>	PKG 4M-*/S760 PKW 4M-*/S760	PSG 4M-*/S760 PSW 4M-*/S760	AWM PVC Black, 4x26 AWG, 105 °C, 4.4 mm OD, Cable #RF50870-*M, Flexlife	<p>Male</p>
	PKG 4M-*/S90/S653 PKW 4M-*/S90/S653	PSG 4M-*/S90/S653 PSW 4M-*/S90/S653	AWM TPU Black, 3x24 AWG, 90 °C, 4.2 mm OD, Cable #RF50601-*M, Cut/Abrasion Immune, EMI/RFI Protection	

We reserve the right to make technical alterations without prior notice.

* Length in meters. Standard cable lengths are 2, 4, 5, 6, 8 and 10 meters.
 ** Standard coupling material is nickel plated brass. "PKG..M"; "PKG..M" indicates stainless steel.

6-Wire Cordsets, Threaded Coupling Nut

- NEMA 1, 3, 4, 6P
- IEC IP67 Protection
- 125 V, 2 A



Connector Style	Female Part Number	Male Part Number	Features	Pinout
<p>PKG ..M**</p>	<p>PKG 6M-* PKW 6M-*</p>	<p>PSG 6M-* PSW 6M-*</p>	<p>AWM PVC Yellow, 6x26 AWG, 105 °C, 4.5 mm OD, Cable #RF50734-*M, Flexlife®, UL Listed</p>	<p>Female</p> <p>1. BN 2. WH 3. BU 4. BK 5. GY 6. PK</p> <p>Male</p>
<p>PKW ..M**</p>	<p>PKG 6M-*/S90 PKW 6M-*/S90</p>	<p>PSG 6M-*/S90 PSW 6M-*/S90</p>	<p>AWM TPU Black, 6x26 AWG, 90 °C, 4.2 mm OD, Cable #RF50735-*M, Cut/Abrasion Immune</p>	
<p>PSG ..M**</p>	<p>PKG 6M-*/S760 PKW 6M-*/S760</p>	<p>PSG 6M-*/S760 PSW 6M-*/S760</p>	<p>AWM PVC Black, 6x26 AWG, 105 °C, 4.5 mm OD, Cable #RF51083-*M, Flexlife, UL Listed</p>	
<p>PSW ..M**</p>	<p>PKG 6M-*/S90/S618 PKW 6M-*/S90/S618</p>	<p>PSG 6M-*/S90/S618 PSW 6M-*/S90/S618</p>	<p>AWM TPU Black, 6x26 AWG, 90 °C, 4.2 mm OD, Cable #RF51144-*M, Cut/ Abrasion Immune EMI/RFI Protection</p>	

We reserve the right to make technical alterations without prior notice.

* Length in meters. Standard cable lengths are 2, 4, 5, 6, 8 and 10 meters.
 ** Standard coupling material is nickel plated brass. "PKG..M"; "PKG..M" indicates stainless steel.

3 and 4-Wire Cordsets, Threaded Coupling Nut, Shielded

- Shield to Coupling Nut
- IEC IP67 Protection
- 125 V, 4 A (3-pin), 2 A (4-pin)



Connector Style	Female Part Number	Male Part Number	Features	Pinout
<p>PKG ..M**</p>	<p>PKGS 3M-* PKWS 3M-*</p>	<p>PSGS 3M-* PSWS 3M-*</p>	<p>AWM, PVC Yellow, 3x24 AWG, 105 °C, 5.1 mm OD, Cable #RF51422-*M, RFI/EMI Shielding Tied to Coupling Nut</p>	<p>Female</p> <p>1. BN 3. BU 4. BK</p>
<p>PKW ..M**</p>	<p>PKGS 3M-*/S90 PKWS 3M-*/S90</p>	<p>PSGS 3M-*/S90 PSWS 3M-*/S90</p>	<p>AWM, TPU Black, 3x24 AWG, 90 °C, 5.1 mm OD, Cable #RF51423-*M, RFI/EMI Shielding Tied to Coupling Nut</p>	<p>Male</p>
<p>PSG ..M**</p>	<p>PKGS 4M-* PKWS 4M-*</p>	<p>PSGS 4M-* PSWS 4M-*</p>	<p>AWM, PVC Yellow, 4x26 AWG, 105 °C, 5.1 mm OD, Cable #RF51424-*M, RFI/EMI Shielding Tied to Coupling Nut</p>	<p>Female</p> <p>1. BN 2. WH 3. BU 4. BK</p>
<p>PSW ..M**</p>	<p>PKGS 4M-*/S90 PKWS 4M-*/S90</p>	<p>PSGS 4M-*/S90 PSWS 4M-*/S90</p>	<p>AWM, TPU Black, 4x26 AWG, 90 °C, 5.1 mm OD, Cable #RF51425-*M, RFI/EMI Shielding Tied to Coupling Nut</p>	<p>Male</p>

We reserve the right to make technical alterations without prior notice.

* Length in meters. Standard cable lengths are 2, 4, 6, 8 and 10 meters. Consult factory for other lengths.

** Standard coupling material is nickel plated brass.

3 and 4-Wire Cordsets, with LEDs, Snap Lock (Locking Sleeve)

- NEMA 1, 3, 4, 6P
- IEC IP67 Protection
- 10-30 VDC, 4 A (3-pin), 2 A (4-pin)



Connector Style	Female Part Number	Features	Pinout
	PKW 3Z-P7X2-*	AWM PVC Yellow, 3x24 AWG, 105 °C, 4.4 mm OD, Cable #RF50642- <i>*M</i> , PNP Signal, Flexlife®	Female 1. BN 3. BU 4. BK
	PKW 3Z-P7X2-*/S90	AWM TPU Black, 3x24 AWG, 90 °C, 4.2 mm OD, Cable #RF50587- <i>*M</i> , PNP Signal, Cut/Abrasion Immune	
	PKW 3Z-P7X2-*/S90/S618	AWM TPU Black, 3x24 AWG, 90 °C, 4.2 mm OD, Cable #RF50601- <i>*M</i> , PNP Signal, Cut/Abrasion Immune, EMI/RFI Protection	
	PKW 3Z-P7X2-*/S90/S101	AWM TPU Black, 3x24 AWG, 90 °C, 4.4 mm OD, Cable #RF51166- <i>*M</i> , PNP Signal, Cut/Abrasion Immune, Flexlife-20, High Flex - over 20 Million Cycles	Female 1. BN 3. BU 4. BK
	PKW 3Z-N7X2-*	AWM PVC Yellow, 3x24 AWG, 105 °C, 4.4 mm OD, Cable #RF50642- <i>*M</i> , NPN Signal, Flexlife	
	PKW 3Z-N7X2-*/S90	AWM TPU Black, 3x24 AWG, 90 °C, 4.2 mm OD, Cable #RF50587- <i>*M</i> , NPN Signal, Cut/Abrasion Immune	
	PKW 3Z-N7X2-*/S90/S618	AWM TPU Black, 3x24 AWG, 90 °C, 4.2 mm OD, Cable #RF50601- <i>*M</i> , NPN Signal, Cut/Abrasion Immune, EMI/RFI Protection	Female 1. BN 3. BU 4. BK
	PKW 3Z-N7X2-*/S90/S101	AWM TPU Black, 3x24 AWG, 90 °C, 4.4 mm OD, Cable #RF51166- <i>*M</i> , NPN Signal, Cut/Abrasion Immune, Flexlife-20, High Flex - over 20 Million Cycles	
	PKW 4Z-P7X2-*	AWM PVC Yellow, 4x26 AWG, 105 °C, 4.4 mm OD, Cable #RF50697- <i>*M</i> , PNP Signal, Flexlife	
PKW 4Z-P7X2-*/S90	AWM TPU Black, 4x26 AWG, 90 °C, 4.2 mm OD, Cable #RF50586- <i>*M</i> , PNP Signal, Cut/Abrasion Immune	Male 1. BN 2. WH 3. BU 4. BK	
PKW 4Z-P7X2-*/S90/S101	AWM TPU Black, 4x26 AWG, 90 °C, 4.4 mm OD, Cable #RF50935- <i>*M</i> , PNP Signal, Cut/Abrasion Immune, Flexlife-20, High Flex - Over 20 Million Cycles		

We reserve the right to make technical alterations without prior notice.

* Length in meters. Standard cable lengths are 2, 4, 6, 8 and 10 meters.

** Locking sleeve material is POM..“PKW..Z”.

Cordsets

3 and 4-Wire Cordsets, Threaded Coupling Nut, Shielded

- NEMA 1, 3, 4, 6P
- IEC IP67 Protection
- 10-30 VDC, 4 A



Connector Style	Female Part Number	Male Part Number	Features	Pinout
	PKW 3M-P7X2-*	PSW 3M-P7X2-*	AWM PVC Yellow, 3x24 AWG, 105 °C, 4.4 mm OD, Cable #RF50642- <i>*M</i> , PNP Signal, Flexlife®	<p style="text-align: center;">Female</p> <p>1. BN 3. BU 4. BK</p>
	PKW 3M-P7X2-*/S90	PSW 3M-P7X2-*/S90	AWM TPU Black, 3x24 AWG, 90 °C, 4.2 mm OD, Cable #RF50587- <i>*M</i> , PNP Signal, Cut/Abrasion Immune	
	PKW 3M-P7X2-*/S90/S101	PSW 3M-P7X2-*/S90/S101	AWM TPU Black, 3x24 AWG, 90 °C, 4.4 mm OD, Cable #RF51166- <i>*M</i> , PNP Signal, Cut/Abrasion Immune, Flexlife-20, High Flex - over 20 Million Cycles	
	PKW 3M-P7X2-*/S90/S618		AWM TPU Black, 3x24 AWG, 90 °C, 4.2 mm OD, Cable #RF50601- <i>*M</i> , PNP Signal, Cut/Abrasion Immune, EMI/RFI Protection	
	PKW 3M-N7X2-*		AWM PVC Yellow, 3x24 AWG, 105 °C, 4.4 mm OD, Cable #RF50642- <i>*M</i> , NPN Signal, Flexlife	
	PKW 3M-N7X2-*/S90		AWM TPU Black, 3x24 AWG, 90 °C, 4.2 mm OD, Cable #RF50587- <i>*M</i> , NPN Signal, Cut/Abrasion Immune	
	PKW 3M-N7X2-*/S90/S101		AWM TPU Black, 3x24 AWG, 90 °C, 4.4 mm OD, Cable #RF51166- <i>*M</i> , NPN Signal, Cut/Abrasion Immune, Flexlife-20, High Flex - over 20 Million Cycles	
	PKW 3M-N7X2-*/S90/S618		AWM TPU Black, 3x24 AWG, 90 °C, 4.2 mm OD, Cable #RF50601- <i>*M</i> , NPN Signal, Cut/Abrasion Immune, EMI/RFI Protection	

We reserve the right to make technical alterations without prior notice.

* Length in meters. Standard cable lengths are 2, 4, 6, 8 and 10 meters. Consult factory for other lengths.

** Standard coupling material is nickel plated brass.

4-Wire Cordsets, with LEDs, Threaded Coupling Nut

- NEMA 1, 3, 4, 6P
- IEC IP67 Protection
- 10-30 VDC, 2 A



Connector Style	Female Part Number	Features	Pinout
	PKW 4M-P7X2-*	AWM PVC Yellow, 4x26 AWG, 105 °C, 4.4 mm OD, Cable #RF50697-*M, PNP Signal, Flexlife®	<p>Female</p> <p>1. BN 2. WH 3. BU 4. BK</p>
	PKW 4M-P7X2-*/S90	AWM TPU Black, 4x26 AWG, 90 °C, 4.2 mm OD, Cable #RF50586-*M, PNP Signal, Cut/Abrasion Immune	
	PKW 4M-P7X2-*/S90/S101	AWM TPU Black, 4x26 AWG, 90 °C, 4.4 mm OD, Cable #RF50935-*M, PNP Signal, Cut/Abrasion Immune, Flexlife-20, High Flex - over 20 Million Cycles	
	PKW 4M-P7X2-*/S90/S618	AWM TPU Black, 4x26 AWG, 90 °C, 4.2 mm OD, Cable #RF50602-*M, PNP Signal, Cut/Abrasion Immune, EMI/RFI Protection	

* Length in meters. Standard cable lengths are 2, 4, 6, 8 and 10 meters.
 ** Locking sleeve material is POM.. "PKW..Z".

We reserve the right to make technical alterations without prior notice.

Cordsets

3 and 4-Wire Spiral Cordsets, Snap Lock (Locking Sleeve)

- NEMA 1, 3, 4, 6P
- IEC IP67 Protection
- 125 V, 4 A (3-pin) and 2 A (4-pin)



Connector Style	Female Part Number	Male Part Number	Features	Pinout
<p>PKG ..Z**</p>	<p>PKG 3Z-3/S90-SP PKW 3Z-3/S90-SP</p>	<p>PSG 3-3/S90-SP PSW 3-3/S90-SP</p>	<p>AWM TPU Black, 4x26 AWG, 90 °C, 125 VAC/VDC, 4 A, 4.2 mm OD, for repetitive motion 3-wire applications, snap lock coupling nut</p>	<p>Female</p>
<p>PKW ..Z**</p>				<p>Male</p>
<p>PSG ..</p>	<p>PKG 4Z-3/S90-SP PKW 4Z-3/S90-SP</p>	<p>PSG 4-3/S90-SP PSW 4-3/S90-SP</p>	<p>AWM TPU Black, 4x26 AWG, 90 °C, 125 VAC/VDC, 2 A, 4.2 mm OD, for repetitive motion 4-wire applications, snap lock coupling nut</p>	<p>Female</p>
<p>PSW ..</p>				<p>Male</p>

We reserve the right to make technical alterations without prior notice.

* Length in meters. Standard cable length is 3 meters. Consult factory for other lengths.

** Locking sleeve material is POM.. "PKG(W)..Z".

3 and 4-Wire Spiral Cordsets, Threaded Coupling Nut

- NEMA 1, 3, 4, 6P
- IEC IP67 Protection
- 125 VAC/VDC, 4 A (3-pin) and 2 A (4-pin)





Connector Style	Female Part Number	Male Part Number	Features	Pinout
<p>PKG ..Z**</p>	<p>PKG 3M-3/S90-SP PKW 3M-3/S90-SP</p>	<p>PSG 3M-3/S90-SP PSW 3M-3/S90-SP</p>	<p>AWM TPU Black, 4x26 AWG, 90 °C, 125 VAC/VDC, 4 A, 4.2 mm OD, for repetitive motion 3-wire applications, threaded coupling nut</p>	<p>Female</p>
<p>PKW ..Z**</p>				<p>Male</p>
<p>PSG ..</p>	<p>PKG 4M-3/S90-SP PKW 4M-3/S90-SP</p>	<p>PSG 4M-3/S90-SP PSW 4M-3/S90-SP</p>	<p>AWM TPU Black, 4x26 AWG, 90 °C, 125 VAC/VDC, 2 A, 4.2 mm OD, for repetitive motion 4-wire applications, threaded coupling nut</p>	<p>Female</p>
<p>PSW ..</p>				<p>Male</p>

We reserve the right to make technical alterations without prior notice.

* Length in meters. Standard cable length is 3 meters. Consult factory for other lengths.
 ** Locking sleeve material is POM.. "PKW..Z".

Cordsets

Mounting Style	Image	Panel Thread Types	Page
Front Mount		<u>M8</u>	<u>C17</u>
Rear Mount		<u>M8</u>	<u>C18</u>
PCB Mount		<u>M8 with PCB Pins</u>	<u>C19</u>
		<u>7/16-20 with Header Pins</u>	<u>C19</u>
		<u>M8 with Header Pins</u>	<u>C20</u>

We reserve the right to make technical alterations without prior notice.

3, 4 and 6-Wire Receptacles, Front Mount

- NEMA 1, 3, 4, 6P
- IEC IP67 Protection



We reserve the right to make technical alterations without prior notice.

Housing Style	Female Part Number	Male Part Number	Features	Pinout
<p>MFKS 3..</p> <p>Typical panel cutout is 8.2 mm</p>	MFKS 3-*		3x24 AWG, 105 °C, 125 V, 4 A, mates with 3-pin threaded female cordsets	<p>Female</p> <p>1. BN 3. BU 4. BK</p> <p>Male</p>
		MFS 3-*		3x24 AWG, 105 °C, 125 V, 4 A, mates with 3-pin snap lock female cordsets
<p>MFKS 4..</p> <p>Typical panel cutout is 8.2 mm</p>	MFKS 4-*		4x24 AWG, 105 °C, 125 V, 4 A, mates with 4-pin threaded female cordsets	<p>Female</p> <p>1. BN 2. WH 3. BU 4. BK</p> <p>Male</p>
		MFS 4-*		4x24 AWG, 105 °C, 125 V, 4 A, mates with 4-pin snap lock female cordsets
<p>MFKS 6..</p> <p>Typical panel cutout is 8.2 mm</p>	MFKS 6-*		6x24 AWG, 105 °C, 125 V, 2 A, mates with 6-pin threaded female cordsets	<p>Female</p> <p>1. BN 2. WH 3. BU 4. BK 5. GY 6. PK</p> <p>Male</p>
		MFS 6-*		6x24 AWG, 105 °C, 125 V, 2 A, mates with 6-pin snap lock female cordsets

* Length in meters. Standard lead length is 0.2 meters. Consult factory for other lengths. Standard housing material is nickel plated brass .. "MFK(S).."; "MFK(S)V.." indicates stainless steel.

Receptacles

3, 4 and 6-Wire Receptacles, Rear Mount

- NEMA 1, 3, 4, 6P
- IEC IP67 Protection



Housing Style	Male Part Number	Features	Pinout	
<p>Typical panel cutout is 8.2 mm</p>	MFS 3F-*	3x24 AWG, 105 °C, 125 V, 4 A, mates with 3-pin snap lock or threaded female cordsets, rear mount	<p>1. BN 3. BU 4. BK</p>	
	MFS 4F-*	4x24 AWG, 105 °C, 125 V, 4 A, mates with 4-pin snap lock or threaded female cordsets, rear mount	<p>1. BN 2. WH 3. BU 4. BK</p>	
	MFS 6F-*	6x24 AWG, 105 °C, 125 V, 2 A, mates with 6-pin snap lock or threaded female cordsets, rear mount	<p>1. BN 2. WH 3. BU 4. BK 5. GY 6. PK</p>	
	<p>Typical panel cutout is 8.2 x 7.1 mm</p>	MFSS 3-*	3x24 AWG, 105 °C, 125 V, 4 A, mates with 3-pin snap lock or threaded female cordsets, front mount	<p>1. BN 3. BU 4. BK</p>
		MFSS 4-*	4x24 AWG, 105 °C, 125 V, 4 A, mates with 4-pin snap lock or threaded female cordsets, front mount	<p>1. BN 2. WH 3. BU 4. BK</p>
		MFSS 6-*	4x24 AWG, 105 °C, 125 V, 4 A, mates with 4-pin snap lock or threaded female cordsets, front mount	<p>1. BN 2. WH 3. BU 4. BK 5. GY 6. PK</p>

We reserve the right to make technical alterations without prior notice.

* Length in meters. Standard lead length is 0.2 meters. Consult factory for other lengths.
Standard housing material is nickel plated brass .. "MFS(S).."; "MFS(S)V.." indicates stainless steel.

3, 4 and 6-Pin Receptacles with PCB Pins

- NEMA 1, 3, 4, 6P
- IEC IP67 Protection



We reserve the right to make technical alterations without prior notice.

Housing Style	Female Part Number	Features	Pinout
<p>MFKS .. F-PCBF</p>	MFKS 3F-PCBF	PCB Pins, 85 °C, 60 V, 4 A, mates with 3-pin threaded male cordsets	<p>Female</p>
	MFKS 4F-PCBF	PCB Pins, 85 °C, 30 V, 4 A, mates with 4-pin threaded male cordsets	<p>Female</p>
<p>WMFK .. F-PCB</p>	WMFK 3F-PCB	PCB Pins, 80 °C, 60 VAC/75 VDC, 4 A, mates with 3-pin threaded male cordsets	<p>Female</p>
	WMFK 4F-PCB	PCB Pins, 80 °C, 30 VAC/36 VDC, 4 A, mates with 4-pin threaded male cordsets	<p>Female</p>
	WMFK 6F-PCB	PCB Pins, 80 °C, 24 VDC, 1 A, mates with 6-pin threaded male cordsets	<p>Female</p>

Standard housing material is nickel plated brass.

MFKS 3F-PCBF

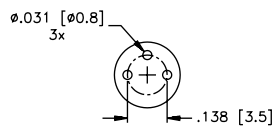

MFKS 4F-PCBF

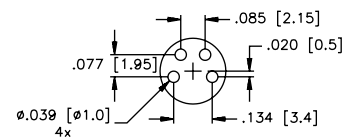

WMFK 3F-PCB

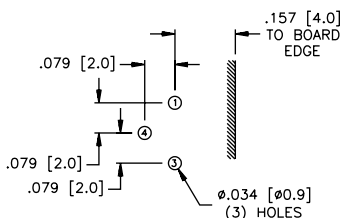

WMFK 4F-PCB

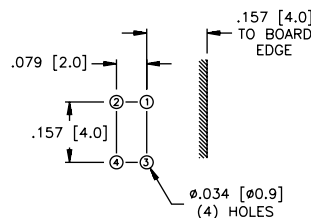

WMFK 6F-PCB

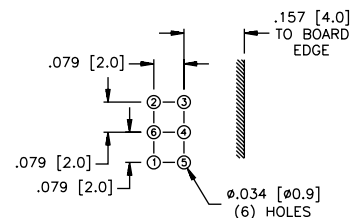

3, 4 and 6-Pin Receptacles with PCB Pins

- NEMA 1, 3, 4, 6P
- IEC IP67 Protection



Housing Style	Male Part Number	Features	Pinout
<p>MFKS .. F-PCBF</p>	WMFS 3-PCB	PCB Pins, 80 °C, 60 VAC/75 VDC, 4 A, mates with 3-pin snap lock or threaded female cordsets	<p>Male</p>
	WMFS 4-PCB	PCB Pins, 80 °C, 30 VAC/36 VDC, 4 A, mates with 4-pin snap lock or threaded female cordsets	<p>Male</p>
<p>WMFK .. F-PCBF</p>	WMFS 6-PCB	PCB Pins, 80 °C, 24 VDC, 1 A, mates with 6-pin snap lock or threaded female cordsets	<p>Male</p>
	WMFS 3F-PCB	PCB Pins, 80 °C, 75 VDC, 4 A, mates with 3-pin snap lock or threaded female cordsets	<p>Male</p>
	WMFS 4F-PCB	PCB Pins, 80 °C, 36 VDC, 4 A, mates with 4-pin snap lock or threaded female cordsets	<p>Male</p>
	WMFS 6F-PCB	PCB Pins, 80 °C, 24 VDC, 1 A, mates with 6-pin snap lock or threaded female cordsets	<p>Male</p>

We reserve the right to make technical alterations without prior notice.

Standard housing material is nickel plated brass.

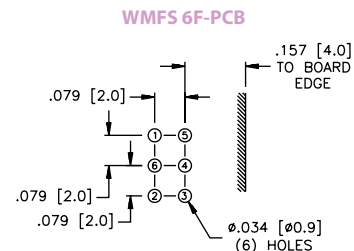
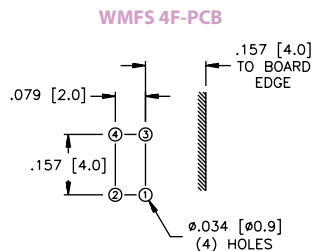
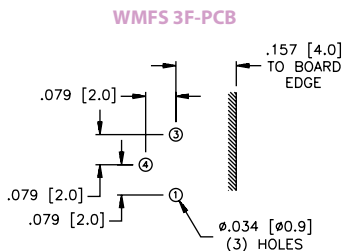
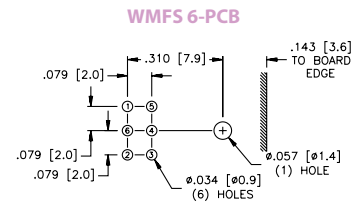
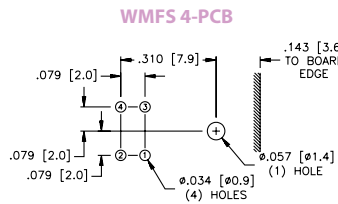
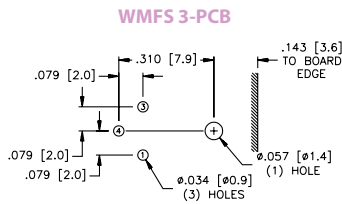

3 and 4-Pin Receptacles with PCB Pins and Mounting Bracket

- IEC IP67 Protection



Housing Style	Female Part Number	Features	Pinout
<p>MFKSH .. F-PCB</p>	MFKSH 3F-PCB	PCB Pins, 85 °C, 60 V, 4 A, mates with 3-pin threaded male cordsets	<p>Female</p>
<p>MFKSH 4F-PCB</p>	MFKSH 4F-PCB	PCB Pins, 85 °C, 30 V, 4 A, mates with 4-pin threaded male cordsets	<p>Female</p>
<p>MFKSHL .. F-PCB</p>	MFKSHL 3F-PCB	PCB Pins, Long Bracket, 85 °C, 60 V, 4 A, mates with 3-pin threaded male cordsets	<p>Female</p>
<p>MFKSHL 4F-PCB</p>	MFKSHL 4F-PCB	PCB Pins, Long Bracket, 85 °C, 30 V, 4 A, mates with 4-pin threaded male cordsets	<p>Female</p>
<p>WMFKSH .. F-PCB</p>	WMFKSH 3F-PCB	PCB Pins, 85 °C, 60 V, 4 A, mates with 3-pin threaded male cordsets	<p>Female</p>
<p>WMFKSH 4F-PCB</p>	WMFKSH 4F-PCB	PCB Pins, 85 °C, 30 V, 4 A, mates with 4-pin threaded male cordsets	<p>Female</p>

We reserve the right to make technical alterations without prior notice.

Receptacles

Standard housing material is nickel plated brass.

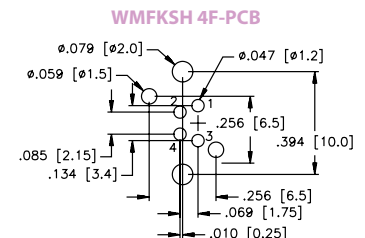
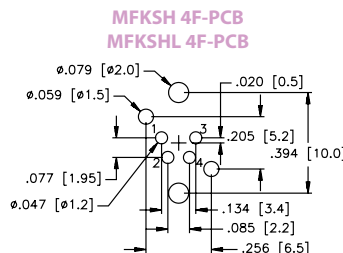
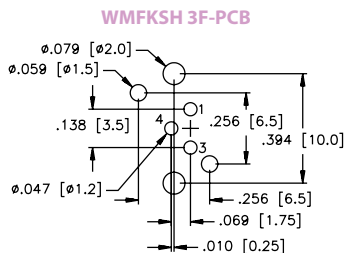
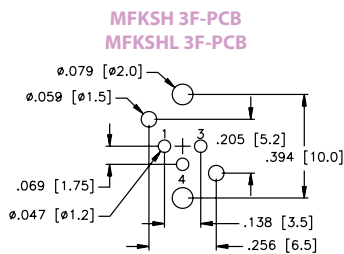

3, 4 and 6-Pin Receptacles, Rear Mount with Solder Cups

- NEMA 1, 3, 4, 6P
- IEC IP67 Protection



Housing Style	Female Part Number	Features	Pinout
	MFKS 3F	Solder Cups, accepts up to 22 AWG conductors, 80 °C, 125 V, 4 A, mates with 3-pin threaded male cordsets	<p>Female</p>
	MFKS 4F	Solder Cups, accepts up to 22 AWG conductors, 80 °C, 125 V, 2 A, mates with 4-pin threaded male cordsets	<p>Female</p>
	MFKS 6F	Solder Cups, accepts up to 24 AWG conductors, 80 °C, 125 V, 2 A, mates with 6-pin threaded male cordsets	<p>Female</p>

Standard housing material is nickel plated brass.

We reserve the right to make technical alterations without prior notice.

3, 4 and 6-Pin Feed-Thru Receptacles

- Female to Male Receptacles
- NEMA 1, 3, 4, 6P
- IEC IP67 Protection



Housing Style	Part Number	Features	Pinout
<p>MFSV MFKV ..</p>	MFSV MFKV 3/M8	3-conductor, 80 °C, 125 V, 4 A, mates with 3-pin threaded cordsets	<p>Female</p> <p>Male</p>
<p>MFSV MFKV ..</p>	MFSV MFKV 4/M8	4-conductor, 80 °C, 125 V, 2 A, mates with 4-pin threaded cordsets	<p>Female</p> <p>Male</p>
<p>MFSV MFKV ..</p>	MFSV MFKV 6/M8	6-conductor, 80 °C, 125 V, 2 A, mates with 6-pin threaded cordsets	<p>Female</p> <p>Male</p>

Standard housing material is nickel plated brass.

We reserve the right to make technical alterations without prior notice.

Receptacles

- IEC IP67 Protection



Housing Style	Female Part Number	Male Part Number	Features	Pinout
<p>B 513(4)1-0</p>	B 5131-0	BS 5131-0	PBT, Black, accepts 3-5 mm cable diameter, solder terminals, accepts up to 24 AWG conductors, 85 °C, 60 VAC/75 VDC, 4 A, mates with 4-pin threaded cordsets and receptacles	<p>Female</p> <p>Male</p>
<p>BS 513(4)1-0</p>	B 5141-0	BS 5141-0	PBT, Black, accepts 3-5 mm cable diameter, solder terminals, accepts up to 24 AWG conductors, 85 °C, 30 VAC/36 VDC, 4 A, mates with 4-pin threaded cordsets and receptacles	<p>Female</p> <p>Male</p>
<p>B 513(4)3-0</p>	B 5133-0	BS 5133-0	PBT, Black, accepts 3-5 mm cable diameter, screw terminals, accepts up to 22 AWG conductors, 85 °C, 60 VAC/75 VDC, 4 A, mates with 3-pin threaded cordsets and receptacles	<p>Female</p> <p>Male</p>
<p>BS 513(4)3-0</p>	B 5143-0	BS 5143-0	PBT, Black, accepts 3-5 mm cable diameter, screw terminals, accepts up to 22 AWG conductors, 85 °C, 60 VAC/75 VDC, 4 A, mates with 4-pin threaded cordsets and receptacles	<p>Female</p> <p>Male</p>

We reserve the right to make technical alterations without prior notice.

3 and 4-Pin Field Wireable Connectors, Standard

- IEC IP67 Protection



We reserve the right to make technical alterations without prior notice.

Housing Style	Female Part Number	Male Part Number	Features	Pinout
<p>BS 513(4)2-0</p>		BS 5132-0	PBT, Black, accepts 3-5 mm cable diameter, solder terminals, accepts up to 26 AWG conductors, 85 °C, 60 VAC/75 VDC, 4 A, mates with 3-pin female snap-lock cordsets, receptacles and junction boxes and threaded cordsets	<p>Male</p>
		BS 5142-0	PBT, Black, accepts 3-5 mm cable diameter, solder terminals, accepts up to 26 AWG conductors, 85 °C, 60 VAC/75 VDC, 2 A, mates with 3-pin female snap-lock cordsets, receptacles and junction boxes and threaded cordsets	<p>Male</p>
<p>B 523(4)1-0</p>	B 5231-0	BS 5231-0	PBT, Black, Accepts 3-5 mm cable diameter, solder terminals, accepts up to 24 AWG conductors, 85 °C, 60 VAC/75 VDC, 4 A, mates with 3-pin threaded cordsets and receptacles	<p>Female</p> <p>Male</p>
<p>BS 523(4)1-0</p>	B 5241-0	BS 5241-0	PBT, Black, accepts 3-5 mm cable diameter, solder terminals, accepts up to 24 AWG conductors, 85 °C, 30 VAC/36 VDC, 4 A, mates with 4-pin threaded cordsets and receptacles	<p>Female</p> <p>Male</p>

Field Wireables

3 and 4-Pin Field Wireable Connectors, IDC

- Insulation Displacement Technology
- No Conductor Stripping Required
- IEC IP67 Protection



Housing Style	Female Part Number		Features	Pinout
<p>B 513(4)6-0</p>	B 5136-0	BS 5136-0	Nickel plated brass, accepts 4-5 mm cable diameter, IDC, accepts 22-26 AWG conductors, 85 °C, 32 V, 4 A, mates with 3-pin threaded cordsets and receptacles	<p>Female</p> <p>Male</p>
<p>BS 513(4)6-0</p>	B 5146-0	BS 5146-0	Nickel plated brass, accepts 4-5 mm cable diameter, IDC, accepts 22-26 AWG conductors, 85 °C, 32 V, 4 A, mates with 4-pin threaded cordsets and receptacles	<p>Female</p> <p>Male</p>

We reserve the right to make technical alterations without prior notice.

M8 Picofast to M12 Eurofast® Adapters

- Enables Picofast and Eurofast Connectors to be interchanged
- Eurofast Connection has Anti-vibration Coupling Nut
- IEC IP67 Protection



Housing Style	Part Number	Features	Wiring Diagram
<p>FKMR 4 ..</p>	FKMR 4-ESM 3S	TPU body, 60 VAC/75 VDC, 4 A, 80 °C, female Eurofast, male snap-lock Picofast connector, 3-pin	
	FKMR 4.4-ESM 4S	TPU body, 30 VAC/36 VDC, 4 A, 80 °C, female Eurofast, male snap-lock Picofast connector, 4-pin	
<p>FSMR 4 ..</p>	FSMR 4-SKM 3	TPU body, 60 VAC/75 VDC, 4 A, 80 °C, male Eurofast, female threaded Picofast connector, 3-pin	
	FSMR 4.4-SKM 4	TPU body, 30 VAC/36 VDC, 4 A, 80 °C, male Eurofast, female threaded Picofast connector, 4-pin	

Add "/S857" to the end of part description to specify addition of mounting hole.

We reserve the right to make technical alterations without prior notice.

Field Wireables

Pinouts

3-Pin Picofast	4-Pin Picofast	4-Pin Eurofast	3-Pin Picofast	4-Pin Picofast	4-Pin Eurofast
Female			Male		

Connector Inserts

- For use in Sensors and Custom Receptacles
- Clear Body versions for use with Indicator LEDs
- Solder Lug or Printed Circuit Pin mounting options



Housing Style	Female Part Number	Features	Pinout
	ESM 3S (10/BAG)	Nylon, black, solder cup, accepts 26 AWG, 60 VAC/75 VDC, 4 A, 80 °C, 3-pin snap lock	Male
	ESM 4S (10/BAG)	Nylon, black, solder cup, accepts 28 AWG, 30 VAC/36 VDC, 4 A, 80 °C, 4-pin snap lock	Male
	ESM 6S (10/BAG)	Nylon, black, solder cup, accepts 26 AWG, 24 VDC, 1 A, 80 °C, 6-pin snap lock	Male
	ESHM 3L (10/BAG)	Nickel plated brass and nylon housing, solder cup, accepts 26 AWG, 30 VAC/75 VDC, 4 A, 80 °C, 3-pin snap lock clear body for LED	Male
	ESHM 4L (10/BAG)	Nickel plated brass and nylon housing, solder cup, accepts 26 AWG, 30 VAC/36 VDC, 4 A, 80 °C, 4-pin snap lock clear body for LED	Male
	ESHM 3P (10/BAG)	Nickel plated brass and nylon housing, PCB pin, 60 VAC/75 VDC, 4 A, 80 °C, 3-pin snap lock clear body for LED	Male
	ESHM 4P (10/BAG)	Nickel plated brass and nylon housing, PCB pin, 30 VAC/36 VDC, 4 A, 80 °C, 4-pin snap lock clear body for LED	Male

We reserve the right to make technical alterations without prior notice.

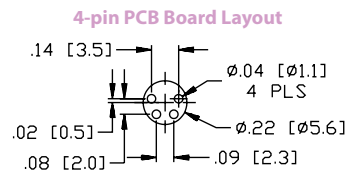
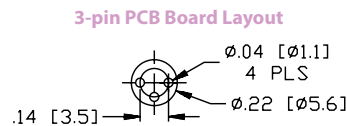
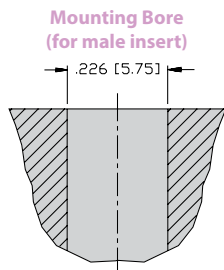

Connector Inserts

- For use in Sensors and Custom Receptacles
- Clear Body versions for use with Indicator LEDs
- Solder Lug or Printed Circuit Pin mounting options



Housing Style	Male Part Number	Features	Pinout
<p>SESM ..</p> <p>Dimensions: $\phi .216$ [5.5], .476 [12.1], .346 [8.8], $\phi .335$ [8.5], $\phi .274$ [6.95] M8x1, .069 [1.75], .228 [5.8]</p> <p>ESGM ..</p> <p>Dimensions: .650 [16.5], .551 [14.0], .354 [9.0], $\phi .228$ [5.8], $\phi .274$ [6.95]</p>	SESM 3S (10/BAG)	Nickel plated brass and nylon housing, solder cup, accepts 26 AWG, 60 VAC/75 VDC, 4 A, 80 °C, 3-pin snap lock or threaded	<p>Male</p>
	SESM 4S (10/BAG)	Nickel plated brass and nylon housing, solder cup, accepts 28 AWG, 30 VAC/36 VDC, 4 A, 80 °C, 4-pin snap lock or threaded	<p>Male</p>
	ESGM 3L (10/BAG)	Nickel plated brass housing with clear nylon lens, solder cup, accepts 26 AWG, 60 VAC/75 VDC, 4 A, 80 °C, 3-pin snap lock or threaded, clear lens for LED	<p>Male</p>
	ESGM 4L (10/BAG)	Nickel plated brass housing with clear nylon lens, solder cup, accepts 26 AWG, 30 VAC/36 VDC, 4 A, 80 °C, 4-pin snap lock or threaded, clear lens for LED	<p>Male</p>
	ESGM 3P (10/BAG)	Nickel plated brass housing with clear nylon lens, PCB pin, 60 VAC/75 VDC, 4 A, 80 °C, 3-pin snap lock or threaded, clear lens for LED	<p>Male</p>
	ESGM 4P (10/BAG)	Nickel plated brass housing with clear nylon lens, PCB pin, 30 VAC/36 VDC, 4 A, 80 °C, 4-pin snap lock or threaded, clear lens for LED	<p>Male</p>

We reserve the right to make technical alterations without prior notice.

Accessories

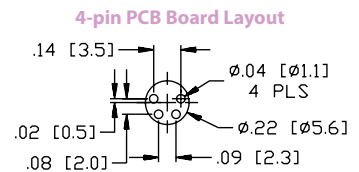
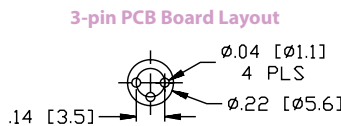
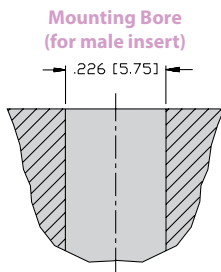

Connector Inserts

- For use in Sensors and Custom Receptacles
- Clear Body versions for use with Indicator LEDs
- Female Inserts
- Solder Lug or Printed Circuit Pin mounting options

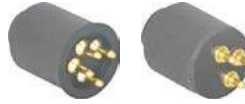

Housing Style	Female Part Number	Features	Pinout
<p>MFK ..</p> <p>.547 [13.91] .455 [11.51] .335 [8.51] ø.224 [5.71] ø.327 [8.31]</p> <p>MFKB ..</p> <p>ø.220 [5.61] ø.327 [8.31] .378 [9.61] .071 [1.81] .547 [13.91]</p>	MFK 3 (10/BAG)	TPU housing, black, PCB pins, 60 VAC/75 VDC, 4 A, 80 °C, 3-pin snap lock	<p>Female</p>
	MFK 4 (10/BAG)	TPU housing, black, PCB pins, 30 VAC/36 VDC, 4 A, 80 °C, 4-pin snap lock	
	MFKB 3 (10/BAG)	TPU housing, black, PCB pins, 60 VAC/75 VDC, 4 A, 80 °C, 3-pin snap lock	<p>Female</p>
	MFKB 4 (10/BAG)	TPU housing, black, PCB pins, 30 VAC/36 VDC, 4 A, 80 °C, 4-pin snap lock	
	MFKB 3L (10/BAG)	TPU housing, black, solder cups, 60 VAC/75 VDC 4 A, 80 °C, 3-pin snap lock, accepts 24 AWG	
	MFKB 4L (10/BAG)	TPU housing, black, solder cups, 30 VAC/36 VDC 4 A, 80 °C, 4-pin snap lock, accepts 24 AWG	

We reserve the right to make technical alterations without prior notice.

3-pin PCB Board Layout

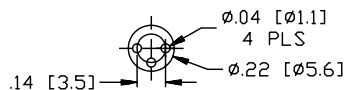

4-pin PCB Board Layout

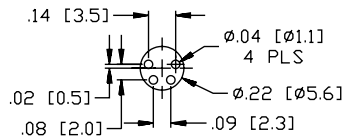

Closure Caps

- For use with Cordsets, Receptacles and Junction Boxes



We reserve the right to make technical alterations without prior notice.

Housing Style	Part Number	Features
	PSGK-MC (8/BAG)	Nylon, Mates to female snap lock cordsets, receptacles and junction boxes
	PSGM-CC (8/BAG)	Nylon, Mates to female threaded cordsets, receptacles and junction boxes
	PSG-CC	Nickel plated brass, Mates to female threaded cordsets, receptacles and junction boxes
	PSG-MC	Nickel plated brass, Mates to female threaded cordsets, receptacles and junction boxes
	PKG-CC	Nickel plated brass, Mates to male threaded cordsets, receptacles and junction boxes
	PKG-MC	Nickel plated brass, Mates to male threaded cordsets, receptacles and junction boxes

Accessories

M8 Picofast "Snap Lock" Connector Instructions

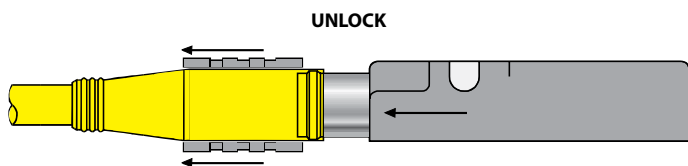

With Turck's patented Locking Sleeve pulled back, any Picofast sensor slides on without any difficulty.

After sensor is connected, push Locking Sleeve forward to create a watertight connection. It's a snap!

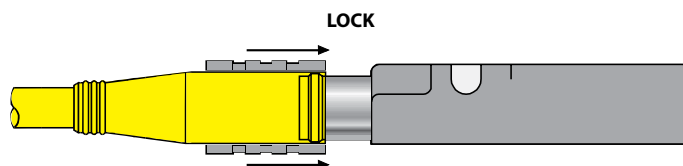

Installation Instructions

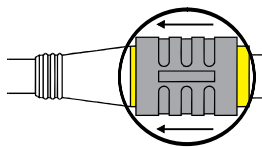
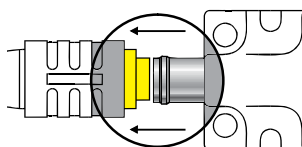
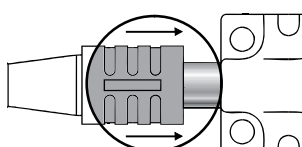
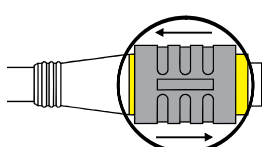
To Attach:
<p>1. Be sure black locking sleeve is pulled back.</p> 
<p>2. Line up pins and push connector onto plug. You will feel a "snap." Do not twist.</p> 
<p>3. Push locking sleeve forward on connector until it is flush with the front of the connector.</p> 
<p>4. If sleeve is difficult to slide on a new connector, "exercise" it a few times. Do not use tools.</p> 

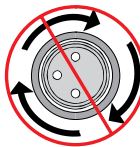
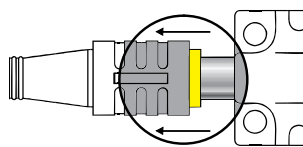
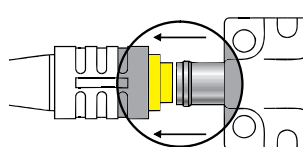
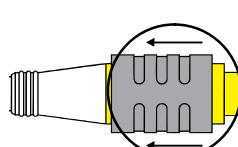
To Detach:
<p>1. Do not twist.</p> 
<p>2. Pull locking sleeve back to "unlocked" position.</p> 
<p>3. Pull connector straight off.</p> 
<p>4. Leave locking sleeve in unlocked position.</p> 

Part Number Keys	D2
Cordsets	D7
Receptacles	D45
Field Wireables	D83
Adapters	D91
Inserts	D94
Closure Caps	D95

Features

- 4-12 pins utilizing 2-12 wires
- Nickel-brass, stainless steel and nylon materials
- Fully shielded options
- Multiple connector mold bodies
- Quick-connect selection
- LED options
- Multiple receptacle mounting thread options
- Receptacles with leads, solder cups or PCB pins



Cordset Part Number key

Part Number Keys are to assist in IDENTIFICATION ONLY. Consult factory for catalog items not identified.

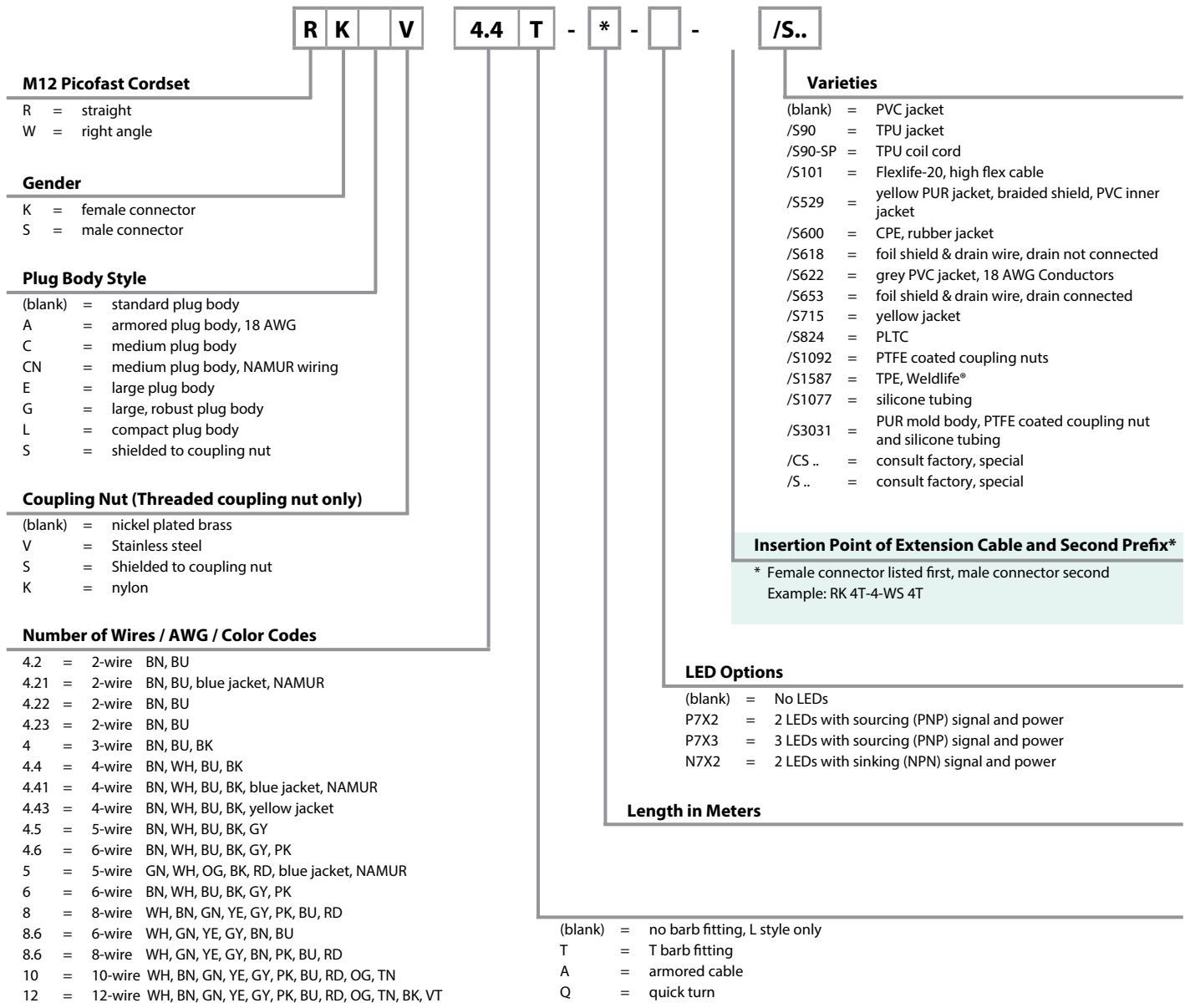

Cordset Part Number key

Extension Examples:

Hybrid connector extensions also available. Consult factory.

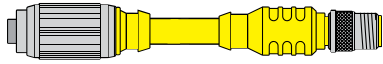

R K G 4.4 T - 2 - R S E 4.4 T /S600



R K 4.4 T - 2 - R S 4.4 T

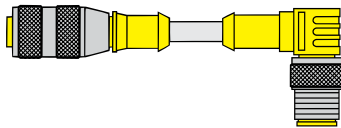

R K 4.4 T - 2 - W S 4.4 T

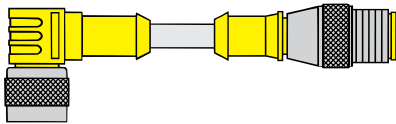

W K 4.4 T - 2 - R S 4.4 T

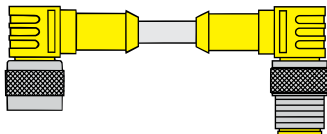

W K 4.4 T - 2 - W S 4.4 T

Reverse Key (B-Code) Cordset Part Number Key

Part Number Keys are to assist in IDENTIFICATION ONLY. Consult factory for catalog items not identified.

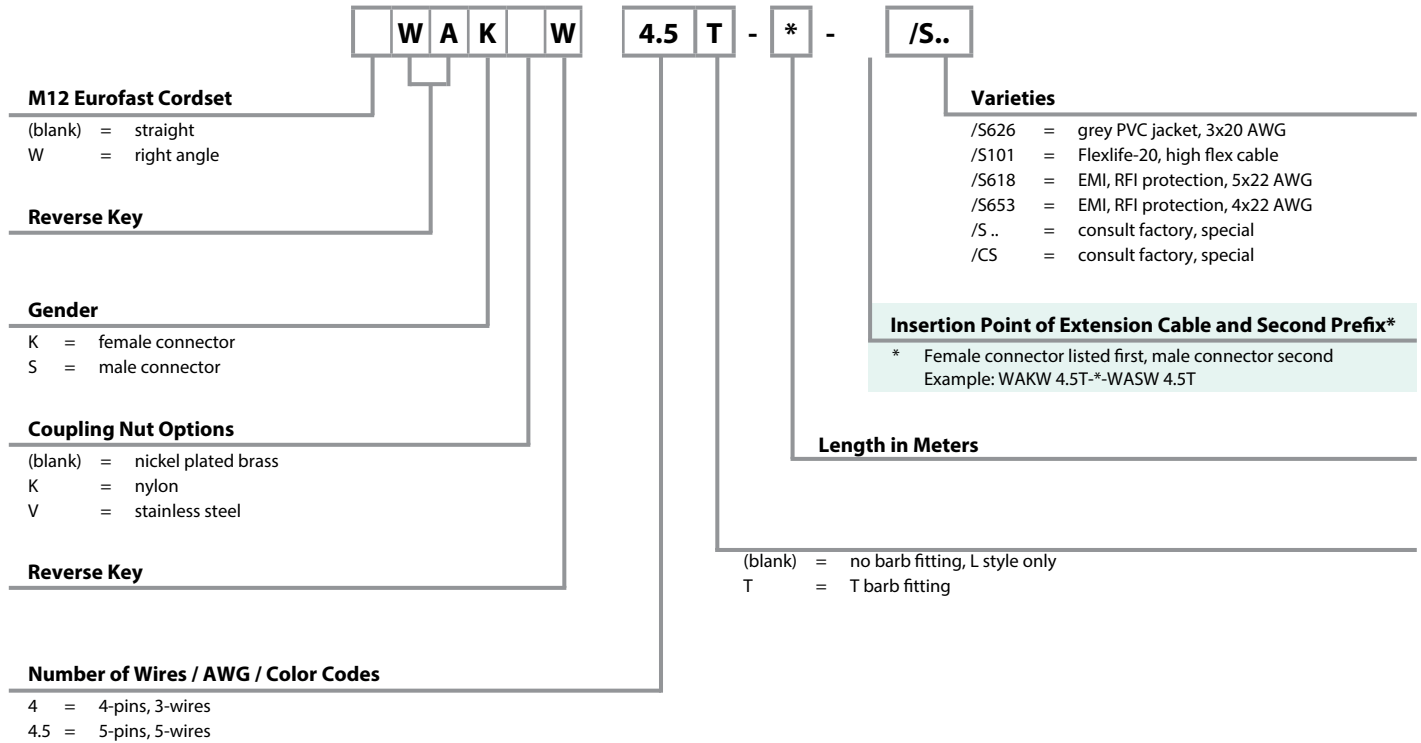

AWG sizes depend on body styles and "/S" variety

Receptacle Part Number Key

Part Number Keys are to assist in IDENTIFICATION ONLY. Consult factory for catalog items not identified.

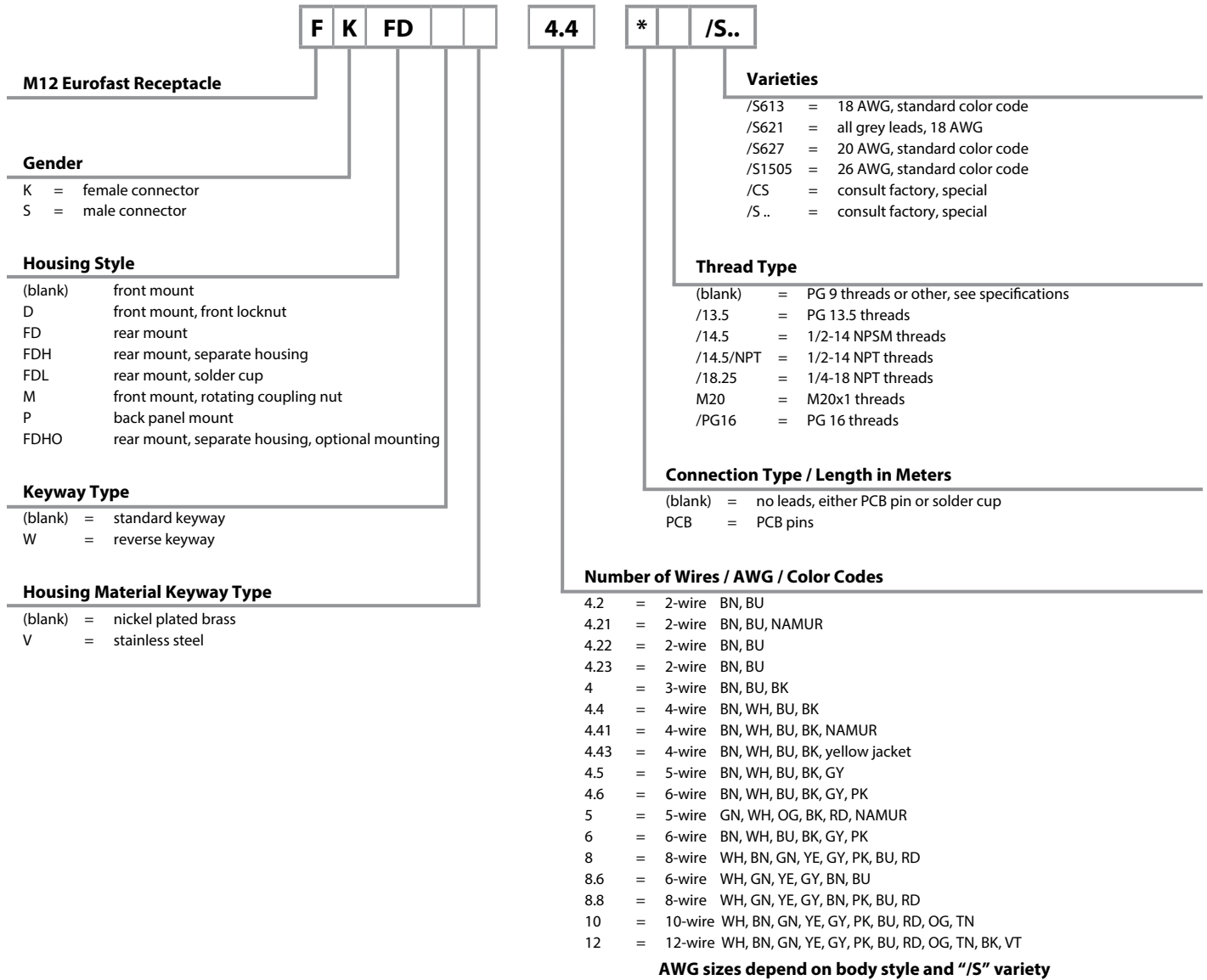

Field Wireable Part Number Key

Part Number Keys are to assist in IDENTIFICATION ONLY. Consult factory for catalog items not identified.

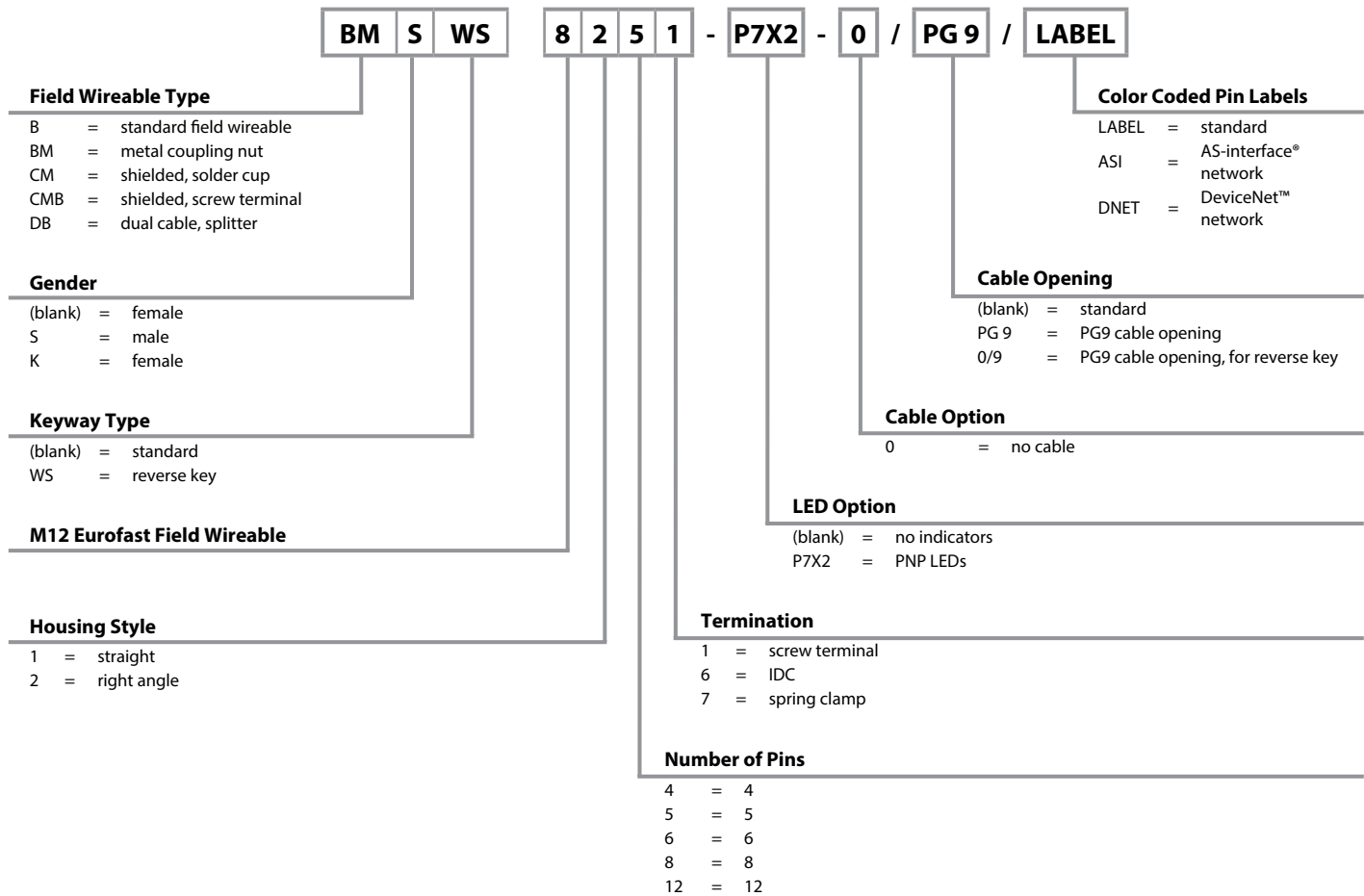

2-Wire Cordsets, Standard Plug Body

- NEMA 1, 3, 4, 6P
- IEC IP68 Protection
- 250 V, 4 A



We reserve the right to make technical alterations without prior notice.

Connector Style	Female Part Number	Male Part Number	Features	Pinout
<p>RK ..**</p>	RK 4.2T-* WK 4.2T-*	RS 4.2T-* WS 4.2T-*	ITC/PLTC PVC Grey, 2x20 AWG, 105 °C, 5.1 mm OD, Cable #RF50529-*M, Flexlife®	1. N/C 2. N/C 3. BN 4. BU
	RK 4.2T-*/S90 WK 4.2T-*/S90	RS 4.2T-*/S90 WS 4.2T-*/S90	AWM TPU Grey, 2x20 AWG, 90 °C, 4.8 mm OD, Cable #RF50772-*M, Cut/Abrasion Immune	1. WH 2. N/C 3. N/C 4. BK
<p>WK ..**</p>	RK 4.2T-*/S748 WK 4.2T-*/S748	RS 4.2T-*/S748 WS 4.2T-*/S748	ITC/PLTC PVC Yellow, 2x22 AWG, 105 °C, 5.1 mm OD, Cable #RF50650-*M, Flexlife	<p>Female</p>
	RK 4.21T-*/S1511 WK 4.21T-*/S1511	RS 4.21T-*/S1511 WS 4.21T-*/S1511	ITC/PLTC PVC Grey, 2x20 AWM PVC, 105 °C, 5.1 mm OD, Cable #RF50529-*M, Flexlife	
<p>RS ..**</p>	RK 4.21T-* WK 4.21T-*	RS 4.21T-* WS 4.21T-*	ITC/PLTC PVC NAMUR Blue, 2x20 AWG, 105 °C, 5.1 mm OD, Cable #RF51923-*M	1. BN 2. BU 3. N/C 4. N/C
	RK 4.21T-*/S90 WK 4.21T-*/S90	RS 4.21T-*/S90 WS 4.21T-*/S90	AWM TPU NAMUR Blue, 2x20 AWG, 90 °C, 5.1 mm OD, Cable #RF50657-*M, Cut/Abrasion Immune	<p>Male</p>
<p>WS ..**</p>	RK 4.22T-* WK 4.22T-*	RS 4.22T-* WS 4.22T-*	ITC/PLTC PVC Grey, 2x20 AWG, 105 °C, 5.1 mm OD, Cable #RF50529-*M, Flexlife	
	RK 4.23T-* WK 4.23T-*	RS 4.23T-* WS 4.23T-*		1. BN 2. N/C 3. N/C 4. BU

* Length in meters. Standard cable lengths are 2, 4, 5, 6, 8 and 10 meters. Consult factory for other lengths.

** Standard coupling nut material is nickel plated brass "RK .."; "RKK .." indicates nylon and "RKV .." indicates stainless steel.

Cordsets

- NEMA 1, 3, 4, 6P
- IEC IP68 Protection
- 250 V, 4 A



Connector Style	Female Part Number	Male Part Number	Features	Pinout
<p>RK ..**</p>	RK 4T-* WK 4T-*	RS 4T-* WS 4T-*	ITC/PLTC PVC Grey, 3x20 AWG, 105 °C, 5.1 mm OD, Cable #RF52081-*M, Flexlife®	<p>Female</p> <p>Male</p>
	RK 4T-*/S90 WK 4T-*/S90	RS 4T-*/S90 WS 4T-*/S90	AWM TPU Grey, 3x22 AWG, 90 °C, 4.8 mm OD, Cable #RF52080-*M, Cut/Abrasion Immune	
<p>WK ..**</p>	RK 4T-*/S101 WK 4T-*/S101	RS 4T-*/S101 WS 4T-*/S101	AWM TPE Grey, 3x22 AWG, 105 °C, 4.8 mm OD, Cable #RF52085-*M, Flexlife-20, High Flex Over 20 Million Cycles	
	RK 4T-*/S529 WK 4T-*/S529	RS 4T-*/S529 WS 4T-*/S529	TPU/Heavy Braid Double Jacket Yellow, 3x22 AWG, 90 °C, 4.8 mm OD, Cable #RF52084-*M, Cut/Abrasion Immune Braided Mechanical Shield	
<p>RS ..**</p>	RK 4T-*/S824 WK 4T-*/S824	RS 4T-*/S824 WS 4T-*/S824	ITC/PLTC AWM PVC Grey, 3x22 AWG, 105 °C, 5.1 mm OD, Cable #RF52081-*M, Tray Rated, Flexlife	
	RK 4T-*/S715 WK 4T-*/S715	RS 4T-*/S715 WS 4T-*/S715	ITC/PLTC PVC Yellow, 3x22 AWG, 105 °C, 5.1 mm OD, Cable #RF52087-*M, Flexlife	
<p>WS ..**</p>	RK 4T-*/S760 WK 4T-*/S760	RS 4T-*/S760 WS 4T-*/S760	ITC/PLTC PVC Black, 3x22 AWG, 105 °C, 5.1 mm OD, Cable #RF52083-*M, Flexlife	
	RK 4T-*/S618 WK 4T-*/S618	RS 4T-*/S618 WS 4T-*/S618	ITC/PLTC PVC Grey, 3x22 AWG, Foil/Drain, 105 °C, 5.1 mm OD, Cable #RF52082-*M, RFI/EMI Shielding, tray rated	

We reserve the right to make technical alterations without prior notice.

* Length in meters. Standard cable lengths are 2, 4, 5, 6, 8 and 10 meters. Consult factory for other lengths.

** Standard coupling nut material is nickel plated brass "RK .."; "RKK .." indicates nylon and "RKV .." indicates stainless steel.

4-Wire Cordsets, Standard Plug Body

- NEMA 1, 3, 4, 6P
- IEC IP68 Protection
- 250 V, 4 A



We reserve the right to make technical alterations without prior notice.

Connector Style	Female Part Number	Male Part Number	Features	Pinout
<p>RK ..**</p> <p>WK ..**</p> <p>RS ..**</p> <p>WS ..**</p>	RK 4.41T-* WK 4.41T-*	RS 4.41T-* WS 4.41T-*	ITC/PLTC PVC NAMUR Blue, 4x22 AWG, 105 °C, 5.3 mm OD, Cable #RF50598-*M, Flexlife®	<p>Female</p> <p>1. BN 2. WH 3. BU 4. BK</p> <p>Male</p>
	RK 4.41T-*/S529 WK 4.41T-*/S529	RS 4.41T-*/S529 WS 4.41T-*/S529	TPU/Heavy Braid Double Jacket Yellow, 4x20 AWG, 90 °C, 5.7 mm OD, Cable #RF50526-*M, Cut/Abrasion Immune Braided Mechanical Shield	
	RK 4.43T-* WK 4.43T-*	RS 4.43T-* WS 4.43T-*	ITC/PLTC PVC Yellow, 4x22 AWG, 105 °C, 5.3 mm OD, Cable #RF50530-*M, Flexlife	
	RK 4.43T-*/S90 WK 4.43T-*/S90	RS 4.43T-*/S90 WS 4.43T-*/S90	AWM TPU Yellow, 4x22 AWG, 90 °C, 5.1 mm OD, Cable #RF50613-*M, Cut/Abrasion Immune	
	RK 4.4T-* WK 4.4T-*	RS 4.4T-* WS 4.4T-*	ITC/PLTC PVC Grey, 4x22 AWG, 105 °C, 5.3 mm OD, Cable #RF50516-*M, Flexlife	
	RK 4.4T-*/S90 WK 4.4T-*/S90	RS 4.4T-*/S90 WS 4.4T-*/S90	AWM TPU Grey, 4x22 AWG, 90 °C, 5.1 mm OD, Cable #RF50532-*M, Cut/Abrasion Immune	
	RK 4.4T-*/S101 WK 4.4T-*/S101	RS 4.4T-*/S101 WS 4.4T-*/S101	AWM TPE Grey, 4x22 AWG, 105 °C, 5.1 mm OD, Cable #RF50941-*M, Flexlife-20, High Flex Over 20 Million Cycles	
	RK 4.4T-*/S824 WK 4.4T-*/S824	RS 4.4T-*/S824 WS 4.4T-*/S824	ITC/PLTC PVC Grey, 4x22 AWG, 105 °C, 5.3 mm OD, Cable #RF50698-*M, Tray Rated	
	RK 4.4T-*/S618 WK 4.4T-*/S618	RS 4.4T-*/S618 WS 4.4T-*/S618	ITC/PLTC PVC Grey, 4x22 AWG Foil/Drain, 105 °C, 5.3 mm OD, Cable #RF50577-*M, RFI/EMI Shielding	
RK 4.4T-*/S618/S824 WK 4.4T-*/S618/S824	RS 4.4T-*/S618/S824 WS 4.4T-*/S618/S824	ITC/PLTC PVC Grey, 4x22 AWG Foil/Drain, 105 °C, 5.3 mm OD, Cable #RF50777-*M, RFI/EMI Shielding, Tray Rated		

* Length in meters. Standard cable lengths are 2, 4, 5, 6, 8 and 10 meters. Consult factory for other lengths.

** Standard coupling nut material is nickel plated brass "RK .."; "RKK .." indicates nylon and "RKV .." indicates stainless steel.

- NEMA 1, 3, 4, 6P
- IEC IP68 Protection
- 250 V, 4 A



Connector Style	Female Part Number	Male Part Number	Features	Pinout
<p>RK ..**</p>	<p>RK 4.4T-*/S653 WK 4.4T-*/S653</p>	<p>RS 4.4T-*/S653 WS 4.4T-*/S653</p>	<p>ITC/PLTC PVC Grey, 3x22 AWG Foil/Drain, 105 °C, 5.1 mm OD, Cable #RF52082-*M, RFI/EMI Shielding, Tray Rated</p>	<p>1. BN 2. Drain 3. BU 4. BK</p>
<p>WK ..**</p>	<p>RK 4.4T-*/S760 WK 4.4T-*/S760</p>	<p>RS 4.4T-*/S760 WS 4.4T-*/S760</p>	<p>ITC/PLTC PVC Black, 4x22 AWG, 105 °C, 5.3 mm OD, Cable #RF50983-*M, Flexlife®</p>	<p>Female</p>
<p>RS ..**</p>	<p>RK 4.4T-*/S90/S670 WK 4.4T-*/S90/S670</p>	<p>RS 4.4T-*/S90/S670 WS 4.4T-*/S90/S670</p>	<p>AWM TPU Black, 4x26 AWG, 90 °C, 4.2 mm OD, Cable #RF50586-*M, Cut/Abrasion Immune</p>	
<p>RS ..**</p>	<p>RK 4.4T-*/S1587 WK 4.4T-*/S1587</p>	<p>RS 4.4T-*/S1587 WS 4.4T-*/S1587</p>	<p>ITC/PLTC TPE Yellow, 4x22 AWG, 105 °C, 5.3 mm OD, Cable #RF51132-*M, Weldlife, Weld Flash Immune</p>	<p>1. BN 2. WH 3. BU 4. BK</p>
<p>WS ..**</p>	<p>RK 4.4T-*/S1666 WK 4.4T-*/S1666</p>	<p>RS 4.4T-*/S1666 WS 4.4T-*/S1666</p>	<p>AWM TPU Grey, 2: 2x22 AWG, STP Foil/Drain, 90 °C, 6.2 mm OD, Cable #RF51069-*M, Cut/Abrasion Immune, Shielded Twisted Pair for Communication</p>	<p>Male</p>

We reserve the right to make technical alterations without prior notice.

* Length in meters. Standard cable lengths are 2, 4, 5, 6, 8 and 10 meters. Consult factory for other lengths.

** Standard coupling nut material is nickel plated brass "RK .."; "RKK .." indicates nylon and "RKV .." indicates stainless steel.

5-Wire Cordsets, Standard Plug Body

- NEMA 1, 3, 4, 6P
- IEC IP68 Protection
- 250 V, 4 A



Connector Style	Female Part Number	Male Part Number	Features	Pinout
<p>RK ..**</p>	RK 4.5T-* WK 4.5T-*	RS 4.5T-* WS 4.5T-*	ITC/PLTC PVC Grey, 5x22 AWG, 105 °C, 5.7 mm OD, Cable #RF50543-*M, Flexlife®	
	RK 4.5T-*/S90 WK 4.5T-*/S90	RS 4.5T-*/S90 WS 4.5T-*/S90	AWM TPU Grey, 5x22 AWG, 90 °C, 5.3 mm OD, Cable #RF50649-*M, Cut/Abrasion Immune	
<p>WK ..**</p>	RK 4.5T-*/S101 WK 4.5T-*/S101	RS 4.5T-*/S101 WS 4.5T-*/S101	AWM TPE Grey, 5x22 AWG, 105 °C, 5.1 mm OD, Cable #RF50909-*M, Flexlife-20, High Flex Over 20 Million Cycles	
	RK 4.5T-*/S618 WK 4.5T-*/S618	RS 4.5T-*/S618 WS 4.5T-*/S618	ITC/PLTC PVC Grey, 5x22 AWG Foil/Drain, 105 °C, 5.7 mm OD, Cable #RF50609-*M, RFI/EMI Protection	
<p>RS ..**</p>	RS 4.5T-*/S715 WS 4.5T-*/S715	RS 4.5T-*/S715 WS 4.5T-*/S715	ITC/PLTC PVC Yellow, 5x22 AWG, 105 °C, 5.7 mm OD, Cable #RF50684-*M, Flexlife	
	RK 4.5T-*/S653 WK 4.5T-*/S653	RS 4.5T-*/S653 WS 4.5T-*/S653	ITC/PLTC PVC Grey, 4x22 AWG Foil/Drain, 105 °C, 5.3 mm OD, Cable #RF50577-*M, RFI/EMI Shielding	
<p>WS ..**</p>	RK 4.5T-*/S1554 WK 4.5T-*/S1554	RS 4.5T-*/S1554 WS 4.5T-*/S1554	ITC/PLTC PVC Black, 5x22 AWG Foil/Drain, 105 °C, 5.7 mm OD, Cable #RF50794-*M, RFI/EMI Shielding	

We reserve the right to make technical alterations without prior notice.

Cordsets

* Length in meters. Standard cable lengths are 2, 4, 5, 6, 8 and 10 meters. Consult factory for other lengths.

** Standard coupling nut material is nickel plated brass "RK .."; "RKK .." indicates nylon and "RKV .." indicates stainless steel.

6-Wire Cordsets, Standard Plug Body

- NEMA 1, 3, 4, 6P
- IEC IP68 Protection
- 250 V, 4 A



Connector Style	Female Part Number	Male Part Number	Features	Pinout
<p>RK..**</p>	<p>RK 4.6T-* WK 4.6T-*</p>	<p>RS 4.6T-* WS 4.6T-*</p>	<p>AWM PVC Grey, 6x24 AWG, 105 °C, 5.1 mm OD, Cable #RF50608-*M, Flexlife®</p>	<p>Female</p> <p>1. BN 2. WH 3. BU 4. BK 5. GY 6. PK</p> <p>Male</p> <p>1. BN 2. WH 3. BU 4. BK 5. GY 6. Drain</p>
<p>WK..**</p>	<p>RK 4.6T-*/S90 WK 4.6T-*/S90</p>	<p>RS 4.6T-*/S90 WS 4.6T-*/S90</p>	<p>AWM TPU Grey, 6x24 AWG, 90 °C, 5.1 mm OD, Cable #RF50646-*M, Cut/ Abrasion Immune</p>	
<p>RS..**</p>	<p>RK 4.6T-*/S90/S760 WK 4.6T-*/S90/S760</p>	<p>RS 4.6T-*/S90/S760 WS 4.6T-*/S90/S760</p>	<p>AWM TPU Black, 6x24 AWG, 90 °C, 5.1 mm OD, Cable #RF50728-*M, Cut/ Abrasion Immune</p>	
<p>WS..**</p>	<p>RK 4.6T-*/S618 WK 4.6T-*/S618</p>	<p>RS 4.6T-*/S618 WS 4.6T-*/S618</p>	<p>AWM PVC Grey, 6x24 AWG Foil/Drain, 105 °C, 5.1 mm OD, Cable #RF50610-*M, RFI/EMI Shielding</p>	
	<p>RK 4.6T-*/S653 WK 4.6T-*/S653</p>	<p>RS 4.6T-*/S653 WS 4.6T-*/S653</p>	<p>ITC/PLTC PVC Grey, 5x22 AWG Foil/Drain, 105 °C, 5.7 mm OD, Cable #RF50609-*M, RFI/EMI Shielding</p>	

We reserve the right to make technical alterations without prior notice.

* Length in meters. Standard cable lengths are 2, 4, 6, 8 and 10 meters. Consult factory for other lengths.

** Standard coupling nut material is nickel plated brass "RK.."; "RKK.." indicates nylon and "RKV.." indicates stainless steel.

10 and 12-Wire Cordsets, Standard Plug Body

- NEMA 1, 3, 4, 6P
- IEC IP68 Protection
- 60 VAC/75 VDC, 2 A



Connector Style	Female Part Number	Male Part Number	Features	Pinout
<p>RK ..**</p>	RK 10T-*	RS 10T-*	AWM PVC Grey, 10x24 AWG, 105 °C, 6.2 mm OD, Cable #RF51004-*M, Flexlife®	<ol style="list-style-type: none"> WH BN GN YE GY
	RK 10T-*/S90	RS 10T-*/S90	AWM TPU Grey, 10x24 AWG, 90 °C, 6.2 mm OD, Cable #RF51005-*M, Cut/Abrasion Immune	<ol style="list-style-type: none"> PK BU RD OG TN
<p>RS ..**</p>	RK 12T-*	RS 12T-*	AWM PVC Grey, 12x24 AWG, 105 °C, 6.3 mm OD, Cable #RF50991-*M, Flexlife	<ol style="list-style-type: none"> WH BN GN YE GY PK BU RD OG TN BK VT
	RK 12T-*/S90	RS 12T-*/S90	AWM TPU Grey, 12x24 AWG, 90 °C, 6 mm OD, Cable #RF50990-*M, Cut/Abrasion Immune	

We reserve the right to make technical alterations without prior notice.

Cordsets

* Length in meters. Standard cable lengths are 2, 4, 6, 8 and 10 meters. Consult factory for other lengths.

** Standard coupling nut material is nickel plated brass "RK .."; "RKK .." indicates nylon and "RKV .." indicates stainless steel.

2 and 3-Wire Cordsets, "C" Style Medium Plug Body

- NEMA 1, 3, 4, 6P
- IEC IP68 Protection
- 250 V, 4 A



Connector Style	Female Part Number	Male Part Number	Features	Pinout
<p>RKC ..**</p>	RKC 4.2T-* WKC 4.2T-*	RSC 4.2T-* WSC 4.2T-*	ITC/PLTC PVC Yellow, 2x18 AWG, 105 °C, 6.2 mm OD, Cable #RF50511-*M, Flexlife®	<p>Female</p> <p>1. N/C 2. N/C 3. BN 4. BU</p>
<p>WKC ..**</p>	RKC 4.2T-*/CS10191 WKC 4.2T-*/CS10191	RSC 4.2T-*/CS10191 WSC 4.2T-*/CS10191	ITC/PLTC PVC NAMUR Blue, 2x18 AWG, 105 °C, 6.2 mm OD, Cable #RF50843-*M, Flexlife, Black Plug Body	
<p>RSC ..**</p>				<p>Male</p> <p>1. BN 2. N/C 3. BU 4. BK</p>
<p>WSC ..**</p>	RKC 4T-* WKC 4T-*	RSC 4T-* WSC 4T-*	ITC/PLTC PVC Yellow, 3x18 AWG, 105 °C, 6.2 mm OD, Cable #RF50513-*M, Flexlife	

We reserve the right to make technical alterations without prior notice.

* Length in meters. Standard cable lengths are 2, 4, 6, 8 and 10 meters. Consult factory for other lengths.

** Standard coupling nut material is nickel plated brass "RKC .."; "RKC V .." indicates stainless steel.

4-Wire Cordsets, "C" Style Medium Plug Body

- NEMA 1, 3, 4, 6P
- IEC IP68 Protection
- 250 V, 4 A



Connector Style	Female Part Number	Male Part Number	Features	Pinout
<p>RKC ..**</p>	RKC 4.4T-* WKC 4.4T-*	RSC 4.4T-* WSC 4.4T-*	ITC/PLTC PVC Yellow, 4x18 AWG, 105 °C, 6.7 mm OD, Cable #RF50579-*M, Flexlife®	<p>Female</p>
	RKC 4.4T-*/S90 WKC 4.4T-*/S90	RSC 4.4T-*/S90 WSC 4.4T-*/S90	AWM TPU Yellow, 4x18 AWG, 90 °C, 7.2 mm OD, Cable #RF50544-*M, Cut/Abrasion Immune	
<p>WKC ..**</p>	RKC 4.4T-*/S622 WKC 4.4T-*/S622	RSC 4.4T-*/S622 WSC 4.4T-*/S622	ITC/PLTC PVC Grey, 4x18 AWG, 105 °C, 6.7 mm OD, Cable #RF50580-*M, Flexlife	
	RKC 4.4T-*/S824 WKC 4.4T-*/S824	RSC 4.4T-*/S824 WSC 4.4T-*/S824	ITC/PLTC PVC Grey, 4x18 AWG, 105 °C, 6.7 mm OD, Cable #RF50579-*M, Tray Rated, Flexlife	
<p>RSC ..**</p>	RKC 4.4T-*/S1587 WKC 4.4T-*/S1587	RSC 4.4T-*/S1587 WSC 4.4T-*/S1587	ITC/PLTC TPE Yellow, 4x18 AWG, 105 °C, 6.9 mm OD, Cable #RF50956-*M, Weld Flash Immune, Weldlife	
	RKC 4.4T-*/S101/S849 WKC 4.4T-*/S101/S849	RSC 4.4T-*/S101/S849 WSC 4.4T-*/S101/S849	AWM TPE Grey, 4x22 AWG, 105 °C, 5.1 mm OD, Cable #RF50941-*M, Flexlife-20, High Flex Over 20 Million Cycles	
<p>WSC ..**</p>	RKC 4.4T-*/S101 WKC 4.4T-*/S101	RSC 4.4T-*/S101 WSC 4.4T-*/S101	AWM TPE Yellow, 4x18 AWG, 105 °C, 6.2 mm OD, Cable #RF50968-*M, Flexlife-20, High Flex Over 20 Million Cycles	

We reserve the right to make technical alterations without prior notice.

Cordsets

* Length in meters. Standard cable lengths are 2, 4, 5, 6, 8 and 10 meters. Consult factory for other lengths.
 ** Standard coupling nut material is nickel plated brass "RKC .."; "RKC.V .." indicates stainless steel.

5-Wire Cordsets, "C" Style Medium Plug Body

- NEMA 1, 3, 4, 6P
- IEC IP68 Protection
- 250 V, 4 A

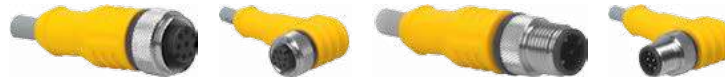

Connector Style	Female Part Number	Male Part Number	Features	Pinout
<p>RKC ..**</p>	<p>RKC 4.5T-*/S653 WKC 4.5T-*/S653</p>	<p>RSC 4.5T-*/S653 WSC 4.5T-*/S653</p>	ITC/PLTC PVC Grey, 4x22 AWG, 105 °C, Foil/ Drain, 5.3 mm OD, Cable #RF50577-*M, RFI/EMI Shielding, Tray Rated	<ol style="list-style-type: none"> 1. BN 2. WH 3. BU 4. BK 5. Drain
	<p>RKC 4.5T-*/S1538 WKC 4.5T-*/S1538</p>	<p>RSC 4.5T-*/S1538 WSC 4.5T-*/S1538</p>	ITC/PLTC PVC Grey, 5x18 AWG, 105 °C, 7.6 mm OD, Cable #RF50630-*M, Flexlife®	<ol style="list-style-type: none"> 1. BN 2. WH 3. BU 4. BK 5. GN/YE
<p>WKC ..**</p>	<p>RKC 4.5T-*/S715/S849 WKC 4.5T-*/S715/S849</p>	<p>RSC 4.5T-*/S715/S849 WSC 4.5T-*/S715/S849</p>	ITC/PLTC PVC Yellow, 5x22 AWG, 105 °C, 5.7 mm OD, Cable #RF50684-*M, Flexlife	<ol style="list-style-type: none"> 1. BN 2. WH 3. BU 4. BK 5. GY
	<p>RKC 4.5T-*/CS10288 WKC 4.5T-*/CS10288</p>	<p>RSC 4.5T-*/CS10288 WSC 4.5T-*/CS10288</p>	ITC/PLTC PVC Yellow, 5x18 AWG, 105 °C, 7.6 mm OD, Cable #RF50549-*M, Flexlife	<ol style="list-style-type: none"> 1. BN 2. WH 3. BU 4. BK 5. GN/YE
<p>RSC ..**</p>	<p>RKC 4.5T-*/S1587 WKC 4.5T-*/S1587</p>	<p>RSC 4.5T-*/S1587 WSC 4.5T-*/S1587</p>	ITC/PLTC TPE Yellow, 5x18 AWG, 105 °C, 7.6 mm OD, Cable #RF51720-*M, Weldlife, Weld Flash Immune	<ol style="list-style-type: none"> 1. BN 2. WH 3. BU 4. BK 5. GY
	<p>RKCN 5T-* WKCN 5T-*</p>	<p>RSCN 5T-* WSCN 5T-*</p>	ITC/PLTC PVC NAMUR Blue, 5x22 AWG, 105 °C, 6.2 mm OD, Cable #RF50767-*M, Flexlife, for VBN 40-H1141 Multibox®	<ol style="list-style-type: none"> 1. GN 2. WH 3. OG 4. BK 5. RD

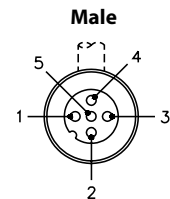
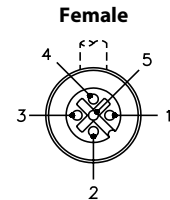

We reserve the right to make technical alterations without prior notice.

* Length in meters. Standard cable lengths are 2, 4, 6, 8 and 10 meters. Consult factory for other lengths.

** Standard coupling nut material is nickel plated brass "RKC .."; "RKC .." indicates stainless steel.

6-Wire Cordsets, "C" Style Medium Plug Body

- NEMA 1, 3, 4, 6P
- IEC IP68 Protection
- 60 VAC/75 VDC, 2 A

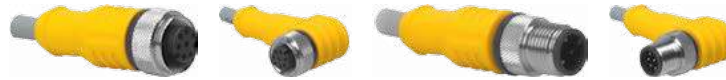

Connector Style	Female Part Number	Male Part Number	Features	Pinout
<p>RKC ..**</p> <p>1.654 [42.0] ϕ.589 [15.0]</p> <p>M12x1</p> <p>ANTI-VIBRATION DETENT</p> <p>WKC ..**</p> <p>1.736 [44.1] 1.122 [28.5]</p> <p>ϕ.532 [13.5]</p> <p>M12x1</p> <p>RSC ..**</p> <p>1.909 [48.5] .531 [13.5]</p> <p>M12x1</p> <p>WSC ..**</p> <p>1.736 [44.1] 1.377 [35.0]</p> <p>ϕ.531 [13.5]</p> <p>M12x1</p>	RKC 6T-* WKC 6T-*	RSC 6T-* WSC 6T-*	AWM PVC Grey, 6x24 AWG, 105 °C, 5.1 mm OD, Cable #RF50608-*M, Flexlife®	<p>Female</p> <p>1. BN 2. WH 3. BU 4. BK 5. GY 6. PK</p> <p>Male</p> <p>1. BN 2. WH 3. BU 4. BK 5. GY 6. Drain</p>
	RKC 6T-*/S90 WKC 6T-*/S90	RSC 6T-*/S90 WSC 6T-*/S90	AWM TPU Grey, 6x24 AWG, 90 °C, 5.1 mm OD, Cable #RF50646-*M, Cut/Abrasion Immune	
	RKC 6T-*/S101 WKC 6T-*/S101	RSC 6T-*/S101 WSC 6T-*/S101	AWM TPE Grey, 6x24 AWG, 105 °C, 5.1 mm OD, Cable #RF50910-*M, Flexlife-20, high flex over 20 million cycles	
	RKC 6T-*/S90/S760 WKC 6T-*/S90/S760	RSC 6T-*/S90/S760 WSC 6T-*/S90/S760	AWM TPU Black, 6x24 AWG, 90 °C, 5.1 mm OD, Cable #RF50728-*M, Cut/Abrasion Immune	
	RKC 6T-*/S529 WKC 6T-*/S529	RSC 6T-*/S529 WSC 6T-*/S529	AWM TPU Yellow, 6x24 AWG, 90 °C, 6.2 mm OD, Cable #RF51120-*M, Cut/Abrasion immune, braided mechanical shield	
	RKC 6T-*/S849/S1052 WKC 6T-*/S849/S1052	RSC 6T-*/S849/S1052 WSC 6T-*/S849/S1052	ITC/PLTC PVC Grey, 6x22 AWG, 105 °C, 6.2 mm OD, Cable #RF51284-*M, Flexlife, 22 AWG conductors, grey cable	
	RKC 6T-*/S618 WKC 6T-*/S618	RSC 6T-*/S618 WSC 6T-*/S618	AWM PVC Grey, 6x24 AWG Foil/Drain, 105 °C, 5.1 mm OD, Cable #RF50610-*M, RFI/EMI Shielding	
	RKC 6T-*/S653 WKC 6T-*/S653	RSC 6T-*/S653 WSC 6T-*/S653	ITC/PLTC PVC Grey, 5x22 AWG Foil/Drain, 105 °C, 5.7 mm OD, Cable #RF50609-*M, RFI/EMI Shielding	
	RKC 6T-*/S90/CS10476 WKC 6T-*/S90/CS10476	RSC 6T-*/S90/CS10476 WSC 6T-*/S90/CS10476	AWM TPU NAMUR Blue, 5x24 AWG Foil/Drain, 90 °C, 5.7 mm OD, Cable #RF50928-*M, Cut/Abrasion Immune	

* Length in meters. Standard cable lengths are 2, 4, 6, 8 and 10 meters. Consult factory for other lengths.

** Standard coupling nut material is nickel plated brass "RKC .."; "RKC .." indicates stainless steel.

We reserve the right to make technical alterations without prior notice.

Cordsets

- NEMA 1, 3, 4, 6P
- IEC IP68 Protection
- 60 VAC/75 VDC, 2 A

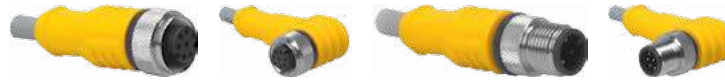

Connector Style	Female Part Number	Male Part Number	Features	Pinout
<p>RKC ..**</p>	RKC 8.6T-* WKC 8.6T-*	RSC 8.6T-* WSC 8.6T-*	AWM PVC Black, 6x24 AWG Foil/Drain, 105 °C, 5.1 mm OD, Cable #RF50845-*M, Flexlife®, for Picofast® 4-port Multibox®	1. WH 2. GN 3. YE 4. GY 5. BN 6. N/C 7. BU 8. N/C
	RKC 8T-* WKC 8T-*	RSC 8T-* WSC 8T-*	AWM PVC Grey, 8x24 AWG, 105 °C, 5.7 mm OD, Cable #RF50753-*M, Flexlife	<p>Female</p>
RKC 8T-*/S715 WKC 8T-*/S715	RSC 8T-*/S715 WSC 8T-*/S715	AWM PVC Yellow, 8x24 AWG, 105 °C, 5.7 mm OD, Cable #RF50884-*M, Flexlife		
<p>WKC ..**</p>	RKC 8T-*/S90 WKC 8T-*/S90	RSC 8T-*/S90 WSC 8T-*/S90	AWM TPU Grey, 8x24 AWG, 90 °C, 5.7 mm OD, Cable #RF50984-*M, Cut/Abrasion Immune	1. WH 2. BN 3. GN 4. YE 5. GY 6. PK 7. BU 8. RD
	RKC 8T-*/S101 WKC 8T-*/S101	RSC 8T-*/S101 WSC 8T-*/S101	AWM TPE Grey, 8x24 AWG, 105 °C, 6.2 mm OD, Cable #RF50911-*M, Flexlife-20, High Flex Over 20 Million Cycles	
<p>RSC ..**</p>	RKC 8T-*/S618 WKC 8T-*/S618	RSC 8T-*/S618 WSC 8T-*/S618	AWM PVC Grey, 8x24 AWG Foil/Drain, 105 °C, 5.7 mm OD, Cable #RF50815-*M, RFI/EMI Shielding	<p>Male</p>
	RKC 8T-*/S1555 WKC 8T-*/S1555	RSC 8T-*/S1555 WSC 8T-*/S1555	AWM PVC Black, 7x24 AWG Foil/Drain, 105 °C, 5.1 mm OD, Cable #RF50761-*M, RFI/EMI Shielding	
<p>WSC ..**</p>	RKC 8.8T-* WKC 8.8T-*	RSC 8.8T-* WSC 8.8T-*	AWM PVC Grey, 8x24 AWG, 105 °C, 5.7 mm OD, Cable #RF50753-*M, Flexlife	1. WH 2. GN 3. YE 4. GY 5. BN 6. PK 7. BU 8. RD

We reserve the right to make technical alterations without prior notice.

* Length in meters. Standard cable lengths are 2, 4, 6, 8 and 10 meters. Consult factory for other lengths.

** Standard coupling nut material is nickel plated brass "RKC .."; "RKC .." indicates stainless steel.

10-Wire Cordsets, "C" Style Medium Plug Body

- NEMA 1, 3, 4, 6P
- IEC IP68 Protection
- 60 VAC/75 VDC, 2 A

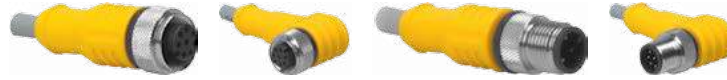

Connector Style	Female Part Number	Male Part Number	Features	Pinout
<p>RKC ..**</p>	RKC 10T-* WKC 10T-*	RSC 10T-* WSC 10T-*	AWM PVC Grey, 10x24 AWG, 105 °C, 6.2 mm OD, Cable #RF51004-*M, Flexlife®	<p>Female</p> <p>1. WH 2. BN 3. GN 4. YE 5. GY 6. PK 7. BU 8. RD 9. OG 10. TN</p> <p>Male</p>
<p>WKC ..**</p>	RKC 10T-*/S90 WKC 10T-*/S90	RSC 10T-*/S90 WSC 10T-*/S90	AWM TPU Grey, 10x24 AWG, 90 °C, 6.2 mm OD Cable #RF51005-*M, Cut/Abrasion Immune	
<p>RSC ..**</p>	RKC 10T-*/S101 WKC 10T-*/S101	RSC 10T-*/S101 WSC 10T-*/S101	AWM TPE Black, 10x24 AWG, 105 °C, 7.0 mm OD, Cable #RF51077-*M, Flexlife-20, High Flex Over 20 Million Cycles	
<p>WSC ..**</p>	RKC 10T-*/S618 WKC 10T-*/S618	RSC 10T-*/S618 WSC 10T-*/S618	AWM PVC Black, 10x24 AWG Foil/Drain, 105 °C, 6.6 mm OD, Cable #RF51076-*M, RFI/EMI Shielding	

We reserve the right to make technical alterations without prior notice.

* Length in meters. Standard cable lengths are 2, 4, 6, 8 and 10 meters. Consult factory for other lengths.
 ** Standard coupling nut material is nickel plated brass "RKC .."; "RKC .." indicates stainless steel.

12-Wire Cordsets, "C" Style Medium Plug Body

- NEMA 1, 3, 4, 6P
- IEC IP68 Protection
- 60 VAC/75 VDC, 2 A

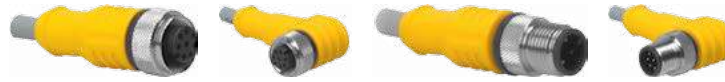

Connector Style	Female Part Number	Male Part Number	Features	Pinout
<p>RKC ..**</p>	RKC 12T-* WKC 12T-*	RSC 12T-* WSC 12T-*	AWM PVC Grey, 12x24 AWG, 105 °C, 6.3 mm OD, Cable #RF50991-*, Flexlife®	<p>Female</p> <p>1. WH 2. BN 3. GN 4. YE 5. GY 6. PK 7. BU 8. RD 9. TN 10. TN 11. BK 12. VT</p> <p>Male</p>
<p>WKC ..**</p>	RKC 12T-*/S90 WKC 12T-*/S90	RSC 12T-*/S90 WSC 12T-*/S90	AWM TPU Grey, 12x24 AWG, 90 °C, 6.0 mm OD, Cable #RF50990-*, Cut/Abrasion Immune	
<p>RSC ..**</p>	RKC 12T-*/S90 WKC 12T-*/S90	RSC 12T-*/S101 WSC 12T-*/S101	AWM TPE Black, 12x24 AWG, 105 °C, 7.6 mm OD, Cable #RF50943-*, Flexlife-20, High Flex Over 20 Million Cycles	
<p>WSC ..**</p>	RKC 12T-*/S618 WKC 12T-*/S618	RSC 12T-*/S618 WSC 12T-*/S618	AWM PVC Black, 12x24 AWG Foil/Drain, 105 °C, 6.7 mm OD, Cable #RF50755-*, RFI/EMI Shielding	

We reserve the right to make technical alterations without prior notice.

* Length in meters. Standard cable lengths are 2, 4, 6, 8 and 10 meters. Consult factory for other lengths.

** Standard coupling nut material is nickel plated brass "RKC .."; "RKC .." indicates stainless steel.

3 and 4-Wire Cordsets, "L" Style Compact Plug Body

- NEMA 1, 3, 4, 6P
- IEC IP68 Protection
- 250 V, 4 A



Connector Style	Female Part Number	Male Part Number	Features	Pinout
<p>RKL ..**</p>	RKL 4-*	RSL 4-*	ITC/PLTC PVC Grey, 3x22 AWG, 105 °C, 5.1 mm OD, Cable #RF52081- <i>*M</i> , Flexlife®	<p>1. BN 2. N/C 3. BU 4. BK</p> <p>Female</p>
	RKL 4-*/S90	RSL 4-*/S90	AWM TPU Grey, 3x22 AWG, 90 °C, 4.8 mm OD, Cable #RF52080- <i>*M</i> , Cut/Abrasion Immune	
<p>RSL ..**</p>	RKL 4.4-*	RSL 4.4-*	ITC/PLTC PVC Grey, 4x22 AWG, 105 °C, 5.3 mm OD, Cable #RF50516- <i>*M</i> , Flexlife	<p>1. BN 2. WH 3. BU 4. BK</p> <p>Male</p>
	RKL 4.4-*/S90	RSL 4.4-*/S90	AWM TPU Grey, 4x22 AWG, 90 °C, 5.1 mm OD, Cable #RF50532- <i>*M</i> , Cut/Abrasion Immune	
	RKL 4.4-*/S715	RSL 4.4-*/S715	ITC/PLTC PVC Yellow, 4x22 AWG, 105 °C, 5.3 mm OD, Cable #RF50530- <i>*M</i> , Flexlife	

* Length in meters. Standard cable lengths are 2, 4, 6, 8 and 10 meters. Consult factory for other lengths.

** Standard coupling nut material is nickel plated brass "RKL ..".

We reserve the right to make technical alterations without prior notice.

Cordsets

3 and 4-Wire Cordsets, "G" Style Large Plug Body

- NEMA 1, 3, 4, 6P
- IEC IP68 Protection
- 250 V, 4 A



Connector Style	Female Part Number	Male Part Number	Features	Pinout
<p>RKG ..**</p>	RKG 4T-*	RSG 4T-*	ITC/PLTC PVC Yellow, 3x18 AWG, 105 °C, 6.2 mm OD, Cable #RF50513-*M, Flexlife®, tray rated	1. BN 2. N/C 3. BU 4. BK
	RKG 4T-*/S600	RSG 4T-*/S600	SJOOW, CPE Yellow, 3x18 AWG, 105 °C, 8.0 mm OD, Cable #RF50654-*M, Weld Flash Immune, Flame Resistance	
	RKG 4.4T-*	RSG 4.4T-*	ITC/PLTC PVC Yellow, 4x18 AWG, 105 °C, 6.7 mm OD, Cable #RF50579-*M, Flexlife	<p>Female</p>
	RKG 4.4T-*/S90	RSG 4.4T-*/S90	AWM TPU Yellow, 4x18 AWG, 90 °C, 7.2 mm OD, Cable #RF50544-*M, Cut/Abrasion Immune	
	RKG 4.4T-*/S101/S849	RSG 4.4T-*/S101/S849	AWM TPE Grey, 4x22 AWG, 105 °C, 5.1 mm OD, Cable #RF50941-*M, Flexlife-20, High Flex - Over 20 Million Cycles	
	RKG 4.4T-*/S101	RSG 4.4T-*/S101	AWM TPE Yellow, 4x18 AWG, 105 °C, 6.2 mm OD, Cable #RF50968-*M, Flexlife-20, High Flex - Over 20 Million Cycles	
	RKG 4.4T-*/S529	RSG 4.4T-*/S529	TPU/Heavy Braid Double Jacket Yellow, 4x20 AWG, 90 °C, 5.7 mm OD, Cable #RF50526-*M, Cut/Abrasion Immune, Braided Mechanical Shield	
RKG 4.4T-*/S1587	RSG 4.4T-*/S1587	ITC/PLTC TPE Yellow, 4x18 AWG, 105 °C, 6.9 mm OD, Cable #RF50956-*M, Weldlife, Weld Flash Immune	<p>Male</p>	

We reserve the right to make technical alterations without prior notice.

* Length in meters. Standard cable lengths are 2, 4, 6, 8 and 10 meters. Consult factory for other lengths.

** Standard coupling nut material is nickel plated brass "RKG .."; "RKGV .." indicates stainless steel.

4, 5 and 6-Wire Cordsets, "G" Style Large Plug Body

- NEMA 1, 3, 4, 6P
- IEC IP68 Protection
- 250 V, 4 A (4 & 5 pole)
- 60 VAC/75 VDC, 2 A (6 pole)



Connector Style	Female Part Number	Male Part Number	Features	Pinout
<p>RKG ..**</p>	RKG 4.4T-*/S600	RSG 4.4T-*/S600	SJOOW, CPE Yellow, 4x18 AWG, 105 °C, 8.5 mm OD, Cable #RF50644-*/M, Weld Flash Immune Flame Resistance	<p>Female</p> <p>1. BN 2. WH 3. BU 4. BK</p> <p>Male</p>
	RKG 4.5T-*	RSG 4.5T-*	ITC/PLTC PVC Grey, 5x22 AWG, 105 °C, 5.7 mm OD, Cable #RF50543-*/M, Flexlife®	<p>Female</p> <p>1. BN 2. WH 3. BU 4. BK 5. GY</p> <p>Male</p>
	RKG 4.5T-*/S90/S715	RSG 4.5T-*/S90/S715	AWM TPU Yellow, 5x18 AWG, 90 °C, 7.2 mm OD, Cable #RF50751-*/M, Cut/Abrasion Immune	<p>Female</p> <p>1. BN 2. WH 3. BU 4. BK 5. GN/YE</p> <p>Male</p>
RKG 4.5T-*/S600	RSG 4.5T-*/S600	SJOOW CPE Yellow, 5x18 AWG, 105 °C, 9.4 mm OD, Cable #RF50937-*/M, Weld Flash Immune, Flame Resistance	<p>Female</p> <p>1. BN 2. WH 3. BU 4. BK 5. GY</p>	
<p>RSG ..**</p>	RKG 6T-*	RSG 6T-*	AWM PVC Grey, 6x24 AWG, 105 °C, 5.1 mm OD, Cable #RF50608-*/M, Flexlife	<p>Female</p> <p>1. BN 2. WH 3. BU 4. BK 5. GY 6. PK</p> <p>Male</p>
	RKG 6T-*/S90	RSG 6T-*/S90	AWM TPU Grey, 6x24 AWG, 90 °C, 5.1 mm OD, Cable #RF50646-*/M, Cut/Abrasion Immune	

We reserve the right to make technical alterations without prior notice.

* Length in meters. Standard cable lengths are 2, 4, 6, 8 and 10 meters. Consult factory for other lengths.

** Standard coupling nut material is nickel plated brass "RKG .."; "RKGV .." indicates stainless steel.

8, 10 and 12-Wire Cordsets, "G" Style Large Plug Body

- NEMA 1, 3, 4, 6P
- IEC IP68 Protection
- 60 VAC/75 VDC, 2 A



Connector Style	Female Part Number	Male Part Number	Features	Pinout
<p>RKG ..**</p>	RKG 8T-*	RSG 8T-*	AWM PVC Grey, 8x24 AWG, 105 °C, 5.7 mm OD, Cable #RF50753-*M, Flexlife®, CSA Approved	<p>Female</p> <p>1. WH 2. BN 3. GN 4. YE 5. GY 6. PK 7. BU 8. RD</p> <p>Male</p>
	RKG 8T-*/S90	RSG 8T-*/S90	AWM TPU Grey, 8x24 AWG, 90 °C, 5.7 mm OD, Cable #RF50984-*M, Cut/Abrasion Immune, CSA Approved	<p>Female</p> <p>Male</p>
	RKG 10T-*	RSG 10T-*	AWM PVC Grey, 10x24 AWG, 105 °C, 6.2 mm OD, Cable #RF51004-*M, Flexlife	<p>Female</p> <p>1. WH 2. BN 3. GN 4. YE 5. GY 6. PK 7. BU 8. RD</p> <p>Male</p>
	RKG 10T-*/S618	RSG 10T-*/S618	AWM PVC Black, 10x24 AWG, Foil/Drain, 105 °C, 6.6 mm OD, Cable #RF51076-*M, RFI/EMI shielding	<p>Female</p> <p>9. OG 10. TN</p> <p>Male</p>
	RKG 12T-*	RSG 12T-*	AWM PVC Grey, 12x24 AWG, 105 °C, 6.3 mm OD, Cable #RF50991-*M, Flexlife	<p>Female</p> <p>7. BU 8. RD 9. OG 10. TN</p> <p>Male</p>
	RKG 12T-*/S618	RSG 12T-*/S618	AWM PVC Black, 12x24 AWG, Foil/Drain, 105 °C, 6.7 mm OD, Cable #RF50755-*M, RFI/EMI shielding	<p>Female</p> <p>11. BK 12. VT</p> <p>Male</p>

We reserve the right to make technical alterations without prior notice.

* Length in meters. Standard cable lengths are 2, 4, 6, 8 and 10 meters. Consult factory for other lengths.

** Standard coupling nut material is nickel plated brass "RKG .."; "RKGV .." indicates stainless steel.

3, 4 and 5-Wire Cordsets, "A" Style Extreme Duty Armored Plug Body - 18 AWG

- Shield to Coupling Nut
- NEMA 1, 3, 4, 6P and IEC IP68 Protection
- 250 V, 4 A

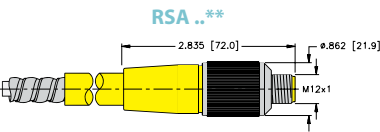
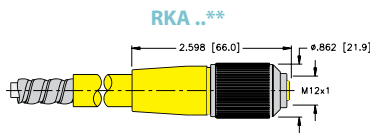

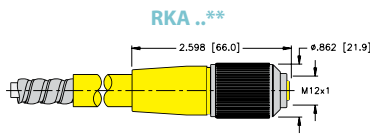
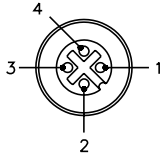
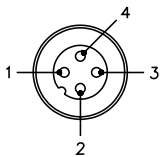
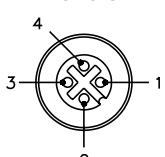
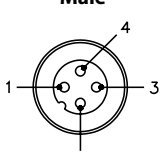
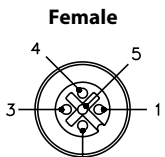
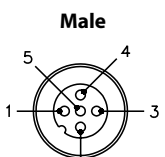
Connector Style	Female Part Number	Male Part Number	Features	Pinout
	RKA 4A-*	RSA 4A-*	Interlock Al Armor, ITC-ER/PLTC-ER, PVC Yellow, 3x18 AWG, 105 °C, 14.9 mm OD, Cable #RF51040-*M, Extreme Duty Armored Cable, Tray Rated	<p>Female</p>  <p>1. BK 2. N/C 3. WH 4. GN</p> <p>Male</p> 
	RKA 4.4A-*	RSA 4.4A-*	Interlock Al Armor, ITC-ER/PLTC-ER, PVC Yellow, 4x18 AWG, 105 °C, 15.2 mm OD, Cable #RF51041-*M, Extreme Duty Armored Cable, Tray Rated	<p>Female</p>  <p>1. BK 2. WH 3. RD 4. GN</p> <p>Male</p> 
	RKA 4.5A-*	RSA 4.5A-*	Interlock Al Armor, MC PVC Yellow, 5x18 AWG, 90 °C, 14.9 mm OD, Cable #RF51042-*M, Extreme Duty Armored Cable	<p>Female</p>  <p>1. BK 2. WH 3. RD 4. GN 5. OG</p> <p>Male</p> 

We reserve the right to make technical alterations without prior notice.

Cordsets

* Length in meters. Standard cable lengths are 2, 4, 6, 8 and 10 meters. Consult factory for other lengths.
 ** Standard coupling nut material is nickel plated brass "RKA .."; "RKAV .." indicates stainless steel.

- Shield to Coupling Nut
- IEC IP 67 Protection
- 250 V, 4 A (4 & 5 pole)
- 60 VAC/75 VDC, 2 A (6 pole)



Connector Style	Female Part Number	Male Part Number	Features	Pinout
<p>RKS ..**</p>	RKS 4.4T-* WKS 4.4T-*	RSS 4.4T-* WSS 4.4T-*	ITC/PLTC PVC Grey, 4x22 AWG, 105 °C, 6.2 mm OD, Cable #RF50729-*M, RFI/EMI shielding, Tray rated	<p>Female</p> <p>Male</p>
	RKS 4.4T-*/S90 WKS 4.4T-*/S90	RSS 4.4T-*/S90 WSS 4.4T-*/S90	AWM TPU Grey, 4x22 AWG, 90 °C, 6.2 mm OD, Cable #RF50810-*M, RFI/EMI shielding	
	RKS 4.4T-*/S824 WKS 4.4T-*/S824	RSS 4.4T-*/S824 WSS 4.4T-*/S824	ITC/PLTC PVC Grey, 4x22 AWG, 105 °C, 6.2 mm OD, Cable #RF50729-*M, RFI/EMI shielding, Tray rated	
<p>WKS ..**</p>	RKS 4.5T-* WKS 4.5T-*	RSS 4.5T-* WSS 4.5T-*	ITC/PLTC PVC Grey, 5x22 AWG, 105 °C, 6.6 mm OD, Cable #RF50713-*M, RFI/EMI shielding, Tray rated	<p>Female</p> <p>Male</p>
<p>RSS ..**</p>	RKS 6T-* WKS 6T-*	RSS 6T-* WSS 6T-*	AWM PVC Grey, 6x24 AWG, 105 °C, 6.6 mm OD, Cable #RF50814-*M, RFI/EMI shielding	<p>Female</p> <p>Male</p>
<p>WSS ..**</p>				

We reserve the right to make technical alterations without prior notice.

* Length in meters. Standard cable lengths are 2, 4, 6, 8 and 10 meters. Consult factory for other lengths.

** Standard coupling nut material is nickel plated brass "RKS .."; "RKS .." indicates stainless steel.

8, 10 and 12-Wire Cordsets, "S" Style, Shielded

- Shield to Coupling Nut
- IEC IP 67 Protection
- 60 VAC/75 VDC, 2 A



We reserve the right to make technical alterations without prior notice.

Connector Style	Female Part Number	Male Part Number	Features	Pinout
<p>RKS ..**</p>	RKS 8T-* WKS 8T-*	RSS 8T-* WSS 8T-*	AWM PVC Grey, 8x24 AWG, 105 °C, 7.2 mm OD, Cable #RF50813-*M, RFI/EMI shielding, CSA Approved	<p>Female</p> <p>Male</p>
<p>WKS ..**</p>	RKS 10T-* WKS 10T-*	RSS 10T-* WSS 10T-*	AWM PVC Grey, 10x24 AWG, 105 °C, 7.2 mm OD, Cable #RF51006-*M, RFI/EMI shielding	<p>Female</p> <p>Male</p>
<p>RSS ..**</p>				
<p>WSS ..**</p>	RKS 12T-* WKS 12T-*	RSS 12T-* WSS 12T-*	AWM PVC Grey, 12x24 AWG, 105 °C, 7.2 mm OD, Cable #RF50988-*M, RFI/EMI shielding	<p>Female</p> <p>Male</p>

* Length in meters. Standard cable lengths are 2, 4, 6, 8 and 10 meters. Consult factory for other lengths.

** Standard coupling nut material is nickel plated brass "RKS .."; "RKS SV .." indicates stainless steel.

Cordsets

3-Wire Cordsets with LEDs

- NEMA 1, 3, 4, 6P
- IEC IP68 Protection
- 10-30 VDC, 4 A



Connector Style	Female Part Number	Male Part Number	Features	Pinout
<p>RKE ..**</p>	RKE 4T-*-P7X2 WK 4T-*-P7X2	RSE 4T-*-P7X2	ITC/PLTC PVC Grey, 3x22 AWG, 105 °C, 5.1 mm OD, Cable #RF52081-*-M, PNP Signal, Flexlife®	<p>Female</p> <p>Male</p>
	RKE 4T-*-N7X2 WK 4T-*-N7X2		ITC/PLTC PVC Grey, 3x22 AWG, 105 °C, 5.1 mm OD, Cable #RF52081-*-M, NPN Signal, Flexlife	
	RKE 4T-*-P7X2/S90 WK 4T-*-P7X2/S90	RSE 4T-*-P7X2/S90	AWM TPU Grey, 3x22 AWG, 90 °C, 4.8 mm OD, Cable #RF52080-*-M, PNP Signal, Cut/Abrasion Immune	
	RKE 4T-*-N7X2/S90 WK 4T-*-N7X2/S90		AWM TPU Grey, 3x22 AWG, 90 °C, 4.8 mm OD, Cable #RF52080-*-M, NPN Signal, Cut/Abrasion Immune	
	WK 4T-*-P7X2/S101		AWM TPE Grey, 3x22 AWG, 105 °C, 4.8 mm OD, Cable #RF52085-*-M, PNP Signal, Flexlife-20, High Flex - Over 20 Million Cycles	
	WK 4T-*-N7X2/S101		AWM TPE Grey, 3x22 AWG, 105 °C, 4.8 mm OD, Cable #RF52085-*-M, NPN Signal, Flexlife-20, High Flex - Over 20 Million Cycles	
	WK 4T-*-P7X2/S618		ITC/PLTC PVC Grey, 3x22 AWG, 105 °C, 5.1 mm OD, Cable #RF52082-*-M, PNP Signal, EMI/RFI Protection	
	WK 4T-*-N7X2/S618		ITC/PLTC PVC Grey, 3x22 AWG, 105 °C, 5.1 mm OD, Cable #RF52082-*-M, NPN Signal, EMI/RFI Protection	
	RKE 4T-*-P7X2/S715 WK 4T-*-P7X2/S715	RSE 4T-*-P7X2/S715	ITC/PLTC PVC Yellow, 3x22 AWG, 105 °C, 5.1 mm OD, Cable #RF52087-*-M, PNP Signal, Flexlife	
	RKE 4T-*-N7X2/S715 WK 4T-*-N7X2/S715		ITC/PLTC PVC Yellow, 3x22 AWG, 105 °C, 5.1 mm OD, Cable #RF52087-*-M, NPN Signal, Flexlife	
<p>WK ..**</p> <p>Output (Yellow) Power (Green)</p>	RKE 4T-*-P7X2/S824 WK 4T-*-P7X2/S824	RSE 4T-*-P7X2/S824	ITC/PLTC PVC Grey, 3x22 AWG, 105 °C, 5.1 mm OD, Cable #RF52081-*-M, PNP Signal, Tray Rated, Flexlife	
	RKE 4T-*-N7X2/S824 WK 4T-*-N7X2/S824		ITC/PLTC PVC Grey, 3x22 AWG, 105 °C, 5.1 mm OD, Cable #RF52081-*-M, NPN Signal, Tray Rated, Flexlife	

* Length in meters. Standard cable lengths are 2, 4, 6, 8 and 10 meters. Consult factory for other lengths.

** Standard coupling nut material is nickel plated brass "RKE..".

We reserve the right to make technical alterations without prior notice.

4-Wire Cordsets with LEDs

- NEMA 1, 3, 4, 6P
- IEC IP68 Protection
- 10-30 VDC, 4 A



Connector Style	Female Part Number	Male Part Number	Features	Pinout
<p>RKE ..**</p> <p>1.807 [45.9] ϕ.532 [13.5]</p> <p>M12x1</p> <p>LED 4x</p> <p>WK ..**</p> <p>Output (Yellow)</p> <p>Power (Green)</p> <p>1.700 [43.2] LED 2x</p> <p>1.142 [29.0]</p> <p>ϕ.551 [14.0] M12x1</p> <p>RSE ..**</p> <p>2.173 [55.2] ϕ.531 [13.5]</p> <p>M12x1</p> <p>LED 4x</p>	RKE 4.4T-*-P7X2 WK 4.4T-*-P7X2	RSE 4.4T-*-P7X2	ITC/PLTC PVC Grey, 4x22 AWG, 105 °C, 5.3 mm OD, Cable #RF50516-*M, PNP Signal, Flexlife®	<p>Female</p> <p>1. BN 2. WH 3. BU 4. BK</p> <p>Male</p>
	RKE 4.4T-*-N7X2 WK 4.4T-*-N7X2	RSE 4.4T-*-N7X2	ITC/PLTC PVC Grey, 4x22 AWG, 105 °C, 5.3 mm OD Cable #RF50516-*M NPN Signal, Flexlife	
	RKE 4.4T-*-P7X2/S90 WK 4.4T-*-P7X2/S90	RSE 4.4T-*-P7X2/S90	ITC/PLTC PVC Grey, 4x22 AWG, 105 °C, 5.3 mm OD, Cable #RF50516-*M, PNP Signal, Flexlife	
	WK 4.4T-*-N7X2/S90		ITC/PLTC PVC Grey, 4x22 AWG, 105 °C, 5.3 mm OD, Cable #RF50516-*M, NPN Signal, Flexlife	
	RKE 4.4T-*-P7X2/S101 WK 4.4T-*-P7X2/S101	RSE 4.4T-*-P7X2/S101	AWM TPE Grey, 4x22 AWG, 105 °C, 5.1 mm OD, Cable #RF50941-*M, PNP Signal, Flexlife-20, High Flex - Over 20 Million Cycles	
	WK 4.4T-*-N7X2/S101		AWM TPE Grey, 4x22 AWG, 105 °C, 5.1 mm OD, Cable #RF50941-*M, NPN Signal, Flexlife-20, High Flex - Over 20 Million Cycles	

We reserve the right to make technical alterations without prior notice.

* Length in meters. Standard cable lengths are 2, 4, 6, 8 and 10 meters. Consult factory for other lengths.
 ** Standard coupling nut material is nickel plated brass "RKE ..".

Cordsets

4 and 5-Wire Cordsets with LEDs

- NEMA 1, 3, 4, 6P
- IEC IP68 Protection
- 10-30 VDC, 4 A



Connector Style	Female Part Number	Features	Pinout
<p>RKE ..**</p>	WK 4.4T-*-P7X2/S618	ITC/PLTC PVC Grey, 4x22 AWG, 105 °C, 5.3 mm OD, Cable #RF50577-*M, PNP Signal, EMI/RFI Protection	<p>Female</p>
	WK 4.4T-*-N7X2/S618	ITC/PLTC PVC Grey, 4x22 AWG, 105 °C, 5.3 mm OD, Cable #RF50577-*M, NPN Signal, EMI/RFI Protection	
<p>WK ..**</p>	WK 4.4T-*-P7X2/S824	ITC/PLTC PVC Grey, 4x22 AWG, 105 °C, 5.3 mm OD, Cable #RF50698-*M, PNP Signal, Tray Rated	<p>Female</p>
	WK 4.4T-*-P7X2/S824	ITC/PLTC PVC Grey, 4x22 AWG, 105 °C, 5.1 mm OD, Cable #RF50698-*M, NPN Signal, Tray Rated	
	WK 4.5T-*-P7X2	ITC/PLTC PVC Grey, 5x22 AWG, 105 °C, 5.7 mm OD, Cable #RF50543-*M, PNP Signal, Flexlife®	
	RKE 4.5T-*-P7X2	ITC/PLTC PVC Grey, 5x22 AWG, 105 °C, 5.7 mm OD, Cable #RF50543-*M, PNP Signal, Flexlife	

* Length in meters. Standard cable lengths are 2, 4, 6, 8 and 10 meters. Consult factory for other lengths.

** Standard coupling nut material is nickel plated brass "WK .."; "WKV .." Indicates stainless steel.

We reserve the right to make technical alterations without prior notice.

4 and 5-Wire Cordsets with LEDs

- NEMA 1, 3, 4, 6P
- IEC IP68 Protection
- 10-30 VDC, 4 A



Connector Style	Female Part Number	Features	Pinout
<p>WK ..**</p> <p>Output (Yellow)</p> <p>Output (Yellow)</p> <p>Power (Green)</p> <p>LED 3x</p> <p>1.700 [43.2]</p> <p>1.142 [29.0]</p> <p>ø.551 [14.0]</p> <p>M12x1</p>	WK 4.4T-*-P7X3	ITC/PLTC PVC Grey, 4x22 AWG, 105 °C, 5.3 mm OD, Cable #RF50516-*M, PNP Signal, Flexlife®	<p>Female</p>
	WK 4.4T-*-P7X3/S90	AWM TPU Grey, 4x22 AWG, 90 °C, 5.1 mm OD, Cable #RF50532-*M, PNP Signal, Cut/Abrasion Immune	
	WK 4.4T-*-P7X3/S101	AWM TPE Grey, 4x22 AWG, 105 °C, 5.1 mm OD, Cable #RF50941-*M, PNP Signal, Flexlife-20, High Flex - Over 20 Million Cycles	

* Length in meters. Standard cable lengths are 2, 4, 6, 8 and 10 meters. Consult factory for other lengths.
 ** Standard coupling nut material is nickel plated brass "WK.."; "WKV.." Indicates stainless steel.

We reserve the right to make technical alterations without prior notice.

Cordsets

LED Diagrams

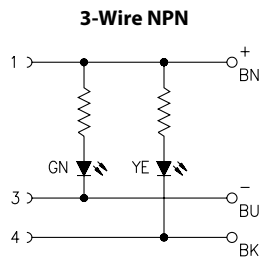

1. + Voltage (Green LED)
2. N/C
3. Common
4. Output (Yellow LED)

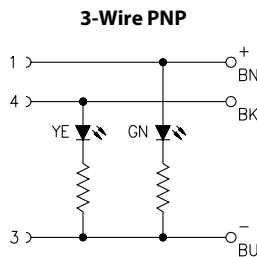

1. + Voltage (Green LED)
2. NC
3. Common
4. Output (Yellow LED)

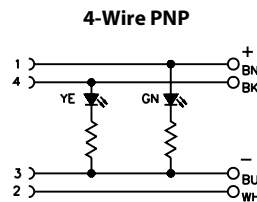

1. + Voltage (Green LED)
2. Output
3. Common
4. Output (Yellow LED)

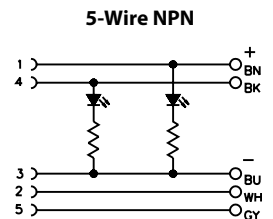

1. + Voltage (Green LED)
2. Output
3. Common
4. Output (Yellow LED)
5. Ground

3 and 4-Wire Cordsets with and without LEDs, Rubber

- NEMA 1, 3, 4, 6P
- IEC IP68 Protection
- 10-30 VDC, 4 A



Connector Style	Female Part Number	Features	Pinout
<p>WKE ..**</p>	<p>WKE 4T-*-P7X2/S600</p>	<p>SJOOW CPE Yellow 3x18 AWG, 105 °C 8.0 mm OD, Cable #RF50654-*M, PNP Signal, Weld Flash Immune, Flame Immune</p>	<p>Female</p>
	<p>WKE 4T-*-N7X2/S600</p>	<p>SJOOW CPE Yellow 3x18 AWG, 105 °C, 8.0 mm OD, Cable #RF50654-*M, NPN Signal, Weld Flash Immune, Flame Immune</p>	
<p>WKE ..**</p>	<p>WKE 4.4T-2-P7X3/S600</p>	<p>SJOOW CPE Yellow, 4x18 AWG, 105 °C, 8.5 mm OD, Cable #RF50644-*M, PNP Signal, Weld Flash Immune, Flame Immune</p>	<p>Female</p>

* Length in meters. Standard cable lengths are 2, 4, 6, 8 and 10 meters. Consult factory for other lengths.

** Standard coupling nut material is nickel plated brass.

We reserve the right to make technical alterations without prior notice.

8-Pin Cordset with LEDs

- NEMA 1, 3, 4, 6P
- IEC IP68 Protection
- 5-30 VDC



Connector Style	Female Part Number	Features	Pinout
<p>E-WK..**</p>	<p>E-WKC 8T-PX3-930-*</p>	<p>AWM PVC, Black, 8x24 AWG, 105 °C, 7.2 mm OD, Cable #RF50930-*M, 3 indicator LEDs in translucent molded connector-for use with Kübler Incremental Encoders</p>	<p>Female</p> <p>1. WH 2. BN 3. GN 4. YE 5. GY 6. PK 7. BU 8. RD</p>

We reserve the right to make technical alterations without prior notice.

- * Length in meters. Standard cable lengths are 2, 4, 6, 8 and 10 meters.
- ** Standard coupling nut material is nickel plated brass "WKC.."; "WKC.." indicates stainless steel.

Wiring Diagram

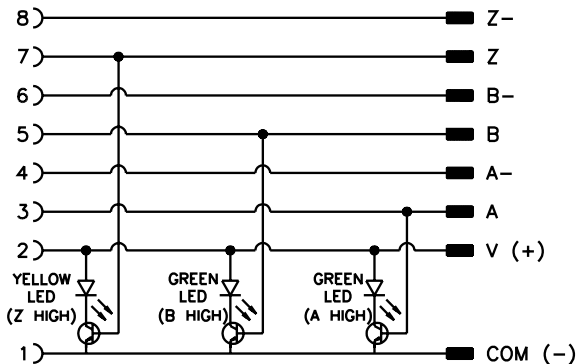

8-Pin Cordset with Encoder



Note: LEDs for indication of channels A, B and Z. Green LEDs indicate channels A and B, while amber is used for the index channel. LEDs can also be used during machine set-up for home position indication, and provide operational status of encoder output channels.

3 and 5-Wire Cordsets, Reverse Key (B-Code)

- NEMA 1, 3, 4, 6P
- IEC IP68 Protection
- 250 V, 4 A



Connector Style	Female Part Number	Male Part Number	Features	Pinout
<p>WAKW ..**</p>	<p>WAKW 4T-*/S626 WWAKW 4T-*/S626</p>	<p>WASW 4T-*/S626 WWASW 4T-*/S626</p>	<p>ITC/PLTC PVC Grey, 3x20 AWG, 105 °C, 5.3 mm OD, Cable #RF51926-*M, Flexlife®</p>	<p>1. BN 2. BU 4. GN/YE</p>
<p>WWAKW ..**</p>	<p>WAKW 4.5T-* WWAKW 4.5T-*</p>	<p>WASW 4.5T-* WWASW 4.5T-*</p>	<p>ITC/PLTC PVC Grey, 4x22, 1x20 AWG, 105 °C, 6.0 mm OD, Cable #RF50563-*M, Flexlife</p>	<p>1. BN 2. WH 3. BU 4. BK 5. GN/YE</p>
<p>WASW ..**</p>	<p>WAKW 4.5T-*/S101 WWAKW 4.5T-*/S101</p>	<p>WASW 4.5T-*/S101 WWASW 4.5T-*/S101</p>	<p>AWM TPE Grey, 5x22 AWG, 105 °C, 5.7 mm OD, Cable #RF50909-*M, Flexlife-20, High Flex - Over 20 Million Cycles</p>	<p>1. BN 2. WH 3. BU 4. BK 5. GY</p>
<p>WWASW ..**</p>	<p>WAKW 4.5T-*/S618 WWAKW 4.5T-*/S618</p>	<p>WASW 4.5T-*/S618 WWASW 4.5T-*/S618</p>	<p>ITC/PLTC PVC Grey, 5x22 AWG Foil/Drain, 105 °C, 5.7 mm OD, Cable #RF50609-*M, EMI/RFI Protection</p>	<p>1. BN 2. WH 3. BU 4. BK 5. Drain</p>
<p>WAKW 4.5T-*/S653 WWAKW 4.5T-*/S653</p>	<p>WASW 4.5T-*/S653 WWASW 4.5T-*/S653</p>	<p>ITC/PLTC PVC Grey, 4x22 AWG Foil/Drain, 105 °C, 5.3 mm OD, Cable #RF50577-*M, EMI/RFI Protection</p>	<p>1. BN 2. WH 3. BU 4. BK 5. Drain</p>	

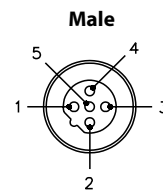
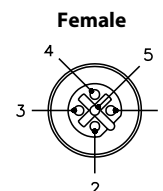

We reserve the right to make technical alterations without prior notice.

* Length in meters. Standard cable lengths are 2, 4, 6, 8 and 10 meters. Consult factory for other lengths.

** Standard coupling nut material is nickel plated brass "WAKW.."; "WAKKW.." indicates nylon and "WAKVW.." indicates stainless steel.

Spiral Cordsets, Standard Plug Body

- NEMA 1, 3, 4, 6P
- IEC IP68 Protection
- 250 V, 4 A



Connector Style	Female Part Number	Features	Pinout
<p>RK ..-SP**</p>	<p>RK 4T-3.3/S90-SP WK 4T-3.3/S90-SP</p>	<p>AWM TPU Grey, 3x22 AWG, 90 °C, 5.1 mm OD, for repetitive motion 3-wire DC applications</p>	<p>1. BN 3. BU 4. BK</p>
	<p>RK 4.4T-3.3/S90-SP WK 4.4T-3.3/S90-SP</p>	<p>AWM TPU Grey, 4x22 AWG, 90 °C, 5.1 mm OD, for repetitive motion 4-wire DC applications</p>	<p>1. BN 2. WH 3. BU 4. BK</p>
<p>WK ..-SP**</p>	<p>RK 4.4T-3/S90-SP/S669 WK 4.4T-3/S90-SP/S669</p>	<p>AWM TPU Black, 4x26 AWG, 90 °C, 4.2 mm OD, for repetitive motion, 4-wire DC applications, Eurofast connector with Picofast® coil cord</p>	<p>1. BN 2. WH 3. BU 4. BK</p>
	<p>RK 4.5T-3.3/S90-SP WK 4.5T-3.3/S90-SP</p>	<p>AWM TPU Grey, 5x22 AWG, 90 °C, 5.3 mm OD, for repetitive motion 5-wire DC applications</p>	<p>1. BN 2. WH 3. BU 4. BK 5. GY</p>

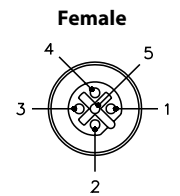
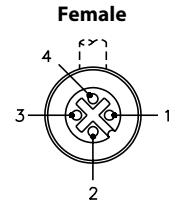

Cordsets

We reserve the right to make technical alterations without prior notice.

* Length in meters. Standard cable length is 3.3 meters (Picofast coil standard is 3 meters). Consult factory for other lengths.
 ** Standard coupling nut material is nickel plated brass .. "RK(WK).."; "RKK(WKK).." indicates nylon and "RKV(WKV)" indicates 316 stainless steel.

Spiral Cordsets, Standard Plug Body

- NEMA 1, 3, 4, 6P
- IEC IP68 Protection
- 250 V, 4 A



Connector Style	Female Part Number	Features	Pinout
<p>RS ..-SP**</p>	RS 4T-3.3/S90-SP WS 4T-3.3/S90-SP	AWM TPU Grey, 3x22 AWG, 90 °C, 5.1 mm OD, for repetitive motion 3-wire DC applications	1. BN 3. BU 4. BK
	RS 4.4T-3.3/S90-SP WS 4.4T-3.3/S90-SP	AWM TPU Grey, 4x22 AWG, 90 °C, 5.1 mm OD, for repetitive motion 4-wire DC applications	1. BN 2. WH 3. BU 4. BK
<p>WS ..-SP**</p>	RS 4.4T-3/S90-SP/S669 WS 4.4T-3/S90-SP/S669	AWM TPU Black, 4x26 AWG, 90 °C, 4.2 mm OD, for repetitive motion 4-wire DC applications, Eurofast connector with Picofast® coil cord	1. BN 2. WH 3. BU 4. BK
	RS 4.5T-3.3/S90-SP WS 4.5T-3.3/S90-SP	AWM TPU Grey, 5x22 AWG, 90 °C, 5.3 mm OD, for repetitive motion 5-wire DC applications	1. BN 2. WH 3. BU 4. BK 5. GY

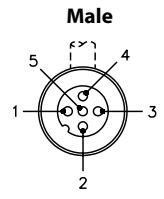
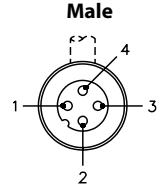

* Length in meters. Standard cable length is 3.3 meters (Picofast coil standard is 3 meters). Consult factory for other lengths.
 ** Standard coupling nut material is nickel plated brass.. "RS (WS).."; "RSK (WSK).." indicates nylon and "RSV (WSV)" indicates stainless steel.

We reserve the right to make technical alterations without prior notice.

Spiral Cordsets, "C" Style Medium Plug Body

- NEMA 1, 3, 4, 6P
- IEC IP68 Protection
- 60 VAC/75 VDC, 2A



Connector Style	Female Part Number	Features	Pinout
<p>RKC ..-SP**</p>	<p>RKC 6T-3.3/S90-SP WKC 6T-3.3/S90-SP</p>	<p>AWM TPU Black, 6x24 AWG, 90 °C, 5.1 mm OD, for repetitive motion 6-wire DC applications</p>	<p>Female</p>
<p>WK ..-SP**</p>	<p>RKC 8.6T-3.3/S90-SP/CS10451 WKC 8.6T-3.3/S90-SP/CS10451</p>	<p>AWM TPU Black, 6x24 AWG, 90 °C, 5.1 mm OD, for repetitive motion 6-wire DC applications</p>	<p>Female</p>

* Length in meters. Standard cable length is 3.3 meters. Consult factory for other lengths.
 ** Standard coupling nut material is nickel plated brass .. "RKC(WKC).."; "RKC(WKCV)" indicates stainless steel.

We reserve the right to make technical alterations without prior notice.

Cordsets

Spiral Cordsets, "C" Style Medium Plug Body

- NEMA 1, 3, 4, 6P
- IEC IP68 Protection
- 60 VAC/75 VDC, 2 A



Connector Style	Male Part Number	Features	Pinout
<p>RSC ..-SP**</p>	<p>RSC 6T-3.3/S90-SP WSC 6T-3.3/S90-SP</p>	<p>AWM TPU Black, 6x24 AWG, 90 °C, 5.1 mm OD, for repetitive motion 6-wire DC applications</p>	<p>1. BN 2. WH 3. BU 4. BK 5. GY 6. PK</p>
<p>WSC ..-SP**</p>	<p>RSC 8.6T-3.3/S90-SP/CS10451 WSC 8.6T-3.3/S90-SP/CS10451</p>	<p>AWM TPU Black, 6x24 AWG, 90 °C, 5.1 mm OD, for repetitive motion 6-wire DC applications</p>	<p>1. WH 2. BK 3. PK 4. GY 5. BN 6. N/C 7. BU 8. N/C</p>

* Length in meters. Standard cable length is 3.3 meters. Consult factory for other lengths.

** Standard coupling nut material is nickel plated brass .. "RSC(WSC).."; "RSCV(WSCV)" indicates stainless steel.

We reserve the right to make technical alterations without prior notice.

8-Pin Cordsets

- NEMA 1, 3, 4, 6P
- IEC IP68 Protection
- 60 VAC/75 VDC, 2 A
- For use with Kübler by Turck's Incremental Encoders



Connector Style	Female Part Number	Male Part Number	Features	Pinout
<p>E-RKC..</p>	E-RKC 8T-930-* E-WKC 8T-930-*	E-RSC 8T-930-* E-WSC 8T-930-*	AWM PVC Black, 8x24 AWG, 105 °C, 7.2 mm OD, Cable #RF50930-*, Differential Mode Applications, RFI/EMI Protection	1. WH 2. BN 3. GN 4. YE 5. GY 6. PK 7. BU 8. RD
<p>E-WKC..</p>	E-RKC 8T-930-*/S1115 E-WKC 8T-930-*/S1115	E-RSC 8T-930-*/S1115 E-WSC 8T-930-*/S1115	AWM PVC Black, 8x24 AWG, 105 °C, 7.2 mm OD, Cable #RF50930-*, Single Ended Mode Applications, RFI/EMI Protection	1. WH 2. BN 3. GN 4. N/C 5. GY 6. N/C 7. BU 8. N/C
<p>E-RSC..</p>				
<p>E-WSC..</p>	E-RKC 8T-264-* E-WKC 8T-264-*	E-RSC 8T-264-* E-WSC 8T-264-*	AWM PVC Black, 8x24 AWG, 4 STP, 105 °C, 6.6 mm OD, Cable #RF51264-*, Differential Mode Applications, RFI/EMI Protection	1. WH 2. BN 3. GN 4. YE 5. GY 6. PK 7. BU 8. RD

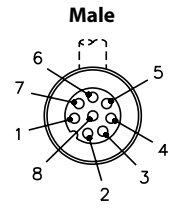
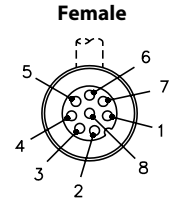

We reserve the right to make technical alterations without prior notice.

Cordsets

* Length in meters. Standard cable lengths are 2, 5, 10 and 15 meters. Consult factory for other lengths.

** Standard coupling nut material is nickel plated brass "E-RKC../E-WKC../E-RKS../E-WKS.."; "E-RKCV../E-WKCV../E-RKSV../E-WKSV.." indicates stainless steel.
STP = Shielded twisted pair.

8-Pin Cordsets

- IEC IP67
- 60 VAC/75 VDC, 2 A
- For use with Kübler by Turck's Incremental Encoders



Connector Style	Female Part Number	Male Part Number	Features	Pinout
<p>E-RKC..</p>				
<p>E-WKS..</p>	E-RKS 8T-930-* E-WKS 8T-930-*	E-RSS 8T-930-* E-WSS 8T-930-*	AWM PVC Black 8x24 AWG 105 °C 7.2 mm OD Cable #RF50930-*M, Differential Mode Applications, Shield Tied to Coupling Nut, RFI/EMI Protection	<p>Female</p>
<p>E-RSS..</p>				
<p>E-WSS..</p>	E-RKS 8T-264-* E-WKS 8T-264-*	E-RSS 8T-264-* E-WSS 8T-264-*	AWM PVC Black, 8x24 AWG, 4 STP, 105 °C, 6.6 mm OD, Cable #RF51264-*M, Differential Mode Applications, RFI/EMI Protection	<p>Male</p>

We reserve the right to make technical alterations without prior notice.

* Length in meters. Standard cable lengths are 2, 5, 10 and 15 meters. Consult factory for other lengths.

** Standard coupling nut material is nickel plated brass "E-RKC../E-WKC../E-RKS../E-WKS.."; "E-RKCV../E-WKCV../E-RKSV../E-WKSV.." indicates stainless steel.
STP = Shielded twisted pair.

3, 4, 5 and 6-Wire Washdown Cordsets

- NEMA 1, 3, 4, 6P
- IEC IP68 Protection
- Polypropylene Contact Holder, Mold Material & Cable Jacket
- High Chemical Solvent Resistance, High Tensile Strength



Connector Style	Female Part Number	Male Part Number	Features	Pinout	
<p>WD-RKCV..</p> <p>WD-WKCV..</p> <p>WD-RSCV..</p> <p>WD-WSCV..</p>	<p>WD-RKCV 4T-* WD-WKCV 4T-*</p>	<p>WD-RSCV 4T-* WD-WSCV 4T-*</p>	<p>PP White, 3x20 AWG 105 °C, 250 V, 4 A 5.1 mm OD, Cable #RF51440-*M</p>	<p>1. BN 2. N/C 3. BU 4. BK</p>	<p>Female</p> <p>Male</p>
	<p>WD-RKCV 4.4T-* WD-WKCV 4.4T-*</p>	<p>WD-RSCV 4.4T-* WD-WSCV 4.4T-*</p>	<p>PP White, 4x22 AWG 105 °C, 250 V, 4 A 4.4 mm OD, Cable #RF51359-*M</p>	<p>1. BN 2. WH 3. BU 4. BK</p>	<p>Female</p> <p>Male</p>
	<p>WD-RKCV 4.5T-* WD-WKCV 4.5T-*</p>	<p>WD-RSCV 4.5T-* WD-WSCV 4.5T-*</p>	<p>PP White, 5x22 AWG 105 °C, 250 V, 4 A 4.5 mm OD Cable #RF51466-*M</p>	<p>1. BN 2. WH 3. BU 4. BK 5. GY</p>	<p>Female</p> <p>Male</p>
	<p>WD-RKCV 6T-* WD-WKCV 6T-*</p>	<p>WD-RSCV 6T-* WD-WSCV 6T-*</p>	<p>PP White, 6x24 AWG 105 °C, 60 VAC/75 VDC, 2 A 4.5 mm OD Cable #RF51467-*M</p>	<p>1. BN 2. WH 3. BU 4. BK 5. GY 6. PK</p>	<p>Female</p> <p>Male</p>

We reserve the right to make technical alterations without prior notice.

Cordsets

* Length in meters. Standard cable lengths are 2, 5, 10 and 15 meters. Consult factory for other lengths. Standard coupling nut material is stainless steel.

8, 10 and 12-Wire Washdown Cordsets

- NEMA 1, 3, 4, 6P
- IEC IP68 Protection
- Polypropylene Contact Holder, Mold Material & Cable Jacket
- High Chemical Solvent Resistance, High Tensile Strength



Connector Style	Female Part Number	Male Part Number	Features	Pinout
<p>WD-RKCV..</p>	<p>WD-RKCV 8T-* WD-WKCV 8T-*</p>	<p>WD-RSCV 8T-* WD-WSCV 8T-*</p>	<p>PP White, 8x24 AWG, 105 °C, 60 VAC/75 VDC, 2 A, 5.1 mm OD, Cable #RF51465-*M</p>	<p>Female</p> <p>1. WH 2. BN 3. GN 4. YE 5. GY 6. PK 7. BU 8. RD</p> <p>Male</p>
<p>WD-WKCV..</p>	<p>WD-RKCV 10T-* WD-WKCV 10T-*</p>	<p>WD-RSCV 10T-* WD-WSCV 10T-*</p>	<p>PP White, 10x24 AWG, 105 °C, 60 VAC/75 VDC, 2 A, 5.7 mm OD, Cable #RF51602-*M</p>	<p>Female</p> <p>1. WH 2. BN 3. GN 4. YE 5. GY 6. PK 7. BU 8. RD 9. OG 10. TN</p> <p>Male</p>
<p>WD-RSCV..</p>				
<p>WD-WSCV..</p>	<p>WD-RKCV 12T-* WD-WKCV 12T-*</p>	<p>WD-RSCV 12T-* WD-WSCV 12T-*</p>	<p>PP White, 12x24 AWG, 105 °C, 60 VAC/75 VDC, 2 A, 5.7 mm OD, Cable #RF51464-*M</p>	<p>Female</p> <p>1. WH 2. BN 3. GN 4. YE 5. GY 6. PK 7. BU 8. RD 9. OG 10. TN 11. BK 12. VT</p> <p>Male</p>

We reserve the right to make technical alterations without prior notice.

* Length in meters. Standard cable lengths are 2, 4, 5, 6, 8 and 10 meters. Consult factory for other lengths. Standard coupling nut material is stainless steel.

3, 4 and 5-Wire True Torque Cordsets

- Integrated Torque Control System
- IEC IP67
- 250 V, 4 A (3 & 4-wires) 60 V, 4 A (5-wire)



Connector Style	Female Part Number	Male Part Number	Features	Pinout
NM-RKC.. 	NM-RKC 4T-*/S849 NM-WKC 4T-*/S849	NM-RSC 4T-*/S849 NM-WSC 4T-*/S849	PVC Grey, 3x22 AWG, 80 °C, 5.2 mm OD	Female
	NM-RKC 4T-*/S90/S849 NM-WKC 4T-*/S90/S849	NM-RSC 4T-*/S90/S849 NM-WSC 4T-*/S90/S849	TPU Grey, 3x22 AWG, 80 °C, 5.2 mm OD	1. BN 2. N/C 3. BU 4. BK
NM-WKC.. 	NM-RKC 4.4T-*/S849 NM-WKC 4.4T-*/S849	NM-RSC 4.4T-*/S849 NM-WSC 4.4T-*/S849	PVC Grey, 4x22 AWG, 80 °C, 5.2 mm OD	Male
	NM-RKC 4.4T-*/S90/S849 NM-WKC 4.4T-*/S90/S849	NM-RSC 4.4T-*/S90/S849 NM-WSC 4.4T-*/S90/S849	TPU Grey, 4x22 AWG, 80 °C, 5.2 mm OD	1. BN 2. WH 3. BU 4. BK
NM-RSC.. 	NM-RKC 4.5T-*/S849 NM-WKC 4.5T-*/S849	NM-RSC 4.5T-*/S849 NM-WSC 4.5T-*/S849	PVC Grey, 5x22 AWG, 80 °C, 5.2 mm OD	Female
	NM-RKC 4.5T-*/S90/S849 NM-WKC 4.5T-*/S90/S849	NM-RSC 4.5T-*/S90/S849 NM-WSC 4.5T-*/S90/S849	TPU Grey, 5x22 AWG, 80 °C, 5.2 mm OD	1. BN 2. WH 3. BU 4. BK 5. GY
NM-WSC.. 	NM-RKC 4.5T-*/S849 NM-WKC 4.5T-*/S849	NM-RSC 4.5T-*/S849 NM-WSC 4.5T-*/S849	PVC Grey, 5x22 AWG, 80 °C, 5.2 mm OD	Male
	NM-RKC 4.5T-*/S90/S849 NM-WKC 4.5T-*/S90/S849	NM-RSC 4.5T-*/S90/S849 NM-WSC 4.5T-*/S90/S849	TPU Grey, 5x22 AWG, 80 °C, 5.2 mm OD	1. BN 2. WH 3. BU 4. BK 5. GY

We reserve the right to make technical alterations without prior notice.

Cordsets

* Length in meters. Standard cable lengths are 2, 5, and 10 meters. Consult factory for other lengths. Standard coupling nut material is nickel-plated brass/nylon combination.

4 and 5-Wire S12 Quick-Connect™ Cordsets

- Straight and Right Angle Female Connectors
- IEC IP 67 Protection
- 250 V, 4 A
- Nylon Coupling Nut



Connector Style	Female Part Number	Male Part Number	Features	Pinout
<p>RKC..</p>	RKC 4.4Q-*/S849 WKC 4.4Q-*/S849	RSC 4.4Q-*/S849 WSC 4.4Q-*/S849	ITC/PLTC PVC Grey, 4x22 AWG, 105 °C, 5.3 mm OD, Cable #RF50516-*M, Quick-Connect coupling	<p>Female</p>
<p>WKC..</p>				<p>Male</p>
<p>RSC..</p>	RKC 4.5Q-*/S849 WKC 4.5Q-*/S849	RSC 4.5Q-*/S849 WSC 4.5Q-*/S849	ITC/PLTC PVC Grey, 5x22 AWG, 105 °C, 5.7 mm OD, Cable #RF50543-*M, Quick-Connect coupling	<p>Female</p>
<p>WSC..</p>				<p>Male</p>

We reserve the right to make technical alterations without prior notice.

* Length in meters. Standard cable lengths are 2, 4, 6, 8 and 10 meters. Consult factory for other lengths.

Receptacle Selection Guide

We reserve the right to make technical alterations without prior notice.

Mounting Style	Image	Panel Thread Types	Page
Front Mount		PG 9	D46
		1/4-18 NPT	D49
		1/2-14 NPSM	D52
		1/2-14 NPT	D54
		M20	D57
		PG 16	D59
		PG 13.5	D60
		PG 9 w/Rotating Coupling	D61
		1/4-18 w/Solder Cups	D62
		PG 9 w/Solder Cups	D63
PG 9 Reverse Key	D77		
Rear Mount		PG 9 w/Leads	D66
		PG 9 w/Solder Cups	D68
		PG 9 Reverse Key	D79
		Back Panel Mount	D81
PCB Mount		PG 9 w/PCB Pins	D70
		PG 9 PCB w/Header Pins	D73
		Circuit Board Mounted	D75

2, 4 and 5-Wire Receptacles, Front Mount, PG 9 Threads

- NEMA 1, 3, 4, 6P
- IEC IP68 Protection
- 250 V, 4 A



Housing Style	Female Part Number	Male Part Number	Features	Pinout
<p>FK(N) ..*</p> <p>Typical panel cutout is 15.2 mm</p>	FK 4.2-*	FS 4.2-*	2x22 AWG, 105 °C, mates with 2-pin cordsets	1. N/C 2. N/C 3. BN 4. BU
	FK 4.21-*	FS 4.21-*	2x22 AWG, 105 °C, mates with 2-pin cordsets	1. BN 2. BU 3. N/C 4. N/C
	FK 4.22-*	FS 4.22-*	2x22 AWG, 105 °C, mates with 2-pin cordsets	1. BN 2. N/C 3. BU 4. N/C
	FK 4.4-*	FS 4.4-*	4x22 AWG, 105 °C, mates with 4-pin cordsets	1. BN 2. WH 3. BU 4. BK
	FK 4.4-*/S613	FS 4.4-*/S613	4x18 AWG, 105 °C, mates with 4-pin cordsets	1. BN 2. WH 3. BU 4. BK
	FK 4.4-*/S621	FS 4.4-*/S621	4x18 AWG, 105 °C, mates with 4-pin cordsets	1. GY1 2. GY2 3. GY3 4. GY4
	FK 4.5-*	FS 4.5-*	5x22 AWG, 105 °C, mates with 5-pin cordsets	1. BN 2. WH 3. BU 4. BK 5. GY
<p>FS(N) ..*</p> <p>Typical panel cutout is 15.2 mm</p>	FK 4.5-*/S627	FS 4.5-*/S627	5x20 AWG, 105 °C, mates with 5-pin cordsets	
	FK 4.5-*/S653	FS 4.5-*/S653	4x22 AWG, Drain, 105 °C, 5.1 mm OD, mates with 5-pin cordsets, 4 conductors PVC foil shielded with drain wire to pin 5	1. BN 2. WH 3. BU 4. BK 5. Drain
	FKN 5-*	FSN 5-*	5x22 AWG, 105 °C	1. GN 2. WH 3. OG 4. BK 5. RD

We reserve the right to make technical alterations without prior notice.

* Length in meters. Standard Lead length is 0.5 meters. Consult factory for other lengths. Standard housing material is nickel plated brass "FS.."; "FSV.." indicates stainless steel. To specify PVC jacketed cable, add "/S717" to the end of the part number.

6 and 8-Wire Receptacles, Front Mount, PG 9 Threads

- NEMA 1, 3, 4, 6P
- IEC IP68 Protection



We reserve the right to make technical alterations without prior notice.

Connector Style	Female Part Number	Male Part Number	Features	Pinout
<p>FK ..*</p> <p>Typical panel cutout is 15.2 mm</p>	FK 4.6-*	FS 4.6-*	6x22 AWG, 105 °C, 250 V, 4 A mates with 6-pin cordsets	<p>Female</p> <p>Male</p>
	FK 6-*	FS 6-*	6x24 AWG, 105 °C, 60 VAC/75 VDC, 2 A mates with 6-pin cordsets	<p>Female</p> <p>Male</p>
<p>FS ..*</p> <p>Typical panel cutout is 15.2 mm</p>	FK 8-*	FS 8-*	8x24 AWG, 105 °C, 60 VAC/75 VDC, 2 A mates with 8-pin cordsets	<p>Female</p>
	FK 8.6-*	FS 8.6-*	6x24 AWG, 105 °C, 60 VAC/75 VDC, 2 A mates with 8-pin cordsets	<p>Male</p>

* Length in meters. Standard lead length is 0.5 meters. Consult factory for other lengths. Standard housing material is nickel plated brass "FS.."; "FSV.." indicates stainless steel. To specify PVC jacketed cable, add "/S717" to the end of the part number.

Receptacles

10 and 12-Wire Receptacles, Front Mount, PG 9 Threads

- NEMA 1, 3, 4, 6P
- IEC IP68 Protection
- 60 VAC/75 VDC, 2 A



Connector Style	Female Part Number	Male Part Number	Features	Pinout
<p>FK ..*</p> <p>Typical panel cutout is 15.2 mm</p>	FK 10-*	FS 10-*	10x24 AWG, 105 °C, mates with 10-pin cordsets	<p>Female</p> <p>Male</p>
<p>FS ..*</p> <p>Typical panel cutout is 15.2 mm</p>	FK 12-*	FS 12-*	12x24 AWG, 105 °C, mates with 12-pin cordsets	<p>Female</p> <p>Male</p>

We reserve the right to make technical alterations without prior notice.

* Length in meters. Standard lead length is 0.5 meters. Consult factory for other lengths. Standard housing material is nickel plated brass "FS.."; "FSV.." indicates stainless steel. To specify PVC jacketed cable, add "/S717" to the end of the part number.

4 and 5-Wire Receptacles, Front Mount, 1/4-18 NPT Threads

- NEMA 1, 3, 4, 6P
- IEC IP68 Protection
- 250 V, 4 A



Housing Style	Female Part Number	Male Part Number	Features	Pinout
<p>FK..*/18.25</p> <p>Typical panel cutout is 14.3 mm</p>	FK 4.4-*/18.25	FS 4.4-*/18.25	4x22 AWG, 105 °C, mates with 4-pin cordsets	<p>Female</p>
	FK 4.4-*/18.25/S613	FS 4.4-*/18.25/S613	4x18 AWG, 105 °C, mates with 4-pin cordsets	<p>Male</p>
	FK 4.4-*/18.25/S621	FS 4.4-*/18.25/S621	4x18 AWG, 105 °C, mates with 4-pin cordsets	<p>1. BN 2. WH 3. BU 4. BK</p>
	FK 4.5-*/18.25	FS 4.5-*/18.25	5x22 AWG, 105 °C, mates with 5-pin Cordsets	<p>1. GY1 2. GY2 3. GY3 4. GY4</p>
	FK 4.5-*/18.25/S627	FS 4.5-*/18.25/S627	5x20 AWG, 105 °C, mates with 5-pin cordsets	<p>1. BN 2. WH 3. BU 4. BK 5. GY</p>
	FK 4.5-*/18.25/S653	FS 4.5-*/18.25/S653	4x22 AWG, Drain, 105 °C, 5.1 mm OD, mates with 5-pin cordsets, 4 conductors PVC foil shielded with drain wire to pin 5	<p>1. BN 2. WH 3. BU 4. BK 5. Drain</p>
<p>FS..18.25</p> <p>Typical panel cutout is 14.3 mm</p>	FK 4.5-*/18.25/S621	FS 4.5-*/18.25/S621	5x18 AWG, 105 °C, mates with 5-pin cordsets	<p>Female</p>
				<p>Male</p>

We reserve the right to make technical alterations without prior notice.

Receptacles

* Length in meters. Standard lead length is 0.5 meters. Consult factory for other lengths. Standard housing material is nickel plated brass "FS.."; "FSV.." indicates stainless steel. To specify PVC jacketed cable, add "/S717" to the end of the part number.

6 and 8-Wire Receptacles, Front Mount, 1/4-18 NPT Threads

- NEMA 1, 3, 4, 6P
- IEC IP68 Protection



Housing Style	Female Part Number	Male Part Number	Features	Pinout
<p>FK..*/18.25</p> <p>Typical panel cutout is 14.3 mm</p>	FK 4.6-*/18.25	FS 4.6-*/18.25	6x22 AWG, 105 °C, 250 V, 2 A, mates with 6-pin cordsets	<p>Female</p> <p>Male</p>
	FK 6-*/18.25	FS 6-*/18.25	6x24 AWG, 105 °C, 60 VAC/75 VDC, 2 A, mates with 6-pin cordsets	<p>Female</p> <p>Male</p>
	FK 8-*/18.25	FS 8-*/18.25	8x24 AWG, 105 °C, 60 VAC/75 VDC, 2 A, mates with 8-pin cordsets	<p>Female</p>
	FK 8-*/18.25/S1505	FS 8-*/18.25/S1505	8x26 AWG, 105 °C, 60 VAC/75 VDC, 2 A, mates with 8-pin cordsets	<p>Female</p>
	FK 8.6-*/18.25	FS 8.6-*/18.25	6x24 AWG, 105 °C, 60 VAC/75 VDC, 2 A, mates with 8-pin cordsets	<p>Male</p>

We reserve the right to make technical alterations without prior notice.

* Length in meters. Standard lead length is 0.5 meters. Consult factory for other lengths. Standard housing material is nickel plated brass "FS.."; "FSV.." indicates stainless steel. To specify PVC jacketed cable, add "/S717" to the end of the part number.

10 and 12-Wire Receptacles, Front Mount, 1/4-18 NPT Threads

- NEMA 1, 3, 4, 6P
- IEC IP68 Protection
- 60 VAC/75 VDC, 2 A



Housing Style	Female Part Number	Male Part Number	Features	Pinout
<p>FK ..*/18.25</p> <p>Typical panel cutout is 14.3 mm</p>	FK 10-*/18.25	FS 10-*/18.25	10x24 AWG, 105 °C, mates with 10-pin cordsets	<p>Female</p> <p>Male</p>
<p>FS ..18.25</p> <p>Typical panel cutout is 14.3 mm</p>	FK 12-*/18.25	FS 12-*/18.25	12x24 AWG, 105 °C, mates with 12-pin cordsets	<p>Female</p> <p>Male</p>

We reserve the right to make technical alterations without prior notice.

* Length in meters. Standard lead length is 0.5 meters. Consult factory for other lengths. Standard housing material is nickel plated brass "FS.."; "FSV.." indicates stainless steel. To specify PVC jacketed cable, add "/S717" to the end of the part number.

Receptacles

- NEMA 1, 3, 4, 6P
- IEC IP68 Protection



Housing Style	Female Part Number	Male Part Number	Features	Pinout
<p>FK ..14.5</p> <p>Typical panel cutout is 21 mm</p>	FK 4.4-*/14.5	FS 4.4-*/14.5	4x22 AWG, 105 °C, 250 V, 4 A, mates with 4-pin cordsets	1. BN 2. WH 3. BU 4. BK
	FK 4.4-*/14.5/S613	FS 4.4-*/14.5/S613	4x18 AWG, 105 °C, 250 V, 4 A, mates with 4-pin cordsets	1. BN 2. WH 3. BU 4. BK
	FK 4.4-*/14.5/S621	FS 4.4-*/14.5/S621	4x18 AWG, 105 °C, 250 V, 4 A, mates with 4-pin cordsets	1. GY1 2. GY2 3. GY3 4. GY4
	FK 4.5-*/14.5	FS 4.5-*/14.5	5x22 AWG, 105 °C, 250 V, 4 A, mates with 5-pin cordsets	1. BN 2. WH 3. BU 4. BK 5. GY
	FK 4.6-*/14.5	FS 4.6-*/14.5	6x22 AWG, 105 °C, 250 V, 4 A, mates with 6-pin cordsets	1. BN 2. WH 3. BU 4. BK 5. GY 6. PK
	FK 6-*/14.5	FS 6-*/14.5	6x24 AWG, 105 °C, 60 VAC/75 VDC, 2 A, mates with 6-pin cordsets	1. BN 2. WH 3. BU 4. BK 5. GY 6. PK
<p>FS .. 14.5</p> <p>Typical panel cutout is 21 mm</p>				

We reserve the right to make technical alterations without prior notice.

* Length in meters. Standard cable length is 0.5 meters. Consult factory for other lengths. Standard housing material is nickel plated brass "FS."; "FSV." indicates stainless steel. To specify PVC jacketed cable, add "/S717" to the end of the part number.

8, 10 and 12-Wire Receptacles, Front Mount, 1/2-14 NPSM Threads

- NEMA 1, 3, 4, 6P
- IEC IP68 Protection
- 60 VAC/75 VDC, 2 A



We reserve the right to make technical alterations without prior notice.

Housing Style	Female Part Number	Male Part Number	Features	Pinout
<p>FK ..14.5</p> <p>Typical panel cutout is 21 mm</p>	FK 8-*/14.5	FS 8-*/14.5	8x24 AWG, 105 °C, mates with 8-pin cordsets, CSA Approved	<p>1. WH 2. BN 3. GN 4. YE 5. GY 6. PK 7. BU 8. RD</p> <p>Female</p> <p>Male</p>
	FK 8.6-*/14.5	FS 8.6-*/14.5	6x24 AWG, 105 °C, mates with 8-pin cordsets, CSA Approved	<p>1. WH 2. GN 3. YE 4. GY 5. BN 6. N/C 7. BU 8. N/C</p> <p>Female</p> <p>Male</p>
	FK 10-*/14.5	FS 10-*/14.5	10x24 AWG, 105 °C, mates with 10-pin cordsets	<p>1. WH 2. BN 3. GN 4. YE 5. GY 6. PK 7. BU 8. RD 9. OG 10. TN</p> <p>Female</p> <p>Male</p>
	FK 12-*/14.5	FS 12-*/14.5	12x24 AWG, 105 °C, mates with 12-pin cordsets	<p>1. WH 2. BN 3. GN 4. YE 5. GY 6. PK 7. BU 8. RD 9. OG 10. TN 11. BK 12. VT</p> <p>Female</p> <p>Male</p>

* Length in meters. Standard lead length is 0.5 meters. Consult factory for other lengths. Standard housing material is nickel plated brass "FS.."; "FSV.." indicates stainless steel. To specify PVC jacketed cable, add "/S717" to the end of the part number.

Receptacles

2 and 4-Wire Receptacles, Front Mount, 1/2-14 NPT Threads

- NEMA 1, 3, 4, 6P
- IEC IP68 Protection
- 250 V, 4 A



Housing Style	Female Part Number	Male Part Number	Features	Pinout
<p>FK .. 14.5/NPT</p> <p>Typical panel cutout is 22.5 mm</p>	FK 4.2-*/14.5/NPT	FS 4.2-*/14.5/NPT	2x22 AWG, 105 °C, mates with 2-pin cordsets	<p>Female</p>
	FK 4.22-*/14.5/NPT	FS 4.22-*/14.5/NPT	2x22 AWG, 105 °C, mates with 2-pin cordsets	<p>1. BN 2. N/C 3. BU 4. N/C</p>
<p>FS .. 14.5/NPT</p> <p>Typical panel cutout is 22.5 mm</p>	FK 4.4-*/14.5/NPT	FS 4.4-*/14.5/NPT	4x22 AWG, 105 °C, mates with 4-pin cordsets	<p>Male</p>
	FK 4.4-*/14.5/NPT/S613	FS 4.4-*/14.5/NPT/S613	4x18 AWG, 105 °C, mates with 4-pin cordsets	<p>1. BN 2. WH 3. BU 4. BK</p>

* Length in meters. Standard lead length is 0.5 meters. Consult factory for other lengths. Standard housing material is nickel plated brass "FS.."; "FSV.." indicates stainless steel. To specify PVC jacketed cable, add "/S717" to the end of the part number.

We reserve the right to make technical alterations without prior notice.

5 and 6-Wire Receptacles, Front Mount, 1/2-14 NPT Threads

- NEMA 1, 3, 4, 6P
- IEC IP68 Protection



Housing Style	Female Part Number	Male Part Number	Features	Pinout
<p>FK ..14.5/NPT</p> <p>Typical panel cutout is 22.5 mm</p>	FK 4.5-*/14.5/NPT	FS 4.5-*/14.5/NPT	5x22 AWG, 105 °C, 250 V, 4 A, mates with 5-pin cordsets	<p>Female</p> <p>Male</p>
	FK 4.6-*/14.5/NPT	FS 4.6-*/14.5/NPT	6x22 AWG, 105 °C, 250 V, 4 A, mates with 6-pin cordsets	<p>Female</p> <p>Male</p>
<p>FS .. 14.5/NPT</p> <p>Typical panel cutout is 22.5 mm</p>	FK 6-*/14.5/NPT	FS 6-*/14.5/NPT	6x24 AWG, 105 °C, 60 VAC/75 VDC, 2 A, mates with 6-pin cordsets	<p>Female</p> <p>Male</p>

We reserve the right to make technical alterations without prior notice.

Receptacles

* Length in meters. Standard lead length is 0.5 meters. Consult factory for other lengths. Standard housing material is nickel plated brass "FS.."; "FSV.." indicates stainless steel. To specify PVC jacketed cable, add "/S717" to the end of the part number.

- NEMA 1, 3, 4, 6P
- IEC IP68 Protection
- 60 VAC/75 VDC, 2 A



Housing Style	Female Part Number	Male Part Number	Features	Pinout
<p>FK ..14.5/NPT</p> <p>Typical panel cutout is 22.5 mm</p>	FK 8-*/14.5/NPT	FS 8-*/14.5/NPT	8x24 AWG, 105 °C, mates with 8-pin cordsets, CSA Approved	<p>Female</p> <ol style="list-style-type: none"> WH BN GN YE GY PK BU RD
	FK 8.6-*/14.5/NPT	FS 8.6-*/14.5/NPT	6x24 AWG, 105 °C, mates with 8-pin cordsets, CSA Approved	<p>Male</p> <ol style="list-style-type: none"> WH GN YE GY BN N/C BU N/C
<p>FS .. 14.5/NPT</p> <p>Typical panel cutout is 22.5 mm</p>	FK 10-*/14.5/NPT	FS 10-*/14.5/NPT	10x24 AWG, 105 °C, mates with 10-pin cordsets	<p>Female</p> <ol style="list-style-type: none"> WH BN GN YE GY PK BU RD OG TN <p>Male</p> <ol style="list-style-type: none"> WH BN GN YE GY PK BU RD OG TN
	FK 12-*/14.5/NPT	FS 12-*/14.5/NPT	12x24 AWG, 105 °C, mates with 12-pin cordsets	<p>Female</p> <ol style="list-style-type: none"> WH BN GN YE GY PK BU RD OG TN BK VT <p>Male</p> <ol style="list-style-type: none"> WH BN GN YE GY PK BU RD OG TN BK VT

We reserve the right to make technical alterations without prior notice.

* Length in meters. Standard lead length is 0.5 meters. Consult factory for other lengths. Standard housing material is nickel plated brass "FS.."; "FSV.." indicates stainless steel. To specify PVC jacketed cable, add "/S717" to the end of the part number.

4, 5 and 6-Wire Receptacles, Front Mount, M20 Threads

- NEMA 1, 3, 4, 6P
- IEC IP68 Protection



Housing Style	Female Part Number	Male Part Number	Features	Pinout
<p>FK ../M20</p> <p>Typical panel cutout is 20.4 mm</p>	FK 4.4-*/M20	FS 4.4-*/M20	4x22 AWG, 105 °C, 250 V, 4 A, mates with 4-pin cordsets	<p>Female</p> <p>Male</p> <p>1. BN 2. WH 3. BU 4. BK</p>
	FK 4.5-*/M20	FS 4.5-*/M20	5x22 AWG, 105 °C, 250 V, 4 A, mates with 5-pin cordsets	<p>Female</p> <p>Male</p> <p>1. BN 2. WH 3. BU 4. BK 5. GY</p>
<p>FS ../M20</p> <p>Typical panel cutout is 20.4 mm</p>	FK 6-*/M20	FS 6-*/M20	6x24 AWG, 105 °C, 60 VAC/75 VDC, 2 A, mates with 6-pin cordsets	<p>Female</p> <p>Male</p> <p>1. BN 2. WH 3. BU 4. BK 5. GY 6. PK</p>

We reserve the right to make technical alterations without prior notice.

Receptacles

* Length in meters. Standard lead length is 0.5 meters. Consult factory for other lengths. Standard housing material is nickel plated brass "FS.."; "FSV.." indicates stainless steel. To specify PVC jacketed cable, add "/S717" to the end of the part number.

8, 10 and 12-Wire Receptacles, Front Mount, M20 Threads

- NEMA 1, 3, 4, 6P
- IEC IP68 Protection
- 60 VAC/75 VDC, 2 A



Housing Style	Female Part Number	Male Part Number	Features	Pinout
<p>FK .. / M20</p> <p>Typical panel cutout is 20.4 mm</p>	FK 8-*/M20	FS 8-*/M20	8x24 AWG, 105 °C, mates with 8-pin cordsets, CSA Approved	<ol style="list-style-type: none"> 1. WH 2. BN 3. GN 4. YE 5. GY 6. PK 7. BU 8. RD <p>Female</p>
	FK 8.6-*/M20	FS 8.6-*/M20	6x24 AWG, 105 °C, mates with 8-pin cordsets, CSA Approved	<ol style="list-style-type: none"> 1. WH 2. GN 3. YE 4. GY 5. BN 6. N/C 7. BU 8. N/C <p>Male</p>
	FK 10-*/M20	FS 10-*/M20	10x24 AWG, 105 °C, mates with 10-pin cordsets	<ol style="list-style-type: none"> 1. WH 2. BN 3. GN 4. YE 5. GY 6. PK 7. BU 8. RD 9. OG 10. TN <p>Female</p> <p>Male</p>
	FK 12-*/M20	FS 12-*/M20	12x24 AWG, 105 °C, mates with 12-pin cordsets	<ol style="list-style-type: none"> 1. WH 2. BN 3. GN 4. YE 5. GY 6. PK 7. BU 8. RD 9. OG 10. TN 11. BK 12. VT <p>Female</p> <p>Male</p>



We reserve the right to make technical alterations without prior notice.

* Length in meters. Standard lead length is 0.5 meters. Consult factory for other lengths. Standard housing material is nickel plated brass "FS.."; "FSV.." indicates stainless steel. To specify PVC jacketed cable, add "/S717" to the end of the part number.

4, 5, 6, 8, 10 and 12-Wire Receptacles, Front Mount, PG 16 Threads

- NEMA 1, 3, 4, 6P
- IEC IP68 Protection

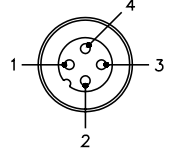
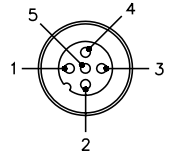
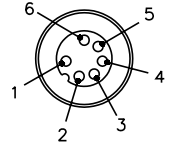
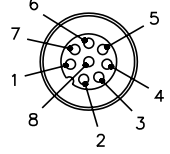
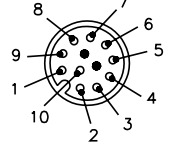
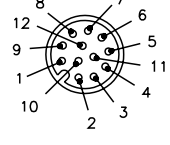

Connector Style	Male Part Number	Features	Pinout
	FS 4.4-*/PG16	4x22 AWG, 105 °C, 250 V, 4 A, mates with 4-pin cordset, CSA Approved	1. BN 2. WH 3. BU 4. BK 
	FS 4.5-*/PG16	5x22 AWG, 105 °C, 250 V, 4 A, mates with 5-pin cordset, CSA Approved	1. BN 2. WH 3. BU 4. BK 5. GY 
	FS 6-*/PG16	6x24 AWG, 105 °C, 60 VAC/75 VDC, 2 A, mates with 6-pin cordset, CSA Approved	1. BN 2. WH 3. BU 4. BK 5. GY 6. PK 
	FS 8-*/PG16	8x24 AWG, 105 °C, 60 VAC/75 VDC, 2 A, mates with 8-pin cordset, CSA Approved	1. WH 2. BN 3. GN 4. YE 5. GY 6. PK 7. BU 8. RD 
	FS 8.6-*/PG16	6x24 AWG, 105 °C, 60 VAC/75 VDC, 2 A, mates with 8-pin cordset, CSA Approved	1. WH 2. GN 3. YE 4. GY 5. BN 6. N/C 7. BU 8. N/C 
	FS 10-*/PG16	10x24 AWG, 105 °C, 60 VAC/75 VDC, 2 A, mates with 10-pin cordset	1. WH 2. BN 3. GN 4. YE 5. GY 6. PK 7. BU 8. RD 9. OG 10. TN 
	FS 12-*/PG16	12x24 AWG, 105 °C, 60 VAC/75 VDC, 2 A, mates with 12-pin cordset	1. WH 2. BN 3. GN 4. YE 5. GY 6. PK 7. BU 8. RD 9. OG 10. TN 11. BK 12. VT 

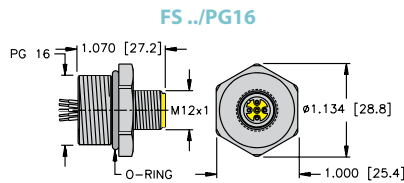

Typical panel cutout is 22.5 mm

We reserve the right to make technical alterations without prior notice.

Receptacles

4 and 5-Wire Receptacles, Front Mount, PG 13.5 Threads

- NEMA 1, 3, 4, 6P
- IEC IP68 Protection



Housing Style	Male Part Number	Features	Pinout
<p>FS .. / PG13.5</p> <p>Typical panel cutout is 20.4 mm</p>	FS 4.4-*/PG13.5	4x22 AWG, 105 °C, 250 V, 4 A, mates with 4-pin cordsets, PG 13.5 Threads, CSA Approved	1. BN 2. WH 3. BU 4. BK
	FS 4.5-*/PG13.5	5x22 AWG, 105 °C, 250 V, 4 A, mates with 5-pin cordsets, PG 13.5 Threads, CSA Approved	1. BN 2. WH 3. BU 4. BK 5. GY
	FS 6-*/PG13.5	6x22 AWG, 105 °C, 60 VAC/75 VDC, 2 A, mates with 4-pin cordsets, PG 13.5 Threads, CSA Approved	1. BN 2. WH 3. BU 4. BK 5. GY 6. PK
	FS 8-*/PG13.5	8x22 AWG, 105 °C, 60 VAC/75 VDC, 2 A, mates with 4-pin cordsets, PG 13.5 Threads, CSA Approved	1. WH 2. BN 3. GN 4. YE 5. GY 6. PK 7. BU 8. RD
	FS 10-*/PG13.5	10x22 AWG, 105 °C, 60 VAC/75 VDC, 2 A, mates with 4-pin cordsets, PG 13.5 Threads	1. WH 2. BN 3. GN 4. YE 5. GY 6. PK 7. BU 8. RD 9. OG 10. TN
	FS 12-*/PG13.5	12x22 AWG, 105 °C, 60 VAC/75 VDC, 2 A, mates with 4-pin cordsets, PG 13.5 Threads	1. WH 2. BN 3. GN 4. YE 5. GY 6. PK 7. BU 8. RD 9. OG 10. TN 11. BK 12. VT

We reserve the right to make technical alterations without prior notice.

4, 5, 6 and 8-Wire Receptacles, with Rotating Coupling Nut

- NEMA 1, 3, 4, 6P
- IEC IP68 Protection



Housing Style	Female Part Number	Features	Pinout
<p>FKM ..*</p> <p>Typical panel cutout is 15.2 mm</p>	FKM 4.4-*	4x22 AWG, 105 °C, 250 V, 4 A, mates with 4-pin cordsets	1. BN 2. WH 3. BU 4. BK
	FKM 4.5-*	5x22 AWG, 105 °C, 250 V, 4 A, mates with 5-pin cordsets	1. BN 2. WH 3. BU 4. BK 5. GY
	FKM 4.5-*/S653	4x22 AWG, Drain, 105 °C, 250 V, 4 A, 5.1 mm OD, mates with 5-pin cordsets, 4 conductors PVC foil Shielded with Drain Wire to pin 5	1. BN 2. WH 3. BU 4. BK 5. Drain
	FKM 4.6-*	6x22 AWG, 105 °C, 250 V, 2 A, mates with 6-pin cordsets	1. BN 2. WH 3. BU 4. BK 5. GY 6. PK
	FKM 6-*	6x24 AWG, 105 °C, 60 VAC/75 VDC, 2 A, mates with 6-pin cordsets	1. BN 2. WH 3. BU 4. BK 5. GY 6. PK
	FKM 8-*	8x24 AWG, 105 °C, 60 VAC/75 VDC, 2 A, mates with 8-pin cordsets	1. WH 2. BN 3. GN 4. YE 5. GY 6. PK 7. BU 8. RD

We reserve the right to make technical alterations without prior notice.

Receptacles

* Length in meters. Standard lead length is 0.5 meters. Consult factory for other lengths.
 Standard housing material is nickel plated brass.
 To specify PVC jacketed cable, add "/S717" to the end of the part number.

4 and 5-Pin Receptacles, Front Mount, Leads and Solder Cups

- NEMA 1, 3, 4, 6P
- IEC IP68 Protection
- 250 V, 4 A



Housing Style	Female Part Number	Male Part Number	Features	Pinout
<p>FK ..18.25</p> <p>Typical panel cutout is 14.3 mm</p>	<p>FK 4.4/18.25</p>	<p>FS 4.4/18.25</p>	<p>105 °C, Solder Cup, mates with 4-pin cordsets, 1/4-18 NPT Threads</p>	<p>Female</p>
<p>FS ..18.25</p> <p>Typical panel cutout is 14.3 mm</p>				<p>Male</p>

* Length in meters. Standard lead length is 0.5 meters. Consult factory for other lengths. Standard housing material is nickel plated brass "FS.."; "FSV.." indicates stainless steel. To specify PVC jacketed cable, add "/S717" to the end of the part number.

We reserve the right to make technical alterations without prior notice.

4 and 5-Pin Receptacles, Front Mount, Leads and Solder Cups

- NEMA 1, 3, 4, 6P
- IEC IP68 Protection
- 250 V, 4 A



We reserve the right to make technical alterations without prior notice.

Housing Style	Female Part Number	Male Part Number	Features	Pinout
<p>FK..</p> <p>Typical panel cutout is 15.2 mm</p>	FK 4.4	FS 4.4	105 °C, Solder Cup, mates with 4-pin cordsets, PG 9 Threads	<p>Female</p> <p>Male</p>
<p>FS..</p> <p>Typical panel cutout is 15.2 mm</p>	FK 4.5	FS 4.5	105 °C, Solder Cup, mates with 5-pin cordsets, PG 9 Threads	<p>Female</p> <p>Male</p>
<p>FS../14.5</p> <p>Typical panel cutout is 21 mm</p>		FS 4.4/14.5	105 °C, Solder Cup, mates with 4-pin cordsets, 1/2-14 NPSM Threads	<p>Male</p>
		FS 4.5/14.5	105 °C, Solder Cup, mates with 5-pin cordsets, 1/2-14 NPSM Threads	<p>Male</p>

Receptacles

4, 5 and 6-Wire Receptacles, with Front Lock Nut

- NEMA 1, 3, 4, 6P
- IEC IP68 Protection
- 250 V, 4 A (4 & 5 pole)
- 60 VAC/75 VDC, 2 A (6 pole)



Housing Style	Female Part Number	Male Part Number	Features	Pinout
<p>FKD 4.4*</p> <p>Typical panel cutout is 15.2 mm</p>	FKD 4.4*	FSD 4.4*	4x22 AWG, 105 °C, mates with 4-pin cordsets	<p>Female</p> <p>Male</p>
	FKD 4.5*	FSD 4.5*	5x22 AWG, 105 °C, mates with 5-pin cordsets	<p>Female</p>
	FKD 4.5*/S653	FSD 4.5*/S653	4x22 AWG, Drain, 105 °C, 5.1 mm OD, mates with 5-pin cordsets, 4 Conductors PVC foil Shielded with Drain Wire to pin 5	<p>Male</p>
<p>FSD 6-*</p> <p>Typical panel cutout is 15.2 mm</p>	FKD 6-*	FSD 6-*	6x24 AWG, 105 °C, mates with 6-pin cordsets	<p>Female</p> <p>Male</p>

We reserve the right to make technical alterations without prior notice.

* Length in meters. Standard lead length is 0.5 meters. Consult factory for other lengths.
 Standard housing material is nickel plated brass "FSD."; "FSDV." indicates 316 stainless steel.
 To specify PVC jacketed cable, add "/S717" to the end of the part number.

8, 10 and 12-Wire Receptacles, with Front Lock Nut

- NEMA 1, 3, 4, 6P
- IEC IP68 Protection
- 60 VAC/75 VDC, 2 A



We reserve the right to make technical alterations without prior notice.

Housing Style	Female Part Number	Male Part Number	Features	Pinout
<p>FKD 8-*</p> <p>Typical panel cutout is 15.2 mm</p>	FKD 8-*	FSD 8-*	8x24 AWG, 105 °C, mates with 8-pin cordsets, CSA Approved	<p>Female</p> <p>Male</p>
<p>FKD 10-*</p> <p>Typical panel cutout is 15.2 mm</p>	FKD 10-*	FSD 10-*	10x24 AWG, 105 °C, mates with 10-pin cordsets	<p>Female</p> <p>Male</p>
<p>FKD 12-*</p> <p>Typical panel cutout is 15.2 mm</p>	FKD 12-*	FSD 12-*	12x24 AWG, 105 °C, mates with 12-pin cordsets	<p>Female</p> <p>Male</p>

* Length in meters. Standard lead length is 0.5 meters. Consult factory for other lengths. Standard housing material is nickel plated brass "FSD.."; "FSDV.." indicates stainless steel. To specify PVC jacketed cable, add "/S717" to the end of the part number.

Receptacles

4 and 5-Wire Receptacles, Rear Mount with Leads

- NEMA 1, 3, 4, 6P
- IEC IP68 Protection
- 250 V, 4 A (4 & 5 pole)
- 60 VAC/75 VDC, 2A (6 pole)



Housing Style	Female Part Number	Male Part Number	Features	Pinout	
<p>FKFD ..</p> <p>Typical panel cutout is 15.3 x 14 mm</p>	FKFD 4.4-*	FSFD 4.4-*	4x22 AWG, 105 °C, mates with 4-pin cordsets	<p>Female</p> <p>Male</p>	
	FKFD 4.4-*/S621	FSFD 4.4-*/S621	4x18 AWG, 105 °C, mates with 4-pin cordsets	<p>1. GY1</p> <p>2. GY2</p> <p>3. GY3</p> <p>4. GY4</p>	
	FKFD 4.5-*	FSFD 4.5-*	5x22 AWG, 105 °C, mates with 5-pin cordsets	<p>1. BN</p> <p>2. WH</p> <p>3. BU</p> <p>4. BK</p> <p>5. GY</p>	<p>Female</p> <p>Male</p>
	FKFD 4.5-*/S653	FSFD 4.5-*/S653	4x22 AWG, Drain, 105 °C, 5.1 mm OD, mates with 5-pin cordsets, 4 Conductors PVC Foil Shielded with Drain Wire to pin 5	<p>1. BN</p> <p>2. WH</p> <p>3. BU</p> <p>4. BK</p> <p>5. Drain</p>	
	<p>FSFD ..*</p> <p>Typical panel cutout is 15.3 x 14 mm</p>	FKFD 6-*	FSFD 6-*	6x24 AWG, 105 °C, mates with 6-pin cordsets	<p>Female</p> <p>Male</p>
				<p>1. BN</p> <p>2. WH</p> <p>3. BU</p> <p>4. BK</p> <p>5. GY</p> <p>6. PK</p>	

We reserve the right to make technical alterations without prior notice.

* Length in meters. Standard lead length is 0.5 meters. Consult factory for other lengths.
 Standard housing material is nickel plated brass "FSFD.."; "FSFDV.." indicates stainless steel.
 To specify PVC jacketed cable, add "/S717" to the end of the part number.

6, 8, 10 and 12-Wire Receptacles, Rear Mount with Leads

- NEMA 1, 3, 4, 6P
- IEC IP68 Protection
- 60 VAC/75 VDC, 2 A



Housing Style	Female Part Number	Male Part Number	Features	Pinout
<p>FKFD ..</p> <p>Typical panel cutout is 15.3 x 14 mm</p>	FKFD 8-*	FSFD 8-*	8x24 AWG, 105 °C, mates with 8-pin cordsets, CSA Approved	<p>Female</p> <p>Male</p>
	FKFD 8-*/S1505	FSFD 8-*/S1505	8x26 AWG, 105 °C, mates with 8-pin cordsets	<p>1. WH 2. BN 3. GN 4. YE 5. GY 6. PK 7. BU 8. RD</p>
	FKFD 10-*	FSFD 10-*	10x24 AWG, 105 °C, mates with 10-pin cordsets	<p>Female</p> <p>Male</p>
	FKFD 12-*	FSFD 12-*	12x24 AWG, 105 °C, mates with 12-pin cordsets	<p>1. WH 2. BN 3. GN 4. YE 5. GY 6. PK 7. BU 8. RD 9. OG 10. TN 11. BK 12. VT</p>
<p>FSFD ..*</p> <p>Typical panel cutout is 15.3 x 14 mm</p>				<p>Female</p> <p>Male</p>

We reserve the right to make technical alterations without prior notice.

Receptacles

* Length in meters. Standard lead length is 0.5 meters. Consult factory for other lengths. Standard housing material is nickel plated brass "FSFD.."; "FSFDV.." indicates stainless steel. To specify PVC jacketed cable, add "/S717" to the end of the part number.

4 and 5-Pin Receptacles, Rear Mount with Solder Cups

- NEMA 1, 3, 4, 6P
- IEC IP68 Protection
- 250 V, 4 A (4 & 5 pole)
- 60 VAC/75 VDC, 2 A (6 pole)



Housing Style	Female Part Number	Male Part Number	Features	Pinout
<p>FKFDL ..</p> <p>Typical panel cutout is 15.3 x 14 mm</p>	FKFDL 4.4	FSFDL 4.4	Accepts 18 AWG max Leads, 105 °C, mates with 4-pin cordsets	<p>Female</p> <p>Male</p>
<p>FKFDL ..</p> <p>Typical panel cutout is 15.3 x 14 mm</p>	FKFDL 4.5	FSFDL 4.5	Accepts 18 AWG max Leads, 105 °C, mates with 5-pin cordsets	<p>Female</p> <p>Male</p>
<p>FSFDL ..*</p> <p>Typical panel cutout is 15.3 x 14 mm</p>	FKFDL 6	FSFDL 6	Accepts 22 AWG max Leads, 105 °C, mates with 6-pin cordsets	<p>Female</p> <p>Male</p>

We reserve the right to make technical alterations without prior notice.

Standard housing material is nickel plated brass "FSFDL.."; "FSFDLV.." indicates stainless steel.

8, 10 and 12-Pin Receptacles, Rear Mount with Solder Cups

- NEMA 1, 3, 4, 6P
- IEC IP68 Protection
- 60 VAC/75 VDC, 2 A



Housing Style	Female Part Number	Male Part Number	Features	Pinout
<p>FKFDL ..</p> <p>Typical panel cutout is 15.3 x 14 mm</p>	<p>FKFDL 8</p>	<p>FSFDL 8</p>	<p>Accepts 22 AWG Max Leads, 105 °C, Mates with 8-pin Cordsets</p>	<p>Female</p>
<p>FSFDL ..-*</p> <p>Typical panel cutout is 15.3 x 14 mm</p>				<p>Male</p>

Standard housing material is nickel plated brass "FSFDL.."; "FSFDLV.." indicates stainless steel.

We reserve the right to make technical alterations without prior notice.

Receptacles

4, 5, 6 and 8-Pin Receptacles, Rear Mount with PCB Pins

- NEMA 1, 3, 4, 6P
- IEC IP68 Protection
- 250 V, 4 A (4 & 5 pole)
- 60 VAC/75 VDC (6 & 8 pole)



Housing Style	Female Part Number	Male Part Number	Features	Pinout
<p>FKFD ..</p> <p>Typical panel cutout is 15.3 x 14 mm</p>	FKFD 4.4	FSFD 4.4	105 °C, mates with 4-pin cordsets	<p>Female</p> <p>Male</p>
	FKFD 4.5	FSFD 4.5	105 °C, mates with 5-pin cordsets	<p>Female</p> <p>Male</p>
	FKFD 6	FSFD 6	105 °C, mates with 6-pin cordsets	<p>Female</p> <p>Male</p>
	FKFD 8	FSFD 8	105 °C, mates with 8-pin cordsets	<p>Female</p> <p>Male</p>
<p>FSFD ..</p> <p>Typical panel cutout is 15.3 x 14 mm</p>				

We reserve the right to make technical alterations without prior notice.

Standard housing material is nickel plated brass "FSFD.."; "FSFDV.." indicates stainless steel.

4 and 5-Pin Receptacles, Rear Mount with PCB Pins

- NEMA 1, 3, 4, 6P
- IEC IP68 Protection
- 250 V, 4 A



Housing Style	Female Part Number	Male Part Number	Features	Pinout
<p>FKFDK ..</p> <p>Typical panel cutout is 15.3 x 14 mm</p>		FSFDK 4.4	Nickel plated brass, 105 °C, mates with 4-pin cordsets, short pins	<p>Male</p>
<p>FSFDK ..</p> <p>Typical panel cutout is 15.3 x 14 mm</p>	FKFDK 4.5	FSFDK 4.5	Nickel plated brass, 105 °C, mates with 5-pin cordsets, short pins	<p>Female</p> <p>Male</p>

Standard housing material is nickel plated brass "FSFDK.."; "FSFDKV.." indicates stainless steel.

We reserve the right to make technical alterations without prior notice.

Receptacles

4, 5, 6 and 8-Pin Receptacles, Rear Mount with PCB Pins

- Male Receptacles
- NEMA 1, 3, 4, 6P
- IEC IP68 Protection
- 250 V, 4 A (4 & 5 pole)
- 60 VAC/75 VDC, 2 A (6 & 8 pole)



Housing Style	Male Part Number	Features	Pinout
	WFS 4.4-PCB	105 °C, mates with 4-pin cordsets, nickel plated brass housing material	<p>Male</p>
	WFS 4.5-PCB	105 °C, mates with 5-pin cordsets, nickel plated brass housing material	<p>Male</p>
	WFS 6-PCB	105 °C, mates with 6-pin cordsets, nickel plated brass housing material	<p>Male</p>
	WFS 8-PCB	105 °C, mates with 8-pin cordsets, nickel plated brass housing material	<p>Male</p>

We reserve the right to make technical alterations without prior notice.

WFS PCB Layout

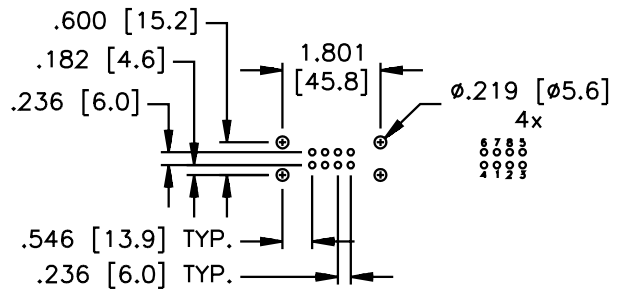
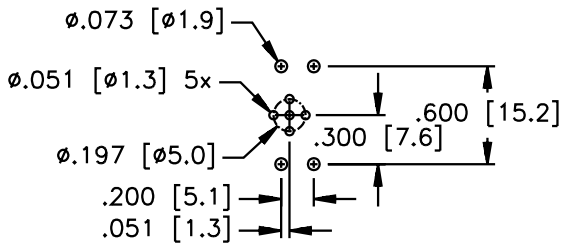

5, 6 and 8-Pin Receptacles, Rear Mount PCB with Header Pins

- NEMA 1, 3, 4, 6 P
- IEC IP 67 Protection
- 250 V, 4 A (5 pole)
- 60 VAC/75 VDC (6 & 8 pole)



Housing Style	Female Part Number	Male Part Number	Features	Pinout
<p>WKFD ..PCBH</p> <p>Typical panel cutout is 15.3 x 14 mm</p>	WFKD 4.5-PCBH	WFSD 4.5-PCBH	105 °C, mates with 5-pin cordsets, nickel plated brass housing material	<p>Female</p> <p>Male</p>
<p>WFKD 6-PCBH</p>	WFKD 6-PCBH	WFSD 6-PCBH	105 °C, mates with 6-pin cordsets, nickel plated brass housing material	<p>Female</p> <p>Male</p>
<p>WFSD ..PCBH</p> <p>Typical panel cutout is 15.3 x 14 mm</p>	WFKD 8-PCBH	WFSD 8-PCBH	105 °C, mates with 8-pin cordsets, nickel plated brass housing material	<p>Female</p> <p>Male</p>

We reserve the right to make technical alterations without prior notice.

Receptacles

10 and 12-Pin Receptacles, Rear Mount PCB with Header Pins

- NEMA 1, 3, 4, 6P
- IEC IP 67 Protection
- 60 VAC/75 VDC, 2 A



Housing Style	Female Part Number	Male Part Number	Features	Pinout
<p>WKFD ..PCBH</p> <p>Typical panel cutout is 15.3 x 14 mm</p>	WFKD 10-PCBH	WFSD 10-PCBH	105 °C, mates with 10-pin cordsets, nickel plated brass housing material	<p>Female</p> <p>Male</p>
<p>WFSD ..PCBH</p> <p>Typical panel cutout is 15.3 x 14 mm</p>	WFKD 12-PCBH	WFSD 12-PCBH	105 °C, mates with 12-pin cordsets, nickel plated brass housing material	<p>Female</p> <p>Male</p>

We reserve the right to make technical alterations without prior notice.

4 and 5-Pin Circuit Board Mounted Receptacles

- NEMA 1, 3, 4, 6P
- IEC IP68 Protection
- 250 V, 4 A



We reserve the right to make technical alterations without prior notice.

Housing Style	Female Part Number	Male Part Number	Features	Pinout
<p>FK .. PCB</p>	FK 4.5-PCB	FS 4.5-PCB	105 °C, mates with 5-pin cordsets, nickel plated brass housing material	<p>Female</p> <p>Male</p>
<p>FS ..-PCB</p>	FKFDH 4.4	FSFDH 4.4	105 °C, mates with 4-pin cordsets, separate housing and contact carrier, nickel plated brass housing material	<p>Female</p> <p>Male</p>
<p>FKFDH ..</p> <p>Typical panel cutout is 15.3 x 14 mm</p>	FKFDH 4.5	FSFDH 4.5	105 °C, mates with 5-pin cordsets, separate housing and contact carrier, nickel plated brass housing material	<p>Female</p> <p>Male</p>
<p>FSFDH ..</p> <p>Typical panel cutout is 15.3 x 14 mm</p>	FKFDH 4.5	FSFDH 4.5	105 °C, mates with 5-pin cordsets, separate housing and contact carrier, nickel plated brass housing material	<p>Female</p> <p>Male</p>

FKFDH - Detail

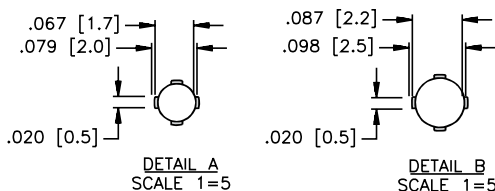

FSFDH - Detail

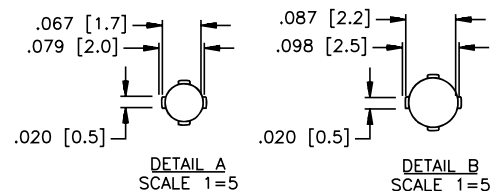

Receptacles

4 and 5-Pin Circuit Board Mounted Receptacles

- NEMA 1, 3, 4, 6P
- IEC IP68 Protection
- 250 V, 4 A



Housing Style	Female Part Number	Male Part Number	Features	Pinout
<p>WFKFDH ..</p> <p>Typical panel cutout is 12 mm</p>	WFKFDH 4.4	WFSFDH 4.4	105 °C, mates with 4-pin cordsets, separate housing and contact carrier, right angle, nickel plated brass housing material	<p>Female</p> <p>Male</p>
<p>FKFDHOW ..</p> <p>Typical panel cutout is 12 mm</p>	WFKFDH 4.5	WFSFDH 4.5	105 °C, mates with 5-pin cordsets, separate housing and contact carrier, right angle, nickel plated brass housing material	<p>Female</p> <p>Male</p>
<p>WFSFDH ..</p> <p>Typical panel cutout is 12 mm</p>	FKFDHOW 4.5		105 °C, mates with 5-pin cordsets, separate housing and contact carrier, reverse key, nickel plated brass housing material	<p>Female</p>

We reserve the right to make technical alterations without prior notice.

5-Wire Receptacles, Front Mount, Reverse Key

- NEMA 1, 3, 4, 6P
- IEC IP68 Protection
- 250 V, 4 A



We reserve the right to make technical alterations without prior notice.

Housing Style	Female Part Number	Male Part Number	Features	Pinout
<p>FKW ..*</p> <p>Typical panel cutout is 15.2 mm</p>	FKW 4.5-*	FSW 4.5-*	4x22, 1x20 AWG, 105 °C, mates with 5-pin Reverse Key Cordset	<ol style="list-style-type: none"> 1. BN 2. WH 3. BU 4. BK 5. GN/YE
<p>FSW ..</p> <p>Typical panel cutout is 15.2 mm</p>	FKW 4.5-*/S653	FSW 4.5-*/S653	4x22 AWG, Drain 105 °C, 5.1 mm OD, mates with 5-pin Reverse Key Cordset, 4 Conductors PVC Foil Shielded with Drain Wire to pin 5	<ol style="list-style-type: none"> 1. BN 2. WH 3. BU 4. BK 5. Drain
<p>FKW ..14.5</p> <p>Typical panel cutout is 21 mm</p>	FKW 4.5-*/14.5	FSW 4.5-*/14.5	4x22, 1x20 AWG 105 °C, mates with 5-pin Reverse Key Cordset	<ol style="list-style-type: none"> 1. BN 2. WH 3. BU 4. BK 5. GN/YE
<p>FSW ..14.5</p> <p>Typical panel cutout is 21 mm</p>	FKW 4.5*/14.5/NPT	FSW 4.5-*/14.5/NPT	4x22, 1x20 AWG 105 °C, mates with 5-pin Reverse Key Cordset	<ol style="list-style-type: none"> 1. BN 2. WH 3. BU 4. BK 5. GN/YE
<p>FSW ..14.5/NPT</p> <p>Typical panel cutout is 22.5 mm</p>				

* Length in meters. Standard lead length is 0.5 meters. Consult factory for other lengths. Standard housing material is nickel plated brass "FSW.."; "FSWV.." indicates stainless steel. To specify PVC jacketed cable, add "/S717" to the end of the part number.

Receptacles

5-Wire Receptacles, Front Mount, Reverse Key

- NEMA 1, 3, 4, 6P
- IEC IP68 Protection
- 250 V, 4A



Housing Style	Female Part Number	Male Part Number	Features	Pinout
<p>FKMW ..</p> <p>Typical panel cutout is 15.2 mm</p>	FKMW 4.5-*		4x22, 1x20 AWG, 105 °C, mates with 5-pin Reverse Key Cordset, PG 9 threads, rotating coupling nut	<p>Female</p>
<p>FKDW ..</p> <p>Typical panel cutout is 15.2 mm</p>				
<p>FSDW ..</p> <p>Typical panel cutout is 15.2 mm</p>	FKDW 4.5-*	FSDW 4.5-*	4x22, 1x20 AWG AWM PVC, 105 °C, mates with 5-pin Reverse Key Cordset, PG 9 threads	<p>Male</p>

* Length in meters. Standard lead length is 0.5 meters. Consult factory for other lengths. Standard housing material is nickel plated brass "FSW.."; "FSWV.." indicates stainless steel. To specify PVC jacketed cable, add "/S717" to the end of the part number.

We reserve the right to make technical alterations without prior notice.

5-Wire Receptacles, Rear Mount, Reverse Key

- NEMA 1, 3, 4, 6P
- IEC IP68 Protection
- 250 V, 4 A



Housing Style	Female Part Number	Male Part Number	Features	Pinout
<p>FKFDW ..</p> <p>Typical panel cutout is 15.3 x 14.0 mm</p>	FKFDW 4.5-*	FSFDW 4.5-*	5x22 AWG, 105 °C, mates with 5-pin Reverse Key Cordset, leads, UL Listed, CSA Approved	<p>Female</p>
<p>FSFDW ..</p> <p>Typical panel cutout is 15.3 x 14.0 mm</p>				
<p>FKFDLW ..</p> <p>Typical panel cutout is 15.3 x 14.0 mm</p>	FKFDLW 4.5	FSFDLW 4.5	Accepts 20 AWG Max Leads, 105 °C, mates with 5-pin Reverse Key Cordset, solder cup	<p>Male</p>
<p>FSFDLW ..</p> <p>Typical panel cutout is 15.3 x 14.0 mm</p>				

We reserve the right to make technical alterations without prior notice.

* Length in meters. Standard lead length is 0.5 meters. Consult factory for other lengths. Standard housing material is nickel plated brass. To specify PVC jacketed cable, add "/S717" to the end of the part number.

5-Pin Receptacles, Rear Mount, Reverse Key, With PCB Pins

- NEMA 1, 3, 4, 6P
- IEC IP68 Protection
- 250 V, 4 A



Housing Style	Female Part Number	Male Part Number	Features	Pinout
<p>FKFDW ..</p> <p>Typical panel cutout is 15.3 x 14.0 mm</p>	FKFDW 4.5	FSFDW 4.5	105 °C, mates with 5-pin Reverse Key Cordsets, PCB pins	<p>Female</p>
<p>FSFDW ..</p> <p>Typical panel cutout is 15.3 x 14.0 mm</p>				<p>Male</p>
<p>FSFDKW ..</p> <p>Typical panel cutout is 15.3 x 14.0 mm</p>	FKFDKW 4.5	FSFDKW 4.5	105 °C, mates with 5-pin Reverse Key Cordsets, short PCB pins	<p>Male</p>
<p>FKFDKW ..</p> <p>Typical panel cutout is 15.3 x 14.0 mm</p>				<p>Female</p>

We reserve the right to make technical alterations without prior notice.

* Length in meters. Standard lead length is 0.5 meters. Consult factory for other lengths.
 Standard housing material is nickel plated brass.
 To specify PVC jacketed cable, add "/5717" to the end of the part number.

4 and 5-Wire Receptacles, Back Panel Mount

- NEMA 1, 3, 4, 6P
- IEC IP68 Protection
- 250 V, 4 A



Housing Style	Female Part Number	Features	Pinout
	FKP 4.4-*	4x18 AWG, 105 °C, mates with 4-pin cordsets	1. BN 2. WH 3. BU 4. BK
	FKP 4.4-*/S621	4x18 AWG, 105 °C, mates with 4-pin cordsets	1. GY1 2. GY2 3. GY3 4. GY4
	FKP 4.5-*	5x18 AWG, 105 °C, mates with 5-pin cordsets	1. BN 2. WH 3. BU 4. BK 5. GY
	FKP 4.5-*/S621	5x18 AWG, 105 °C, mates with 5-pin cordsets	1. GY1 2. GY2 3. GY3 4. GY4 5. GY5

Receptacles

We reserve the right to make technical alterations without prior notice.

* Length in meters. Standard lead length is 0.5 meters. Consult factory for other lengths. Standard material is nickel plated brass. To specify PVC jacketed cable, add "/S717" to the end of the part number.

- Female to Male Receptacles
- NEMA 1, 3, 4, 6P
- IEC IP68 Protection



Housing Style	Part Number	Features	Pinout
	FK FS 4.4/M12	4-conductor, 80 °C, 150 V, 4 A, mates with 4-pin cordsets	
	FK FS 4.5/M12	5-conductor, 80 °C, 150 V, 4 A, mates with 5-pin cordsets	
	FKW FSW 4.5/M12	5-conductor, 80 °C, 150 V, 4 A, mates with 5-pin Reverse Key cordsets	
	FK FS 4.6/M12	6-conductor, 80 °C, 36 V, 1.5 A, mates with 6-pin cordsets	
	FK FS 6/M12	6-conductor, 80 °C, 36 V, 1.5 A, mates with 6-pin cordsets	
	FK FS 8/M12	8-conductor, 80 °C, 36 V, 1.5 A, mates with 8-pin cordsets	

We reserve the right to make technical alterations without prior notice.

Standard housing material is nickel plated brass "FK FS.."; "FKV FSV.." indicates stainless steel.

4 and 5-Pin Field Wireable Connectors, Standard Key

- IEC IP67 Protection



We reserve the right to make technical alterations without prior notice.

Housing Style	Female Part Number	Male Part Number	Features	Pinout
<p>B 81..</p>	<p>B 8141-0 B 8241-0</p>	<p>BS 8141-0 BS 8241-0</p>	<p>PBT, Black, PG 7 cable gland, accepts 4-6 mm cable diameter, screw terminals, accepts up to 18 AWG conductors, 85 °C, 250 V, 4 A, mates with standard key 4-pin cordsets and receptacles</p>	<p>Female</p>
<p>B 82..</p>	<p>B 8141-0/PG 9 B 8241-0/PG 9</p>	<p>BS 8141-0/PG 9 BS 8241-0/PG 9</p>	<p>PBT, Black, PG 9 cable gland, accepts 6-8 mm cable diameter, screw terminals, accepts up to 18 AWG conductors, 85 °C, 250 V, 4 A, mates with standard key 4-pin cordsets and receptacles</p>	<p>Male</p>
<p>BS 81..</p>	<p>B 8151-0/PG 9 B 8251-0/PG 9</p>	<p>BS 8151-0/PG 9 BS 8251-0/PG 9</p>	<p>PBT, Black, PG 9 cable gland, accepts 4-8 mm cable diameter, screw terminals, accepts up to 18 AWG conductors, 85 °C, 60 V, 4 A, mates with standard key 5-pin cordsets and receptacles</p>	<p>Female</p>
<p>BS 82..</p>	<p>BM 8151-0/PG 9</p>		<p>PBT, Black, PG 9 cable gland, accepts 6-8 mm cable diameter, screw terminals, accepts up to 18 AWG conductors, metal coupling nut, 85 °C, 60 V, 4 A, mates with standard key 5-pin cordsets and receptacles</p>	<p>Male</p>

Field Wireables

• IEC IP67 Protection



Housing Style	Female Part Number	Male Part Number	Features	Pinout
<p>B 81..</p>		BS 8157-0/PG 9	PBT, Black, PG 9 cable gland accepts 6-8 mm cable diameter, spring clamp accepts up to 20 AWG conductors, 85 °C, 125 V, 4 A, Mates with standard key 5-pin cordsets and receptacles, spring clamp	<p>Male</p>
	BWS 8141-0	BSWS 8141-0 BSWS 8241-0	PBT, Black, PG 9 cable gland accepts 6-8 mm cable diameter, screw terminals accepts up to 18 AWG conductors, 85 °C, 250 V, 4 A, mates with reverse key 4-pin cordsets and receptacles	<p>Female</p> <p>Male</p>
<p>B 82..</p>				<p>Female</p> <p>Male</p>
<p>BWS 8151-0 BWS 8251-0</p>	BWS 8151-0 BWS 8251-0	BSWS 8151-0 BSWS 8251-0	PBT, Black, PG 9 cable gland accepts 6-8 mm cable diameter, screw terminals accepts up to 18 AWG conductors, 85 °C, 60 V, 4 A, mates with reverse key 5-pin cordsets and receptacles	<p>Female</p> <p>Male</p>
<p>BS 81..</p>	B 8181-0 B 8281-0	BS 8181-0 BS 8281-0	Nylon, Black, PG 9 cable gland accepts 6-8 mm cable diameter, screw terminals accepts up to 18 AWG conductors, 85 °C, 60 VAC/75 VDC, 2 A, mates with standard key 8-pin cordsets and receptacles	<p>Female</p> <p>Male</p>
<p>BS 82..</p>	B 81121-0/PG 9	BS 81121-0/PG 9	Nylon, Black, PG 9 cable gland accepts 4-8 mm cable diameter, solder cups accept up to 24 AWG conductors, 85 °C, 30 V, 1 A, mates with standard key 12-pin cordsets and receptacles	<p>Female</p> <p>Male</p>

We reserve the right to make technical alterations without prior notice.

4 and 5-Pin Field Wireable Connectors, Standard with Labels

- IEC IP67 Protection



Housing Style	Female Part Number	Male Part Number	Features	Pinout
<p>B 81..</p>	<p>B 8141-0/LABEL B 8241-0/LABEL</p>	<p>BS 8141-0/LABEL BS 8241-0/LABEL</p>	<p>PBT, Black, PG 7 cable gland accepts 4-6 mm cable diameter, screw terminals accepts up to 18 AWG conductors, 85 °C, 250 V, 4 A, mates with standard key 4-pin cordsets and receptacles, color coded & numbered pins</p>	<p>Female</p>
<p>B 82..</p>	<p>B 8141-0/PG9/LABEL B 8241-0/PG9/LABEL</p>	<p>BS 8141-0/PG9/LABEL BS 8241-0/PG9/LABEL</p>	<p>PBT, Black, PG 9 cable gland, accepts 6-8 mm cable diameter, screw terminals accepts up to 18 AWG conductors, 85 °C, 250 V, 4 A, mates with standard key 4-pin cordsets and receptacles, color coded & numbered pins</p>	<p>Male</p>
<p>BS 81..</p>	<p>B 8151-0/PG9/LABEL B 8251-0/PG9/LABEL</p>	<p>BS 8151-0/PG9/LABEL BS 8251-0/PG9/LABEL</p>	<p>PBT, Black, PG 9 cable gland accepts 4-8 mm cable diameter, screw terminals accepts up to 18 AWG conductors, 85 °C, 60 V, 4 A, mates with standard key 5-pin cordsets and receptacles, color coded & numbered pins</p>	<p>Female</p>
<p>BS 82..</p>	<p>B 8151-0/PG9/LABEL B 8251-0/PG9/LABEL</p>	<p>BS 8151-0/PG9/LABEL BS 8251-0/PG9/LABEL</p>	<p>PBT, Black, PG 9 cable gland accepts 4-8 mm cable diameter, screw terminals accepts up to 18 AWG conductors, 85 °C, 60 V, 4 A, mates with standard key 5-pin cordsets and receptacles, color coded & numbered pins</p>	<p>Male</p>

We reserve the right to make technical alterations without prior notice.

Field Wireables

4-Pin Field Wireable Connectors with LEDs

- IEC IP67 Protection



Housing Style	Female Part Number	Male Part Number	Features	Pinout
<p>B 81..</p>	B 8141-P7X2-0	BS 8141-P7X2-0	PBT, Clear, accepts 4-6 mm cable diameter accepts 20-26 AWG (conductor diameter 1-1.6 mm), Insulation Avoidance, 85 °C, 10-30 V, 4 A, mates with standard key 4-pin cordsets and receptacles, 2 LEDs - Signal and Power	<p>Female</p>
<p>BS 81..</p>				<p>Male</p>

Wiring Diagram

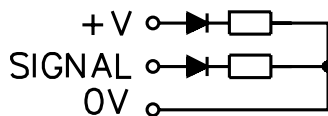

We reserve the right to make technical alterations without prior notice.

4-Pin Field Wireable Connectors, IDC

- Insulation Displacement Technology
- No Conductor Stripping Required
- IEC IP67 Protection



We reserve the right to make technical alterations without prior notice.

Housing Style	Female Part Number	Male Part Number	Features	Pinout
<p>B 81..</p> <p>BS 81..</p>	B 8146-0	BS 8146-0	Nickel Plated Brass, accepts 4-5 mm cable diameter, IDC accepts 26 to 22 AWG conductors, 85 °C, 32 V, 4 A, mates with standard key 4-pin cordsets and receptacles	<p>Female</p>
<p>B 83..</p> <p>BS 83..</p>	B 8346-0	BS 8346-0	Nickel Plated Brass, accepts 5.5-8.5 mm cable diameter, IDC accepts up to 18 AWG conductors, 85 °C, 50 V, 6 A, mates with standard key 4-pin cordsets and receptacles	
<p>B 82..</p> <p>BS 82..</p>	B 8246-0	BS 8246-0	Nickel Plated Brass, accepts 4-5 mm cable diameter, IDC accepts 26 to 22 AWG conductors, 85 °C, 32 V, 4 A, mates with standard key 4-pin cordsets and receptacles	<p>Male</p>

Field Wireables

4, 5 and 8-Pin Field Wireable Connectors, Shielded, Screw Terminals

- Screw Terminals
- No Soldering Required
- IEC IP67 Protection



Housing Style	Female Part Number	Male Part Number	Features	Pinout
<p>CMB 81..</p>	CMB 8141-0 CMB 8241-0	CMBS 8141-0 CMBS 8241-0	Nickel Plated Brass, PG 9 cable gland, accepts 6-8 mm cable diameter, screw terminal accepts up to 18 AWG conductors, 85 °C, 250 V, 4 A, Metal, fully shielded Mates with standard key 4-pin cordsets and receptacles	<p>Female</p> <p>Male</p>
<p>CMB 82..</p>	CMB 8151-0 CMB 8251-0	CMB 8151-0 CMB 8251-0	Nickel Plated Brass, PG 9 cable gland, accepts 6-8 mm cable diameter, screw terminal, accepts up to 18 AWG conductors, 85 °C, 60 V, 4 A, metal, fully shielded Mates with standard key 5-pin cordsets and receptacles	<p>Female</p> <p>Male</p>
<p>CMBS 81..</p>				<p>Female</p> <p>Male</p>
<p>CMBS 82..</p>	CMB 8181-0	CMBS 8181-0	Nickel Plated Brass, PG 9 cable gland accepts 6-8 mm cable diameter, screw terminal accepts up to 18 AWG conductors, 85 °C, 60 V, 2 A, metal, fully shielded, mates with standard key 8-pin cordsets and receptacles	<p>Female</p> <p>Male</p>

We reserve the right to make technical alterations without prior notice.

5-Pin Field Wireable Connectors, Reverse Key

- IEC IP67 Protection



Housing Style	Female Part Number	Male Part Number	Features	Pinout
<p>BMWS 81..</p>	BMWS 8151-0/9	BMSWS 8151-0/9	Nickel Plated Brass, PG 9 cable gland, accepts 6-8 mm cable diameter, screw terminal, accepts up to 18 AWG conductors, 85 °C, 60 V, 4 A, Metal, fully shielded, mates with reverse key 5-pin cordsets and receptacles	<p>Female</p>
<p>BMWS 82..</p>				
<p>BMSWS 81..</p>	BMWS 8251-0/9	BMSWS 8251-0/9	Nickel Plated Brass, PG 9 cable gland, accepts 6-8 mm cable diameter, screw terminal, accepts up to 18 AWG conductors, 85 °C, 60 V, 4 A, metal, fully shielded, mates with reverse key 5-pin cordsets and receptacles	<p>Male</p>
<p>BMSWS 82..</p>				

We reserve the right to make technical alterations without prior notice.

Field Wireables

5-Pin Field Wireable Splitter

- 2 into 1, Parallel, AND Function etc.
- IEC IP67 Protection



Housing Style	Female Part Number	Male Part Number	Features	Pinout
<p>DBK(S)..</p>	DBK 8151-0	DBS 8151-0	Nylon, Black, Nylon coupling nut, accepts 2x3 mm or 2x5 mm cable diameters, screw terminals, accepts up to 18 AWG conductors, 85 °C, 125 V, 4 A, splitter, accepts 2 cables and converts to 1	<p>Female</p>
<p>DBK(S)M..</p>	DBKM 8151-0	DBSM 8151-0	Nylon, nickel plated brass, coupling nut, accepts 4-5 mm cable diameters, screw terminals, accepts up to 18 AWG, conductors, 85 °C, 125 V, 4 A, splitter, accepts 2 cables and converts to 1, straight male connector	<p>Male</p>

We reserve the right to make technical alterations without prior notice.

Conduit Adapters

- Attaches to standard Crouse-Hinds 3/4" Form 8 Conduit Bodies for transition to 5-wire Eurofast® Connectors
- Gasket and 8-32 x 1/2 Mounting Screws included
- IP67 Protection (only when all receptacles are mated or covered with plugs)
- Terminal Strips accept up to 12 AWG Wires



Housing Style	Part Number	Features	Pinout	Wiring Diagram
	CA-1/FK 4.5	Nylon housing, 80 °C, 250 V, 4 A, attaches to standard conduit body for transition to 5-wire Eurofast connector		
	CA-2/FK 4.5			

We reserve the right to make technical alterations without prior notice.

Field Wireables

Standard receptacle housing material is nickel plated brass "CA-1(2)/FK 4.5"; "CA-1(2)/FKV 4.5" indicates stainless steel.

- Attaches to standard Crouse-Hinds 3/4" Form 8 Conduit Bodies for transition to 5-wire Eurofast Connectors
- Gasket and 8-32 x 1/2 Mounting Screws included
- IP67 Protection (only when all receptacles are mated or covered with plugs)
- Terminal Strips accept up to 12 AWG Wires



Housing Style	Part Number	Features	Pinout	Wiring Diagram
	CA-1/FKW 4.5	Nylon housing, 80 °C, 250 V, 4 A, attaches to standard conduit body for transition to 5-wire Eurofast, reverse key connector		
	CA-2/FKW 4.5			

Standard receptacle housing material is nickel plated brass "CA-1(2)/FKW 4.5"; "CA-1(2)/FKWV 4.5" indicates stainless steel.

We reserve the right to make technical alterations without prior notice.

Adapters

- Converts Eurofast to Minifast®
- Rugged Metal Connector
- IP67 Protection



Housing Style	Part Number	Features	Pinout
	RSM 40-FK 4.4	80 °C, 250 V, 4 A, female Eurofast to male Minifast adapter, 4-pin	
	RSM 50-FK 4.5	80 °C, 250 V, 4 A, female Eurofast to male Minifast adapter, 5-pin	

We reserve the right to make technical alterations without prior notice.

eurofast®

Connector Inserts

- For use in Sensors and Custom Receptacles
- Available with Solder Cups and PCB Pins
- Compatible with standard Eurofast Cordsets



Housing Style	Part Number	Features	Pinout
	EWAS 4.4 (10/BAG)	Nylon or PUR, accepts up to 20 AWG, 250 V, 4 A, up to 4 conductors, DC applications	
	EWAS 4.5 (10/BAG)	Nylon or PUR, accepts up to 20 AWG, 250 V, 4 A, up to 5 conductors, DC applications	
	EWAS 6 (10/BAG)	Nylon or PUR, accepts up to 24 AWG, 30 VAC/36 VDC, 4 A, up to 6 conductors, DC applications	
	EWAS 8 (10/BAG)	Nylon or PUR, accepts up to 24 AWG, 30 VAC/36 VDC, 1.5 A, up to 8 conductors, DC applications	
	EWAK 4 PCB (10/BAG)	Nylon or PUR, 250 V, 4 A, up to 3 conductors, DC applications	
	EWAK 4.4 PCB (10/BAG)	Nylon or PUR, 250 V, 4 A, up to 4 conductors, DC applications	
	EWAK 4.5 PCB (10/BAG)	Nylon or PUR, 250 V, 4 A, up to 5 conductors, DC applications	
	EWASW 4.5 (10/BAG)	Reverse key, nylon or PUR, accepts up to 20 AWG, 250 V, 4 A, up to 5 conductors, DC applications	

We reserve the right to make technical alterations without prior notice.

Closure Caps

We reserve the right to make technical alterations without prior notice.

eurofast®

Drawing	Part Number	Features
	RK-CC	Nickel plated brass, M12x1 threads, 6" lanyard, mates to male cordsets and receptacles
	RKV-CC	Stainless steel, M12x1 threads, 6" lanyard, mates to male cordsets and receptacles
	RS-CC	Nickel plated brass, M12x1 threads, 6" lanyard, mates to female cordsets and receptacles
	RSV-CC	Stainless steel, M12x1 threads, 6" lanyard, mates to female cordsets and receptacles
	FK-CC	Nickel plated brass, M12x1 threads, 6" lanyard with eyelet, mates to male cordsets and receptacles
	FKV-CC	Stainless steel, M12x1 threads, 6" lanyard with eyelet, mates to male cordsets and receptacles
	FS-CC	Nickel plated brass, M12x1 threads, 6" lanyard with eyelet, mates to female cordsets and receptacles
	FSV-CC	Stainless steel, M12x1 threads, 6" lanyard with eyelet, mates to female cordsets and receptacles
	FKK-CC	Plastic, M12x1 threads, 3" lanyard with eyelet, mates to male cordsets and receptacles
	FSK-CC	Plastic, M12x1 threads, 3" lanyard with eyelet, mates to female cordsets and receptacles

Drawing	Part Number	Features
	RKK-CC	Plastic, M12x1 threads, mates to male cordsets and receptacles
	RSK-CC	Plastic, M12x1 threads, mates to female cordsets and receptacles
	RK-MC	Nickel plated brass, M12x1 threads, no lanyard, mates to male cordsets and receptacles
	RKV-MC	Stainless steel, M12x1 threads, no lanyard, mates to male cordsets and receptacles
	RS-MC	Nickel plated brass, M12x1 threads, no lanyard, mates to female cordsets and receptacles
	RSV-MC	Stainless steel, M12x1 threads, no lanyard, mates to female cordsets and receptacles
	VZ3 (8/BAG)	Nylon, mates to VB2 series junction boxes and female cordsets and receptacles

We reserve the right to make technical alterations without prior notice.

Part Number Keys	E2
Cordsets	E4
Receptacles	E8
Field Wireables	E16
Adapters	E17

Features

- 2 to 6 pin
- Up to 4 Amp, 250 Volt rated
- IEC IP67 protection
- NEMA 6P rated
- Low current AC applications



Cordset Part Number key

Part Number Keys are to assist in IDENTIFICATION ONLY. Consult factory for catalog items not identified.

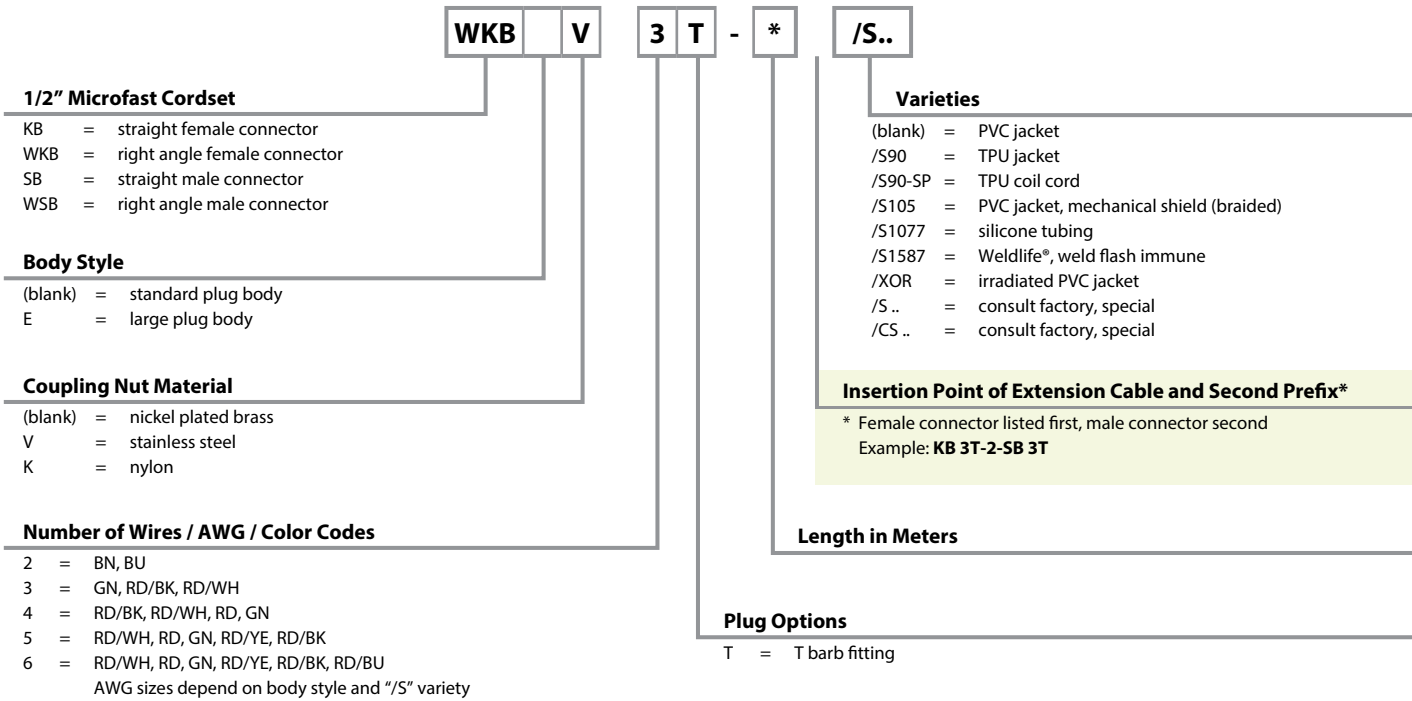

Extension Examples:

Hybrid connector extensions also available. Consult factory.



KB 3 T - 2 SB 3 T



WKB 3 T - 2 SB 3 T

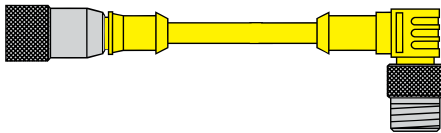

KB 3 T - 2 WSB 3 T

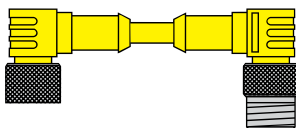

WKB 3 T - 2 WSB 3 T

Cordset Part Number key

Part Number Keys are to assist in IDENTIFICATION ONLY. Consult factory for catalog items not identified.

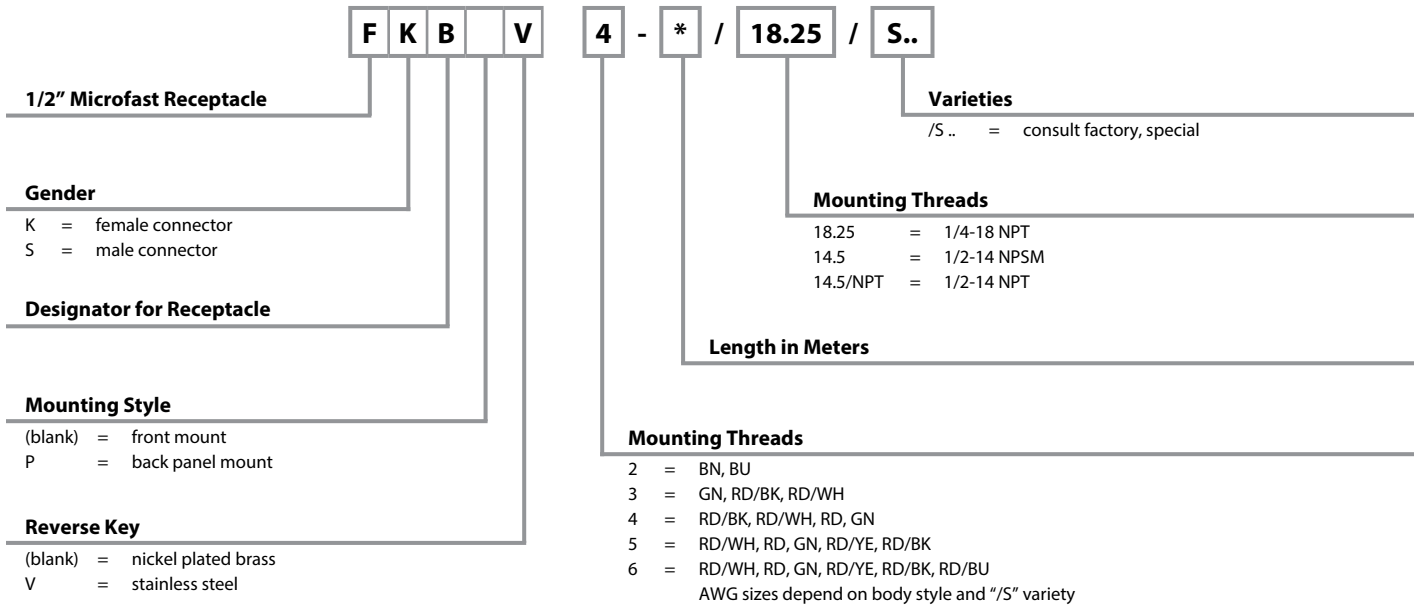

microfast®

Field Wireable Part Number Key

Part Number Keys are to assist in IDENTIFICATION ONLY. Consult factory for catalog items not identified.

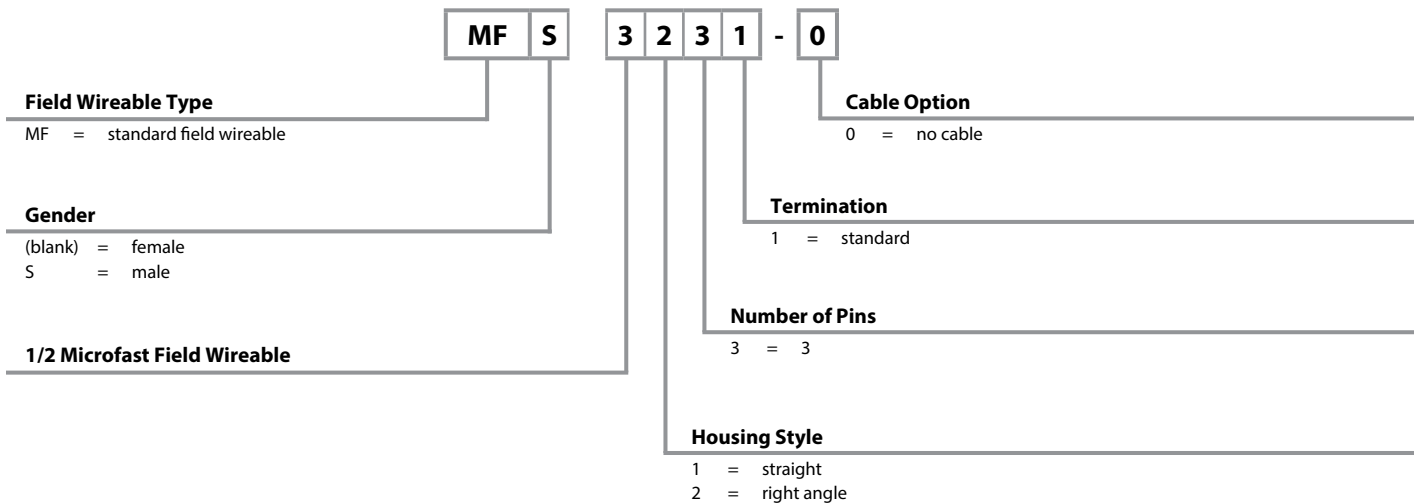

- NEMA 1, 3, 4, 6P
- IEC IP67 Protection
- 250 V, 4 A



Connector Style	Female Part Number	Male Part Number	Features	Pinout
<p>WSB ..**</p>	KB 3T-* WKB 3T-*	SB 3T-* WSB 3T-*	ITC/PLTC PVC Yellow, 3x22 AWG, 105 °C, 5.1 mm OD, Cable #RF50531-*M	<p>Female</p>
<p>WKB ..**</p>	KB 3T-*/S90 WKB 3T-*/S90	SB 3T-*/S90 WSB 3T-*/S90	AWM TPU Yellow, 3x18 AWG, 90 °C, 5.3 mm OD, Cable #RF50547-*M, Cut/Abrasion Immune	
<p>SB ..**</p>	KB 3T-*/S105 WKB 3T-*/S105	SB 3T-*/S105 WSB 3T-*/S105	ITC/PLTC PVC Yellow, 3x22 AWG, 105 °C, 6.2 mm OD, Cable #RF50535-*M, Braided Shield	
<p>S749 ..**</p>	KB 3T-*/S749 WKB 3T-*/S749	SB 3T-*/S749 WSB 3T-*/S749	ITC/PLTC PVC Yellow, 2x22 AWG, 105 °C, 5.1 mm OD, Cable #RF50650-*M, 3-pin with 2 conductors	<p>Male</p>
<p>S1507 ..**</p>	KB 3T-*/S1507 WKB 3T-*/S1507	SB 3T-*/S1507 WSB 3T-*/S1507	AWM TPE Grey, 3x22 AWG 105 °C, 4.8 mm OD, Cable #RF52085-*M, Flexlife-20, High Flex - Over 20 million cycles	

We reserve the right to make technical alterations without prior notice.

* Length in meters. Standard cable lengths are 2, 4, 6, 8 and 10 meters. Consult factory for other lengths.
 ** Standard coupling nut material is nickel plated brass "KB .."; "KBK .." indicates nylon and "KBV .." indicates stainless steel.

4, 5 and 6-Wire Cordsets, Standard Duty

- NEMA 1, 3, 4, 6P
- IEC IP67 Protection
- 250 V, 4 A



We reserve the right to make technical alterations without prior notice.

Connector Style	Female Part Number	Male Part Number	Features	Pinout
<p>KB ..**</p>	KB 4T-* WKB 4T-*	SB 4T-* WSB 4T-*	ITC/PLTC PVC Yellow, 4x22 AWG, 105 °C, 5.3 mm OD, Cable #RF50555-*M, Flexlife®	<p>Female</p>
	KB 4T-*/S90 WKB 4T-*/S90	SB 4T-*/S90 WSB 4T-*/S90	AWM TPU Yellow, 4x22 AWG, 90 °C, 4.7 mm OD, Cable #RF50614-*M, Cut/Abrasion Immune	
<p>WKB ..**</p>	KB 4T-*/S105 WKB 4T-*/S105	SB 4T-*/S105 WSB 4T-*/S105	ITC/PLTC PVC Yellow, 4x22 AWG, 105 °C, 6.2 mm OD, Cable #RF50656-*M, Braided Copper Shield	<p>Male</p>
	KB 4T-*/S727 WKB 4T-*/S727	SB 4T-*/S727 WSB 4T-*/S727	AWM TPU Grey, 4x22 AWG, 90 °C, 5.1 mm OD, Cable #RF50532-*M, Special Conductor Color Code	
<p>SB ..**</p>	KB 5T-* WKB 5T-*	SB 5T-* WSB 5T-*	ITC/PLTC PVC Yellow, 5x22 AWG, 105 °C, 5.7 mm OD, Cable #RF50556-*M, Flexlife	<p>Female</p> <p>Male</p>
	KB 6T-* WKB 6T-*	SB 6T-* WSB 6T-*	ITC/PLTC PVC Yellow, 6x22 AWG, 105 °C, 6.2 mm OD, Cable #RF51003-*M, Flexlife	
<p>WSB ..**</p>	KB 6T-* WKB 6T-*	SB 6T-* WSB 6T-*	ITC/PLTC PVC Yellow, 6x22 AWG, 105 °C, 6.2 mm OD, Cable #RF51003-*M, Flexlife	<p>Female</p> <p>Male</p>

microfast®

* Length in meters. Standard cable lengths are 2, 4, 6, 8 and 10 meters. Consult factory for other lengths.

** Standard coupling nut material is nickel plated brass "KB .."; "KBK .." indicates nylon and "KBV .." indicates stainless steel.

1/2" microfast® Connectivity

2, 3 and 5-Wire Cordsets, Large Plug Body



- NEMA 1, 3, 4, 6P
- IEC IP67 Protection
- 250 V, 4 A



Connector Style	Female Part Number	Male Part Number	Features	Pinout
<p>KBE ..** 1.911 [48.5] 0.551 [14.0] 1/2-20UNF</p>	KBE 2T-* WKBE 2T-*	SBE 2T-* WSBE 2T-*	ITC/PLTC PVC Yellow, 2x18 AWG, 105 °C, 6.2 mm OD, Cable #RF50511-*M, Flexlife®	<p>Female</p> <p>Male</p>
<p>WKBE ..** 1.713 [43.5] 1.260 [32.0] 0.551 [14.0] 1/2-20UNF</p>	KBE 3T-* WKBE 3T-*	SBE 3T-* WSBE 3T-*	ITC/PLTC PVC Yellow, 3x18 AWG, 105 °C, 6.2 mm OD, Cable #RF50520-*M, Flexlife	<p>Female</p> <p>Male</p>
<p>SBE ..** 2.173 [55.2] 0.551 [14.0] 1/2-20UNF</p>	KBE 3T-*/S600 WKBE 3T-*/S600	SBE 3T-*/S600 WSBE 3T-*/S600	SJOOW CPE Yellow, 3x18 AWG, 105 °C, 8.0 mm OD, Cable #RF50658-*M, Weld Flash Immune, Flame Immune	<p>1. GN 2. RD/BK 3. RD/WH</p> <p>Female</p> <p>Male</p>
<p>SBE ..** 2.173 [55.2] 0.551 [14.0] 1/2-20UNF</p>	KBE 5T-* WKBE 5T-*	SBE 5T-* WSBE 5T-*	ITC/PLTC TPE Yellow, 5x18 AWG, 105 °C, 6.2 mm OD, Cable #RF50957-*M, Weldlife, Weld Flash Immune	<p>Female</p> <p>Male</p>
<p>WSBE ..** 1.713 [43.5] 1.574 [40.0] 0.551 [14.0] 1/2-20UNF</p>	KBE 5T-*/S600 WKBE 5T-*/S600	SBE 5T-*/S600 WSBE 5T-*/S600	SJOOW CPE Yellow, 5x18 AWG, 105 °C, 9.4 mm OD, Cable #RF50659-*M, Weld Flash Immune, Flame Immune	<p>1. RD/WH 2. RD/BU 3. GN 4. RD/OG 5. RD/BK</p> <p>Female</p> <p>Male</p>
<p>SBE ..** 1.713 [43.5] 1.574 [40.0] 0.551 [14.0] 1/2-20UNF</p>	KBE 5T-*/S1587 WKBE 5T-*/S1587	SBE 5T-*/S1587 WSBE 5T-*/S1587	ITC/PLTC TPE Yellow, 5x18 AWG, 105 °C, 7.6 mm OD, Cable #RF50958-*M, Weldlife, Weld Flash Immune	<p>Female</p> <p>Male</p>

We reserve the right to make technical alterations without prior notice.

* Length in meters. Standard cable lengths are 2, 4, 6, 8 and 10 meters. Consult factory for other lengths.
 ** Standard coupling nut material is nickel plated brass "KB .."; "KBK .." indicates nylon and "KBV .." indicates stainless steel.

3 and 4-Wire Spiral Cordsets, Standard Duty

- NEMA 1, 3, 4, 6P
- IEC IP67 Protection
- 250 V, 4 A



We reserve the right to make technical alterations without prior notice.

Connector Style	Female Part Number	Male Part Number	Features	Pinout
<p>KB ..SP**</p>	<p>KB 3T-3.3/S90-SP WKB 3T-3.3/S90-SP</p>	<p>SB 3T-3.3/S90-SP WSB 3T-3.3/S90-SP</p>	<p>AWM TPU Yellow, 3x22 AWG, 90 °C, 250 V, 4 A, 5.1 mm OD, for repetitive motion, 3-wire applications</p>	<p>Female</p> <p>1. GN 2. RD/BK 3. RD/WH</p> <p>Male</p>
<p>WKB ..SP**</p>				
<p>SB ..SP**</p>	<p>KB 4T-3.3/S90-SP/S727 WKB 4T-3.3/S90-SP/S727</p>	<p>SB 4T-3.3/S90-SP/S727 WSB 4T-3.3/S90-SP/S727</p>	<p>AWM TPU Grey, 4x22 AWG, 90 °C, 250 V, 4 A, 5.1 mm OD, for repetitive motion, 3-wire AC flow sensor applications</p>	<p>Female</p> <p>1. BN 2. WH 3. BU 4. BK</p> <p>Male</p>
<p>WSB ..SP**</p>				

** Standard coupling nut material is nickel plated brass "KB"(WKB)"; "KBV(WKBV)" indicates stainless steel.

microfast®

Mounting Style	Image	Panel Thread Types	Page
<p>Front Mount</p>		<p><u>1/2-14 NPSM</u> <u>E9</u></p> <p><u>1/2-14 NPT</u> <u>E11</u></p> <p><u>1/4-18 NPT</u> <u>E13</u></p>	
<p>Rear Mount</p>		<p><u>11/16-24 UNEF</u> <u>E15</u></p> <p><u>Bulkhead Feed-thru</u> <u>E15</u></p>	

We reserve the right to make technical alterations without prior notice.

2, 3 and 4-Wire Receptacles, Front Mount, 1/2-14 NPSM Threads

- NEMA 1, 3, 4, 6P
- IEC IP67 Protection
- 250 V, 4 A



Housing Style	Female Part Number	Male Part Number	Features	Pinout
<p>FKB ...</p> <p>Typical panel cutout 22.5 mm</p>	FKB 2-*/14.5	FSB 2-*/14.5	2x18 AWG, 105 °C	<p>Female</p> <p>Male</p> <p>1. BN 2. BU</p>
<p>FSB ...</p> <p>Typical panel cutout 22.5 mm</p>	FKB 3-*/14.5	FSB 3-*/14.5	3x22 AWG, 105 °C	<p>Female</p> <p>Male</p> <p>1. GN 2. RD/BK 3. RD/WH</p>
	FKB 3-*/14.5/S690	FSB 3-*/14.5/S690	3x18 AWG, 105 °C	<p>Male</p>
<p>FSB ...</p> <p>Typical panel cutout 22.5 mm</p>	FKB 4-*/14.5	FSB 4-*/14.5	4x22 AWG, 105 °C	<p>Female</p> <p>Male</p> <p>1. RD/BK 2. RD/WH 3. RD 4. GN</p>

We reserve the right to make technical alterations without prior notice.

microfast®

* Length in meters. Standard lead length is 0.5 meters. Consult factory for other lengths. Standard housing material is nickel plated brass. "FSB...". To specify PVC jacketed cable, add "/S717" to the end of the part number.

- NEMA 1, 3, 4, 6P
- IEC IP67 Protection
- 250 V, 4 A



Housing Style	Female Part Number	Male Part Number	Features	Pinout
<p>FKB ...</p> <p>Typical panel cutout 22.5 mm</p>	FKB 5-*/14.5	FSB 5-*/14.5	5x22 AWG, 105 °C	<p>Female</p> <p>1. RD/WH 2. RD 3. GN 4. RD/YE 5. RD/BK</p> <p>Male</p>
<p>FSB ...</p> <p>Typical panel cutout 22.5 mm</p>	FKB 5-*/14.5/S690	FSB 5-*/14.5/S690	5x18 AWG, 105 °C	<p>Female</p> <p>1. RD/WH 2. RD 3. GN 4. RD/YE 5. RD/BK</p> <p>Male</p>
<p>FSB ...</p> <p>Typical panel cutout 22.5 mm</p>	FKB 6-*/14.5	FSB 6-*/14.5	6x22 AWG, 105 °C	<p>Female</p> <p>1. RD/WH 2. RD 3. GN 4. RD/YE 5. RD/BK 6. RD/BU</p> <p>Male</p>

We reserve the right to make technical alterations without prior notice.

* Length in meters. Standard lead length is 0.5 meters. Consult factory for other lengths.
Standard housing material is nickel plated brass..“FSB ..”.
To specify PVC jacketed cable, add “/S717” to the end of the part number.

2, 3 and 4-Wire Receptacles, Front Mount, 1/2-14 NPT Threads

- NEMA 1, 3, 4, 6P
- IEC IP67 Protection
- 250 V, 4 A



We reserve the right to make technical alterations without prior notice.

Housing Style	Female Part Number	Male Part Number	Features	Pinout
<p>FKB ...</p> <p>Typical panel cutout 22.5 mm</p>	FKB 2-*/14.5/NPT	FSB 2-*/14.5/NPT	2x18 AWG, 105 °C	<p>Female</p> <p>Male</p> <p>1. BN 2. BU</p>
<p>FSB ...</p> <p>Typical panel cutout 22.5 mm</p>	FKB 3-*/14.5/NPT	FSB 3-*/14.5/NPT	3x22 AWG, 105 °C	<p>Female</p> <p>Male</p> <p>1. GN 2. RD/BK 3. RD/WH</p>
<p>FSB ...</p> <p>Typical panel cutout 22.5 mm</p>	FKB 4-*/14.5/NPT	FSB 4-*/14.5/NPT	4x22 AWG, 105 °C	<p>Female</p> <p>Male</p> <p>1. RD/BK 2. RD/WH 3. RD 4. GN</p>

microfast®

* Length in meters. Standard lead length is 0.5 meters. Consult factory for other lengths.
Standard housing material is nickel plated brass. "FSB...".
To specify PVC jacketed cable, add "/S717" to the end of the part number.

- NEMA 1, 3, 4, 6P
- IEC IP67 Protection
- 250 V, 4 A



Housing Style	Female Part Number	Male Part Number	Features	Pinout
<p>FKB ...</p> <p>Typical panel cutout 22.5 mm</p>	FKB 5-*/14.5/NPT	FSB 5-*/14.5/NPT	5x22 AWG, 105 °C	<p>Female</p> <p>1. RD/WH 2. RD 3. GN 4. RD/YE 5. RD/BK</p> <p>Male</p>
		FSB 5-*/14.5/NPT/S690	5x18 AWG, 105 °C	<p>Male</p>
<p>FSB ...</p> <p>Typical panel cutout 22.5 mm</p>	FKB 6-*/14.5/NPT	FSB 6-*/14.5/NPT	6x22 AWG, 105 °C	<p>Female</p> <p>1. RD/WH 2. RD 3. GN 4. RD/YE 5. RD/BK 6. RD/BU</p> <p>Male</p>

We reserve the right to make technical alterations without prior notice.

* Length in meters. Standard lead length is 0.5 meters. Consult factory for other lengths. Standard housing material is nickel plated brass..“FSB..”. To specify PVC jacketed cable, add “/S717” to the end of the part number.

2 and 3-Wire Receptacles, Front Mount, 1/4-18 NPT Threads

- NEMA 1, 3, 4, 6P
- IEC IP67 Protection
- 250 V, 4 A



Housing Style	Female Part Number	Male Part Number	Features	Pinout
<p>FKB ...</p>	FKB 2-*/18.25	FSB 2-*/18.25	2x18 AWG, 105 °C	<p>Female</p> <p>Male</p>
	FKB 3-*/18.25	FSB 3-*/18.25	3x22 AWG, 105 °C	<p>Female</p>
	FKB 3-*/18.25/S690	FSB 3-*/18.25/S690	3x18 AWG 105 °C	<p>Female</p>
<p>FSB ...</p>		FSB 3-*/18.25/S649	3x22 AWG 105 °C	<p>Female</p>
	FKB 3-*/18.25/S662	FSB 3-*/18.25/S662	3x18 AWG 105 °C	<p>Male</p>
		FSB 3-*/18.25/S881	3x22 AWG 105 °C	<p>Male</p>

We reserve the right to make technical alterations without prior notice.

microfast®

* Length in meters. Standard lead length is 0.5 meters. Consult factory for other lengths.
 Standard housing material is nickel plated brass. "FSB ..". "FSBV.." indicates stainless steel housing.
 To specify PVC jacketed cable, add "/S717" to the end of the part number.

1/2" microfast® Connectivity

4, 5 and 6-Wire Receptacles, Front Mount, 1/4-18 NPT Threads



- NEMA 1, 3, 4, 6P
- IEC IP67 Protection
- 250 V, 4 A



Housing Style	Female Part Number	Male Part Number	Features	Pinout
<p>FKB ...</p> <p>Typical panel cutout is 14.3 mm</p>		FSB 4-*/18.25/S621	4x18 AWG, 105 °C	<p>Female</p>
	FKB 4-*/18.25	FSB 4-*/18.25	4x22 AWG, 105 °C	<p>Male</p>
		FSB 4-*/18.25/S727	4x22 AWG, 105 °C	<p>Female</p>
<p>FSB ...</p> <p>Typical panel cutout is 14.3 mm</p>	FKB 5-*/18.25	FSB 5-*/18.25	5x22 AWG, 105 °C	<p>Female</p>
	FKB 5-*/18.25/S690	FSB 5-*/18.25/S690	5x18 AWG, 105 °C	<p>Male</p>
<p>FSB ...</p> <p>Typical panel cutout is 14.3 mm</p>	FKB 6-*/18.25	FSB 6-*/18.25	6x22 AWG, 105 °C	<p>Female</p>
				<p>Male</p>

We reserve the right to make technical alterations without prior notice.

* Length in meters. Standard lead length is 0.5 meters. Consult factory for other lengths.
 Standard housing material is nickel plated brass. "FSB ..". "FSBV.." indicates stainless steel housing.
 To specify PVC jacketed cable, add "/S717" to the end of the part number.

3 and 5-Wire Female Receptacles, Back Panel Mount, 11/16-24 Threads

- NEMA 1, 3, 4, 6P
- IEC IP67 Protection
- 250 V, 4 A



Housing Style	Female Part Number	Features	Pinout
<p>FKBP ...</p> <p>Recommended panel thickness is 5.1 mm and typical panel cutout is 17.5 x 3.2 x 1.6 mm</p>	FKBP 3-*	3x18 AWG, 105 °C	<p>Female</p>
	FKBP 5-*	5x18 AWG, 105 °C	<p>Female</p>

Standard housing material is nickel plated brass.

microfast®

3, 4 and 5-Wire Shielded Bulkhead Feed-Thru Receptacles

- NEMA 1, 3, 4, 6P
- IEC IP67 Protection
- 250 V, 4 A



Housing Style	Part Number	Features	Pinout
<p>FKB FSB ..</p> <p>Recommended panel cutout thickness is 5.1 mm and typical panel cutout is 12.5 or 15.9 mm</p>	FKB FSB 3	3-pin, 105 °C	<p>Female</p>
	FKB FSB 4	4-pin, 105 °C	<p>Female</p>
	FKB FSB 5	5-pin, 105 °C	<p>Female</p>

Standard housing material is nickel plated brass.

We reserve the right to make technical alterations without prior notice.

- NEMA 1, 3, 4, 6P
- IEC IP67 Protection



Housing Style	Female Part Number	Male Part Number	Features	Pinout
<p>MF 3131-0</p>	MF 3131-0	MFS 3131-0	PBT, black, PG 7 cable diameter gland, accepts 4-6 mm cable diameter, screw terminals, accepts up to 18 AWG conductor, 85 °C, 250 V, 4 A, mates with 3-wire cordsets and receptacles	<p>Female</p>
<p>MF 3231-0</p>				
<p>MFS 3131-0</p>	MF 3231-0	MFS 3231-0	PBT, black, PG 7 cable diameter gland, accepts 4-6 mm cable diameter, screw terminals, accepts up to 18 AWG conductor, 85 °C, 250 V, 4 A, mates with 3-wire cordsets and receptacles	<p>Male</p>
<p>MFS 3231-0</p>				

We reserve the right to make technical alterations without prior notice.

Adapters

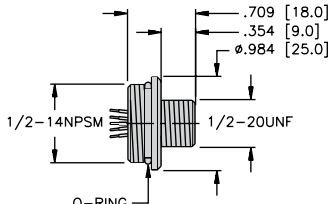
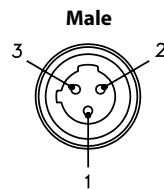
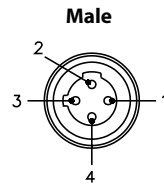
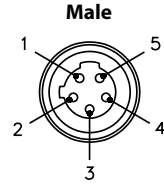
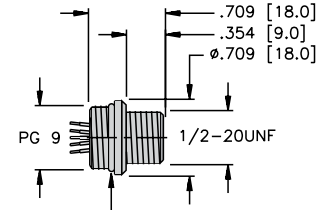
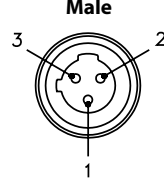
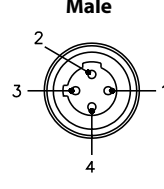
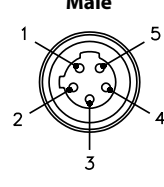
Housing Style	Part Number	Features	Pinout
 <p>Typical panel cutout is 22.5 mm</p>	B3131-*	Nickel plated brass, 3x26 AWG leads, 80 °C, 250 V, 4 A, Mates with 3-pin cordsets, 1/2-14 NPSM thread	<p>1. GN 2. BN 3. BU</p> 
	B3141-*	Nickel plated brass, 4x22 AWG leads, 80 °C, 250 V, 4 A, Mates with 4-pin cordsets, 1/2-14 NPSM thread	<p>1. RD/BK 2. RD/WH 3. RD 4. GN</p> 
	B3151-*	Nickel plated brass, 5x26 AWG leads, 80 °C, 250 V, 4 A, Mates with 5-pin cordsets, 1/2-14 NPSM thread	<p>1. RD/WH 2. RD 3. GN 4. RD/YE 5. RD/BK</p> 
 <p>Typical panel cutout is 22.5 mm</p>	B3131-PG9-*	Nickel plated brass, 3x26 AWG leads, 80 °C, 250 V, 4 A, Mates with 3-pin cordsets, PG 9 thread	<p>1. GN 2. BN 3. BU</p> 
	B3141-PG9-*	Nickel plated brass, 4x22 AWG leads, 80 °C, 250 V, 4 A, Mates with 4-pin cordsets, PG 9 thread	<p>1. RD/BK 2. RD/WH 3. RD 4. GN</p> 
	B3151-PG9-*	Nickel plated brass, 5x26 AWG leads, 80 °C, 250 V, 4 A, Mates with 5-pin cordsets, PG 9 thread	<p>1. RD/WH 2. RD 3. GN 4. RD/YE 5. RD/BK</p> 

We reserve the right to make technical alterations without prior notice.

microfast®

Accessories

- For use in Sensors and Custom Receptacles
- Compatible with Standard Microfast Cordsets



Housing Style	Part Number	Features	Pinout
	ESBW 3 (10/BAG)	Nylon solder cup, accepts up to 22 AWG, 80 °C, 250 V, 4 A, up to 3 conductors	<p>Male</p>
	ESBW 4 (10/BAG)	Nylon solder cup, accepts up to 22 AWG, 80 °C, 250 V, 4 A, up to 4 conductors	<p>Male</p>
	ESBW 5 (10/BAG)	Nylon solder cup, accepts up to 22 AWG, 80 °C, 250 V, 4 A, up to 5 conductors	<p>Male</p>
	SB-CC (10/BAG)	Polypropylene closer cap, mates to female cordsets, receptacles and junction boxes	

We reserve the right to make technical alterations without prior notice.

Part Number Keys	F2
Cordsets	F6
Receptacles	F24
Field Wireables	F48
Tees	F53
Closure Caps	F60
Accessories	F63

Features

- 7/8-16, 1-16 and 1 1/8-16 UN thread connectors
- 7/8" available in 2 to 6-pin
- 1" available in 6 to 8-pin
- 1 1/8" available in 9, 10, 12 and 19-pin
- Up to 10 Amp, 600 Volt rated
- Limited power and control applications



Cordset Part Number key

Part Number Keys are to assist in IDENTIFICATION ONLY. Consult factory for catalog items not identified.



7/8", 1" & 1 1/8" Minifast Cordset

- R = straight
- W = right angle

Gender

- K = female connector, female threads
- S = male connector, male threads
- Y = male connector, female threads
- X = female connector, male threads

Coupling Nut Material

- (blank) = nylon
- M = nickel plated brass
- V = stainless steel (hex on 1", 1 1/8" and knurl on 7/8")
- VH = stainless steel (hex on 7/8")

Insertion Point of Extension Cable and Second Prefix*

- * Male connector listed first, female connector second
- Example: **RSM RKM 40-2M**

Varieties

- (blank) = PVC jacket
- /S90 = TPU jacket
- /S90-SP = TPU coil cord
- /S101 = Flexlife-20, high flex cable
- /S529 = yellow TPU jacket, braided shield, PVC inner jacket
- /S600 = CPE, rubber jacket
- /S824 = yellow PLTC
- /S1077 = silicone tubing
- /S1587 = TPE, Weldlife
- /S.. = consult factory, special
- /CS.. = consult factory, special
- /S760 = black cable, black mold body
- /S771 = black cable, black mold body

Length in Meters

Number of Wires / AWG / Color Codes

20	=	2x18 AWG	BN, BU
26	=	2x16 AWG	WH, BK
28A	=	2x18 AWG	WH, BK
30	=	3x18 AWG	GN/YE, BN, BU
31	=	3x18 AWG	BK, BN, BU
35	=	3x16 AWG	GN, RD/BK, RD/WH
36	=	3x16 AWG	GN, BK, WH
38A	=	3x18 AWG	GN, BK, WH
311	=	3x18 AWG	GN, RD/BK, RD/WH
40	=	4x18 AWG	BN, WH, BU, BK
46	=	4x16 AWG	BK, WH, RD, GN
47	=	4x16 AWG	BN, WH, BU, GN/YE
48A	=	4x18 AWG	BK, WH, RD, GN
50	=	5x18 AWG	BK, BU, GN/YE, BN, WH
55	=	5x16 AWG	RD/WH, RD/BU, GN, RD/OG, RD/BK
56	=	5x16 AWG	WH, RD, GN, OG, BK
58A	=	5x18 AWG	WH, RD, GN, OG, BK
511	=	5x18 AWG	RD/WH, RD/BU, GN, RD/OG, RD/BK
61	=	6x18 AWG	GN, WH, BU, GY, YE, BN
66	=	6x16 AWG	WH, RD, GN, OG, BK, BU
68A	=	6x18 AWG	WH, RD, GN, OG, BK, BU
686	=	6x16 AWG	OG, BU, BK, WH, RD, GN
76	=	7x16 AWG	WH/BK, BK, WH, RD, OG, BU, GN
86	=	8x16 AWG	OG, BU, WH/BK, BK, WH, RD, GN, RD/BK
96	=	9x16 AWG	OG, BU, RD/BK, GN/BK, WH, RD, GN, WH/BK, BK
106	=	10x16 AWG	OG, BU, WH/BK, RD/BK, GN/BK, OG/BK, RD, GN, BK, WH
126	=	12x16 AWG	OG, BU, WH/BK, RD/BK, GN/BK, OG/BK, BU/BK, BK/WH, GN, RD, WH, BK

__A Metal Clad Cable (18 AWG straight only)

__D Smooth Plug Body (16 AWG straight only)

Cordset Part Number Key

Extension Examples:

Hybrid connector extensions also available. Consult factory.

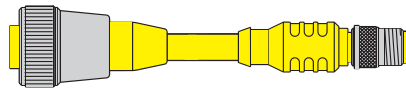

R K M 40 - 2M - R S C 4.4T

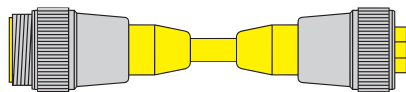

R S M R K M 30 - 4M /S..

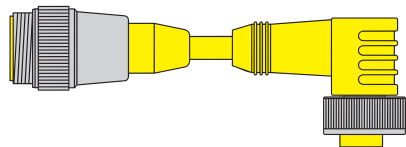

R S M W K M 30 - 4M /S..

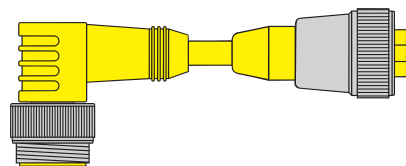

W S M R K M 30 - 4M /S..

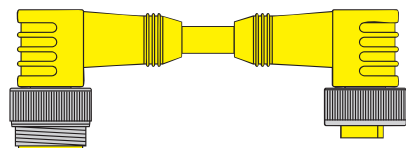

W S M W K M 30 - 4M /S..

minifast®

Receptacle Part Number key

Part Number Keys are to assist in IDENTIFICATION ONLY. Consult factory for catalog items not identified.

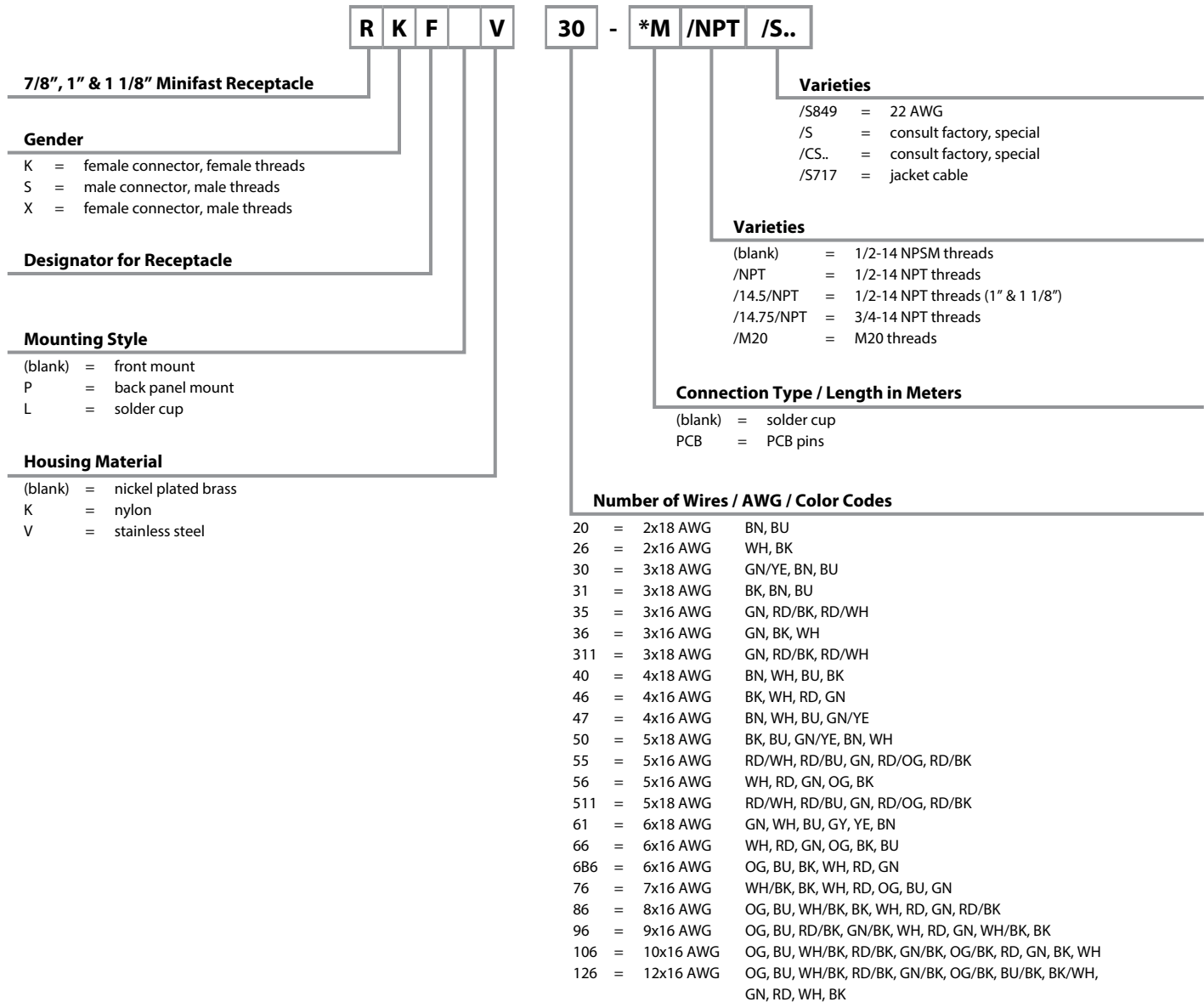

7/8", 1" & 1 1/8" Minifast Receptacle

Gender

- K = female connector, female threads
- S = male connector, male threads
- X = female connector, male threads

Designator for Receptacle

Mounting Style

- (blank) = front mount
- P = back panel mount
- L = solder cup

Housing Material

- (blank) = nickel plated brass
- K = nylon
- V = stainless steel

Varieties

- /S849 = 22 AWG
- /S = consult factory, special
- /CS.. = consult factory, special
- /S717 = jacket cable

Varieties

- (blank) = 1/2-14 NPSM threads
- /NPT = 1/2-14 NPT threads
- /14.5/NPT = 1/2-14 NPT threads (1" & 1 1/8")
- /14.75/NPT = 3/4-14 NPT threads
- /M20 = M20 threads

Connection Type / Length in Meters

- (blank) = solder cup
- PCB = PCB pins

Number of Wires / AWG / Color Codes

- 20 = 2x18 AWG BN, BU
- 26 = 2x16 AWG WH, BK
- 30 = 3x18 AWG GN/YE, BN, BU
- 31 = 3x18 AWG BK, BN, BU
- 35 = 3x16 AWG GN, RD/BK, RD/WH
- 36 = 3x16 AWG GN, BK, WH
- 311 = 3x18 AWG GN, RD/BK, RD/WH
- 40 = 4x18 AWG BN, WH, BU, BK
- 46 = 4x16 AWG BK, WH, RD, GN
- 47 = 4x16 AWG BN, WH, BU, GN/YE
- 50 = 5x18 AWG BK, BU, GN/YE, BN, WH
- 55 = 5x16 AWG RD/WH, RD/BU, GN, RD/OG, RD/BK
- 56 = 5x16 AWG WH, RD, GN, OG, BK
- 511 = 5x18 AWG RD/WH, RD/BU, GN, RD/OG, RD/BK
- 61 = 6x18 AWG GN, WH, BU, GY, YE, BN
- 66 = 6x16 AWG WH, RD, GN, OG, BK, BU
- 6B6 = 6x16 AWG OG, BU, BK, WH, RD, GN
- 76 = 7x16 AWG WH/BK, BK, WH, RD, OG, BU, GN
- 86 = 8x16 AWG OG, BU, WH/BK, BK, WH, RD, GN, RD/BK
- 96 = 9x16 AWG OG, BU, RD/BK, GN/BK, WH, RD, GN, WH/BK, BK
- 106 = 10x16 AWG OG, BU, WH/BK, RD/BK, GN/BK, OG/BK, RD, GN, BK, WH
- 126 = 12x16 AWG OG, BU, WH/BK, RD/BK, GN/BK, OG/BK, BU/BK, BK/WH, GN, RD, WH, BK

Field Wireable Part Number Key

Part Number Keys are to assist in IDENTIFICATION ONLY. Consult factory for catalog items not identified.

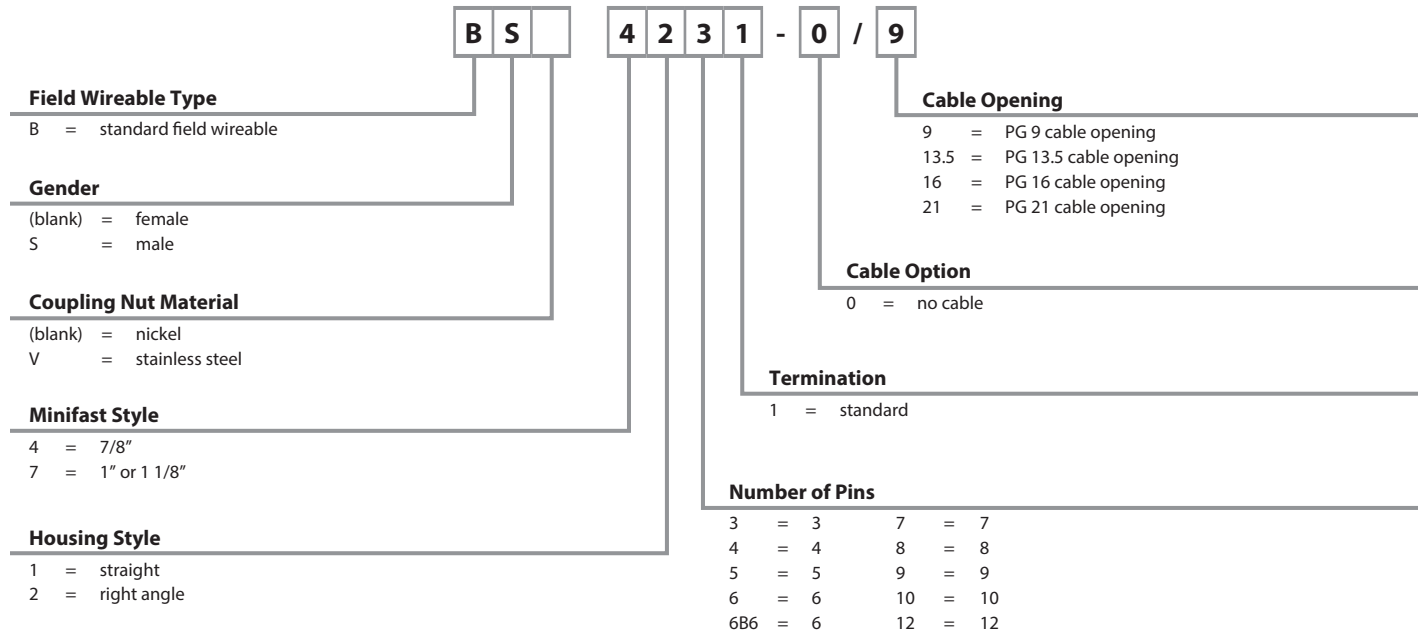

minifast®

- NEMA 1, 3, 4, 6P
- IEC IP67 Protection
- 9 A



Connector Style	Female Part Number	Male Part Number	Features	Pinout
<p>RKM ..**</p> <p>WKM ..**</p>	<p>RKM 20- *M WKM 20- *M</p>	<p>RSM 20- *M WSM 20- *M</p>	<p>ITC/PLTC PVC Yellow 2x18 AWG, 105 °C, 6.2 mm OD, Cable #RF50511- *M, Flexlife®, 600 V</p>	<p>1. BN 2. BU</p>
<p>RKM 30- *M WKM 30- *M</p>	<p>RKM 30- *M WKM 30- *M</p>	<p>RSM 30- *M WSM 30- *M</p>	<p>ITC/PLTC PVC Yellow, 3x18 AWG, 105 °C, 6.2 mm OD, Cable #RF50880- *M, Flexlife, 600 V</p>	<p>1. GN/YE 2. BN 3. BU</p>
<p>RSM ..**</p>	<p>RKM 30- *M/S90 WKM 30- *M/S90</p>	<p>RSM 30- *M/S90 WSM 30- *M/S90</p>	<p>AWM TPU Yellow, 3x18 AWG , 90 °C, 6.0 mm OD, Cable #RF50545- *M, Cut Abrasion Immune, 600 V</p>	
<p>RSM ..**</p>	<p>RKM 30- *M/S101 WKM 30- *M/S101</p>	<p>RSM 30- *M/S101 WSM 30- *M/S101</p>	<p>AWM TPE Yellow, 3x18 AWG , 105 °C, 5.7 mm OD, Cable #RF51173- *M, Flexlife-20, high flex over 20 million cycles, 600 V C-track</p>	
<p>WSM ..**</p>	<p>RKM 311- *M WKM 311- *M</p>	<p>RSM 311- *M WSM 311- *M</p>	<p>ITC/PLTC PVC Yellow, 3x18 AWG, 105 °C, 6.2 mm OD, Cable #RF50520- *M, Flexlife, 600 V</p>	<p>1. GN 2. RD/BK 3. RD/WH</p>
<p>WSM ..**</p>	<p>RKM 311- *M/S600 WKM 311- *M/S600</p>	<p>RSM 311- *M/S600 WSM 311- *M/S600</p>	<p>SJOOW CPE, Yellow, 3x18 AWG , 105 °C, 8.0 mm OD, Cable #RF50658- *M, Weld Flash Immune, Flame Immune, 300 V</p>	

We reserve the right to make technical alterations without prior notice.

* Length in meters. Standard cable lengths are 2, 4, 5, 6, 8 and 10 meters. Consult factory for other lengths.

** Standard coupling nut material is nickel plated brass "RKM .."; "RK .." indicates nylon, "RKV .." indicates stainless steel, and "RKVH .." indicates stainless steel hex.

3-Wire Cordsets, Standard

- NEMA 1, 3, 4, 6P
- IEC IP67 Protection
- 9 A



Connector Style	Female Part Number	Male Part Number	Features	Pinout	
<p>RKM ..**</p>	RKM 31-*M WKM 31-*M	RSM 31-*M WSM 31-*M	ITC/PLTC PVC Yellow, 3x18 AWG, 105 °C, 6.2 mm OD, Cable #RF50513-*M, Flexlife®, 600 V	Female 	
<p>WKM ..**</p>					1. BK 2. BN 3. BU
<p>RSM ..**</p>	RKM 31-*M/S600 WKM 31-*M/S600	RSM 31-*M/S600 WSM 31-*M/S600		SJOOW CPE Yellow, 3x18 AWG, 105 °C, 8.0 mm OD, Cable #RF50654-*M, Weld Flash Immune, Flame Immune, 300 V	Male
<p>WSM ..**</p>					

We reserve the right to make technical alterations without prior notice.

* Length in meters. Standard cable lengths are 2, 4, 5, 6, 8 and 10 meters. Consult factory for other lengths.

** Standard coupling nut material is nickel plated brass "RKM .."; "RK .." indicates nylon, "RKV .." indicates stainless steel, and "RKVH .." indicates stainless steel hex.

Cordsets

3 and 4-Wire Cordsets, Standard

- NEMA 1, 3, 4, 6P
- IEC IP67 Protection
- 9 A



Connector Style	Female Part Number	Male Part Number	Features	Pinout
<p>RKM ..**</p>	RKM 40-*M WKM 40-*M	RSM 40-*M WSM 40-*M	ITC/PLTC PVC Yellow, 4x18 AWG, 105 °C, 6.7 mm OD, Cable #RF50548-*M, Flexlife®, 600 V	<p>Female</p> <p>Male</p>
<p>WKM ..**</p>	RKM 40-*M/S90 WKM 40-*M/S90	RSM 40-*M/S90 WSM 40-*M/S90	AWM TPU Yellow, 4x18 AWG, 90 °C, 7.2 mm OD, Cable #RF50544-*M, Cut/Abrasion Immune, 600 V	
<p>RSM ..**</p>	RKM 40-*M/S101 WKM 40-*M/S101	RSM 40-*M/S101 WSM 40-*M/S101	AWM TPE Yellow, 4x18 AWG, 105 °C, 6.2 mm OD, Cable #RF50968-*M, Flexlife-20, High Flex - Over 20 million cycles, 600 V, C-track	
<p>RSM ..**</p>	RKM 40-*M/S529 WKM 40-*M/S529	RSM 40-*M/S529 WSM 40-*M/S529	TPU Yellow, 4x20 AWG, 90 °C, 5.7 mm OD, Cable #RF50526-*M, Cut/Abrasion Immune, Braided Mechanical Shield, 300 V	
<p>WSM ..**</p>	RKM 40-*M/S600 WKM 40-*M/S600	RSM 40-*M/S600 WSM 40-*M/S600	SJOOW CPE Yellow, 4x18 AWG, 105 °C, 8.5 mm OD, Cable #RF50644-*M, Weld Flash Immune, Flame Immune, 300 V	

We reserve the right to make technical alterations without prior notice.

* Length in meters. Standard cable lengths are 2, 4, 5, 6, 8 and 10 meters. Consult factory for other lengths.

** Standard coupling nut material is nickel plated brass "RKM .."; "RK .." indicates nylon, "RKM .." indicates stainless steel, and "RKVH .." indicates stainless steel hex.

5-Wire Cordsets, Standard

- NEMA 1, 3, 4, 6P
- IEC IP67 Protection
- 9 A



We reserve the right to make technical alterations without prior notice.

Connector Style	Female Part Number	Male Part Number	Features	Pinout
<p>RKM ..**</p>	RKM 50-*M WKM 50-*M	RSM 50-*M WSM 50-*M	ITC/PLTC PVC Yellow, 5x18 AWG, 105 °C, 7.6 mm OD, Cable #RF50549-*M, Flexlife®, 600 V	
	RKM 50-*M/S90 WKM 50-*M/S90	RSM 50-*M/S90 WSM 50-*M/S90	AWM TPU Yellow, 5x18 AWG, 90 °C, 7.2 mm OD, Cable #RF50751-*M, Cut/Abrasion Immune, 600 V	1. BK 2. BU 3. GN/YE 4. BN 5. WH
<p>WKM ..**</p>	RKM 50-*M/S101 WKM 50-*M/S101	RSM 50-*M/S101 WSM 50-*M/S101	AWM TPE Yellow, 5x18 AWG, 105 °C, 6.7 mm OD, Cable #RF51174-*M, Flexlife-20, high flex over 20 million cycles, 600 V, C-track	
<p>RSM ..**</p>	RKM 50-*M/S1551 WKM 50-*M/S1551	RSM 50-*M/S1551 WSM 50-*M/S1551	ITC/PLTC PVC Yellow, 5x18 AWG, 105 °C, 7.6 mm OD, Cable #RF50578-*M, Yellow conductor instead of Green/Yellow, 600 V	1. BK 2. BU 3. YE 4. BN 5. WH
	RKM 511-*M WKM 511-*M	RSM 511-*M WSM 511-*M	ITC/PLTC PVC Yellow, 5x18 AWG, 105 °C, 7.6 mm OD, Cable #RF50521-*M, Flexlife, 600 V	
<p>WSM ..**</p>	RKM 511-*M/S600 WKM 511-*M/S600	RSM 511-*M/S600 WSM 511-*M/S600	SJOOW CPE Yellow, 5x18 AWG, 105 °C, 9.4 mm OD, Cable #RF50659-*M, Weld Flash Immune, Flame Immune, 300 V	

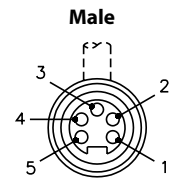
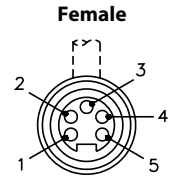

Cordsets

* Length in meters. Standard cable lengths are 2, 4, 5, 6, 8 and 10 meters. Consult factory for other lengths.

** Standard coupling nut material is nickel plated brass "RKM .."; "RK .." indicates nylon, "RKV .." indicates stainless steel, and "RKVH .." indicates stainless steel hex.

6-Wire Cordsets, Standard

- NEMA 1, 3, 4, 6P
- IEC IP67 Protection
- 8 A



Connector Style	Female Part Number	Male Part Number	Features	Pinout
<p>RKM ..**</p>	RKM 61-*M WKM 61-*M	RSM 61-*M WSM 61-*M	ITC/PLTC PVC Yellow, 6x18 AWG, 105 °C, 8.4 mm OD, Cable #RF50575-*M, Flexlife®, 600 V	<ol style="list-style-type: none"> 1. BN 2. N/C 3. GN/YE 4. N/C 5. BU 6. N/C <p style="text-align: center;">Female</p>
<p>WKM ..**</p>	RKM 61-*M/S739 WKM 61-*M/S739	RSM 61-*M/S739 WSM 61-*M/S739	ITC/PLTC PVC Yellow, 7x18 AWG, 105 °C, 8.4 mm OD, Cable #RF50637-*M, Shielded cable with drain wire, not connected at plug, 600 V	<ol style="list-style-type: none"> 1. GN 2. WH 3. BU 4. Gy 5. YE 6. BN
<p>RSM ..**</p>				
<p>WSM ..**</p>	RKM 61-*M/S763 WKM 61-*M/S763	RSM 61-*M/S763 WSM 61-*M/S763	ITC/PLTC PVC Black, 6x18 AWG, 105 °C, 8.4 mm OD, Cable #RF50551-*M, Shielded cable with drain wire, not connected at plug, 600 V	<ol style="list-style-type: none"> 1. BU 2. WH 3. BK 4. GN 5. RD 6. OG <p style="text-align: center;">Male</p>

We reserve the right to make technical alterations without prior notice.

* Length in meters. Standard cable lengths are 2, 4, 5, 6, 8 and 10 meters. Consult factory for other lengths.

** Standard coupling nut material is nickel plated brass "RKM .."; "RK .." indicates nylon, "RKM .." indicates stainless steel, and "RKVH .." indicates stainless steel hex.

2 and 3-Wire Cordsets, Heavy Duty

- NEMA 1, 3, 4, 6P
- IEC IP67 Protection
- 600 V, 10 A



We reserve the right to make technical alterations without prior notice.

Connector Style	Female Part Number	Male Part Number	Features	Pinout
<p>RKM ..** 2.559 [65.0] ϕ1.063 [27.0] 7/8-16UN</p>	RKM 26-*M WKM 26-*M	RSM 26-*M WSM 26-*M	STOOW PVC Yellow 2x16 AWG, 105 °C, 9.6 mm OD, Cable #RF50561-*M, Flexlife®	<p>Female</p> <p>Male</p>
<p>WKM ..** 2.126 [54.0] 1.583 [40.2] ϕ1.024 [26.0] 7/8-16UN</p>	RKM 35-*M WKM 35-*M	RSM 35-*M WSM 35-*M	STOOW PVC Yellow, 3x16 AWG, 105 °C, 10.0 mm OD, Cable #RF50537-*M, Flexlife	<p>Female</p>
<p>RSM ..** 2.697 [68.5] ϕ1.063 [27.0] 7/8-16UN</p>	RKM 35-*M/S600 WKM 35-*M/S600	RSM 35-*M/S600 WSM 35-*M/S600	SOOW CPE Yellow, 3x16 AWG, 105 °C, 10.3 mm OD, Cable #RF50596-*M, Weld Flash Immune, Flame Immune	<p>Female</p>
<p>WKM ..** 2.126 [54.0] 1.720 [43.7] ϕ1.024 [26.0] 7/8-16UN</p>	RKM 36-*M WKM 36-*M	RSM 36-*M WSM 36-*M	STOOW PVC Yellow, 3x16 AWG, 105 °C, 10.0 mm OD, Cable #RF50536-*M, Flexlife	<p>Male</p>
<p>WSM ..** 2.126 [54.0] 1.720 [43.7] ϕ1.024 [26.0] 7/8-16UN</p>	RKM 36-*M/S1587 WKM 36-*M/S1587	RSM 36-*M/S1587 WSM 36-*M/S1587	SEOOW/STOOW TPE Yellow, 3x16 AWG, 105 °C, 10.0 mm OD, Cable #RF51563-*M, Weldlife, Weld Flash Immune	<p>Male</p>

* Length in meters. Standard cable lengths are 2, 4, 5, 6, 8 and 10 meters. Consult factory for other lengths.

** Standard coupling nut material is nickel plated brass "RKM .."; "RK .." indicates nylon, "RKV .." indicates stainless steel, and "RKVH .." indicates stainless steel hex.

Cordsets

4-Wire Cordsets, Heavy Duty

- NEMA 1, 3, 4, 6P
- IEC IP67 Protection
- 600 V, 10 A



Connector Style	Female Part Number	Male Part Number	Features	Pinout
<p>RKM ..**</p>	RKM 46-*M WKM 46-*M	RSM 46-*M WSM 46-*M	STOOW PVC Yellow, 4x16 AWG, 105 °C, 10.8 mm OD, Cable #RF50538-*M, Flexlife®	<p>Female</p>
<p>WKM ..**</p>	RKM 46-*M/S600 WKM 46-*M/S600	RSM 46-*M/S600 WSM 46-*M/S600	SOOW CPE Yellow, 4x16 AWG, 105 °C, 11 mm OD, Cable #RF50595-*M, Weld Flash Immune, Flame Immune	<p>1. BK 2. WH 3. RD 4. GN</p>
<p>RSM ..**</p>	RKM 46-*M/S824 WKM 46-*M/S824	RSM 46-*M/S824 WSM 46-*M/S824	TC PVC Yellow, 4x16 AWG, 90 °C, 9.2 mm OD, Cable #RF51220-*M, Tray Rated	<p>Male</p>
<p>WSM ..**</p>	RKM 47-*M WKM 47-*M	RSM 47-*M WSM 47-*M	STOOW PVC Yellow, 4x16 AWG, 105 °C, 10.8 mm OD, Cable #RF50626-*M, Flexlife	<p>1. BN 2. WH 3. BU 4. GN/YE</p> <p>Female</p> <p>Male</p>

We reserve the right to make technical alterations without prior notice.

* Length in meters. Standard cable lengths are 2, 4, 5, 6, 8 and 10 meters. Consult factory for other lengths.

** Standard coupling nut material is nickel plated brass "RKM .."; "RK .." indicates nylon, "RKV .." indicates stainless steel, and "RKVH .." indicates stainless steel hex.

5 and 6-Wire Cordsets, Heavy Duty

- NEMA 1, 3, 4, 6P
- IEC IP67 Protection
- 600 V, 10 A (5-pin), 8 A (6-pin)



We reserve the right to make technical alterations without prior notice.

Connector Style	Female Part Number	Male Part Number	Features	Pinout
<p>RKM ..**</p>	<p>RKM 55-*M WKM 55-*M</p>	<p>RSM 55-*M WSM 55-*M</p>	<p>STOOW PVC Yellow, 5x16 AWG, 105 °C, 12.7 mm OD, Cable #RF50540-*M, Flexlife®</p>	<p>1. RD/WH 2. RD/BU 3. GN 4. RD/OG 5. RD/BK</p> <p>Female</p>
	<p>RKM 55-*M/S600 WKM 55-*M/S600</p>	<p>RSM 55-*M/S600 WSM 55-*M/S600</p>	<p>SOOW CPE Yellow, 5x16 AWG, 105 °C, 13 mm OD, Cable #RF50597-*M, Weld Flash Immune, Flame Immune</p>	<p>1. RD 2. RD 3. GN 4. RD 5. RD</p>
<p>WKM ..**</p>	<p>RKM 56-*M WKM 56-*M</p>	<p>RSM 56-*M WSM 56-*M</p>	<p>STOOW PVC Yellow, 5x16 AWG, 105 °C, 12.7 mm OD, Cable #RF50539-*M, Flexlife</p>	<p>1. WH 2. RD 3. GN 4. OG 5. BK</p> <p>Male</p>
	<p>RKM 56-*M/S1587 WKM 56-*M/S1587</p>	<p>RSM 56-*M/S1587 WSM 56-*M/S1587</p>	<p>SEOOW/STOOW TPE Yellow, 5x16 AWG, 105 °C, 12.7 mm OD Cable #RF51265-*M, Weldlife, Weld Flash Immune</p>	
<p>RSM ..**</p>	<p>RKM 66-*M WKM 66-*M</p>	<p>RSM 66-*M WSM 66-*M</p>	<p>STOOW PVC Yellow, 6x16 AWG, 105 °C, 13.6 mm OD Cable #RF50565-*M,</p>	<p>1. WH 2. RD 3. GN 4. OG 5. BK 6. BU</p> <p>Female</p>
	<p>RKM 66-*M/S1587 WKM 66-*M/S1587</p>	<p>RSM 66-*M/S1587 WSM 66-*M/S1587</p>	<p>SEOOW TPE Yellow, 6x16 AWG, 105 °C, 13.6 mm OD, Cable #RF51564-*M, Weldlife, Weld Flash Immune</p>	<p>Male</p>

* Length in meters. Standard cable lengths are 2, 4, 5, 6, 8 and 10 meters. Consult factory for other lengths.

** Standard coupling nut material is nickel plated brass "RKM .."; "RK .." indicates nylon, "RKV .." indicates stainless steel, and "RKHV .." indicates stainless steel hex.

Cordsets

- NEMA 1, 3, 4, 6P
- IEC IP68 Protection
- 600 V, 8 A



Connector Style	Female Part Number	Male Part Number	Features	Pinout
<p>RKM ..**</p>	RKM 6B6-*M WKM 6B6-*M	RSM 6B6-*M WSM 6B6-*M	ITC/PLTC PVC Yellow, 6x16 AWG, 105 °C, 9.0 mm OD, Cable #RF51030-*M, Flexlife®	<p>Female</p> <p>Male</p>
	RKM 6B6-*M/S90 WKM 6B6-*M/S90	RSM 6B6-*M/S90 WSM 6B6-*M/S90	AWM TPU Yellow, 6x16 AWG, 90 °C, 9.0 mm OD, Cable #RF51137-*M, Cut/abrasion Immune	
<p>WKM ..**</p>	RKM 6B6-*M/S101 WKM 6B6-*M/S101	RSM 6B6-*M/S101 WSM 6B6-*M/S101	AWM TPE Yellow, 6x16 AWG, 105 °C, 8.5 mm OD, Cable #RF51044-*M, Flexlife-20, High flex - over 20 million cycles, C-track	<p>1. OG 2. BU 3. BK 4. WH 5. RD 6. GN</p>
	RKM 76-*M WKM 76-*M	RSM 76-*M WSM 76-*M	ITC/PLTC PVC Yellow, 7x16 AWG, 105 °C, 9.6 mm OD, Cable #RF51031-*M, Flexlife	
<p>RSM ..**</p>	RKM 76-*M/S90 WKM 76-*M/S90	RSM 76-*M/S90 WSM 76-*M/S90	AWM TPU Yellow, 7x16 AWG, 90 °C, 9.0 mm OD, Cable #RF51138-*M, Cut/abrasion Immune	<p>1. WH/BK 2. BK 3. WH 4. RD 5. OG 6. BU 7. GN</p>
	RKM 76-*M/S101 WKM 76-*M/S101	RSM 76-*M/S101 WSM 76-*M/S101	AWM TPE Yellow, 7x16 AWG, 105 °C, 9.6 mm OD, Cable #RF51049-*M, Flexlife-20, High flex - over 20 million cycles, C-track	
<p>WSM ..**</p>	RKM 76-*M/S1587 WKM 76-*M/S1587	RSM 76-*M/S1587 WSM 76-*M/S1587	ITC/PLTC TPE Yellow, 7x16 AWG, 105 °C, 9.6 mm OD, Cable #RF51009-*M, Weldlife, Weld Flash Immune	<p>Female</p> <p>Male</p>

We reserve the right to make technical alterations without prior notice.

* Length in meters. Standard cable lengths are 2, 4, 5, 6, 8 and 10 meters. Consult factory for other lengths.

** Standard coupling nut material is nickel plated brass "RKM .."; "RKMV .." indicates stainless steel.

8-Wire Cordsets, B-Size Heavy Duty

- NEMA 1, 3, 4, 6P
- IEC IP68 Protection
- 600 V, 8 A



Connector Style	Female Part Number	Male Part Number	Features	Pinout
<p>RKM ..**</p>	RKM 86-*M WKM 86-*M	RSM 86-*M WSM 86-*M	ITC PLTC PVC Yellow, 8x16 AWG, 105 °C, 10.0 mm OD, Cable #RF51032-*M, Flexlife®	<p>Female</p> <p>Male</p>
<p>WKM ..**</p>	RKM 86-*M/S90 WKM 86-*M/S90	RSM 86-*M/S90 WSM 86-*M/S90	AWM TPU Yellow, 8x16 AWG, 90 °C, 10.0 mm OD, Cable #RF51139-*M, Cut/abrasion Immune	
<p>RSM ..**</p>	RKM 86-*M/S101 WKM 86-*M/S101	RSM 86-*M/S101 WSM 86-*M/S101	AWM TPE Yellow, 8x16, 105 °C, 10.5 mm OD, Cable #RF51050-*M, Flexlife-20, High flex - over 20 million cycles C-track	
<p>WSM ..**</p>	RKM 86-*M/S1587 WKM 86-*M/S1587	RSM 86-*M/S1587 WSM 86-*M/S1587	ITC/PLTC TPE Yellow, 8x16 AWG, 105 °C, 10.0 mm OD, Cable #RF51011-*M, Weldlife, Weld Flash Immune	

We reserve the right to make technical alterations without prior notice.

Cordsets

* Length in meters. Standard cable lengths are 2, 4, 5, 6, 8 and 10 meters. Consult factory for other lengths.

** Standard coupling nut material is nickel plated brass "RKM .."; "RKV .." indicates stainless steel.

1 1/8" minifast® Connectivity Products

9 and 10-Wire Cordsets, C-Size Heavy Duty



- NEMA 1, 3, 4, 6P
- IEC IP68 Protection
- 600 V, 7 A



Connector Style	Female Part Number	Male Part Number	Features	Pinout
<p>RKM ..**</p>	RKM 96-*M WKM 96-*M	RSM 96-*M WSM 96-*M	ITC/PLTC PVC Yellow, 9x16 AWG, 105 °C, 11.3 mm OD, Cable #RF51033-*M, Flexlife®	<p>Female</p>
	RKM 96-*M/S90 WKM 96-*M/S90	RSM 96-*M/S90 WSM 96-*M/S90	AWM TPU Yellow, 9x16 AWG, 90 °C, 10.5 mm OD, Cable #RF51140-*M, Cut/abrasion Immune	
<p>WKM ..**</p>	RKM 96-*M/S101 WKM 96-*M/S101	RSM 96-*M/S101 WSM 96-*M/S101	AWM TPE Yellow, 12x16 AWG, 105 °C, 13.7 mm OD, Cable #RF51148-*M, Flexlife-20, High flex - over 20 million cycles, C-track	<p>Male</p>
	RKM 96-*M/S1587 WKM 96-*M/S1587	RSM 96-*M/S1587 WSM 96-*M/S1587	ITC/PLTC TPE Yellow, 9x16 AWG, 105 °C, 11.2 mm OD, Cable #RF51013-*M, Weldlife, Weld Flash Immune	
<p>RSM ..**</p>	RKM 106-*M WKM 106-*M	RSM 106-*M WSM 106-*M	ITC/PLTC PVC Yellow, 10x16 AWG, 105 °C, 12.0 mm OD, Cable #RF51034-*M, Flexlife	<p>Female</p>
	RKM 106-*M/S90 WKM 106-*M/S90	RSM 106-*M/S90 WSM 106-*M/S90	AWM TPU Yellow, 10x16 AWG, 90 °C, 12.0 mm OD, Cable #RF51141-*M, Cut/abrasion Immune	
<p>WSM ..**</p>	RKM 106-*M/S101 WKM 106-*M/S101	RSM 106-*M/S101 WSM 106-*M/S101	AWM TPE Yellow, 12x16 AWG, 105 °C, 13.7 mm OD, Cable #RF51148-*M, Flexlife-20, High flex - over 20 million cycles, C-track	<p>Male</p>
	RKM 106-*M/S1587 WKM 106-*M/S1587	RSM 106-*M/S1587 WSM 106-*M/S1587	ITC/PLTC TPE Yellow, 10x16 AWG, 105 °C, 12.0 mm OD, Cable #RF51015-*M Weldlife, Weld Flash Immune	

We reserve the right to make technical alterations without prior notice.

* Length in meters. Standard cable lengths are 2, 4, 5, 6, 8 and 10 meters. Consult factory for other lengths.

** Standard coupling nut material is nickel plated brass "RKM .."; "RKV .." indicates stainless steel.

8-Wire Cordsets, B-Size Heavy Duty

- NEMA 1, 3, 4, 6P
- IEC IP68 Protection
- 250 V, 4 A



We reserve the right to make technical alterations without prior notice.

Connector Style	Female Part Number	Male Part Number	Features	Pinout
<p>RKM ..**</p>	RKM 126-*M WKM 126-*M	RSM 126-*M WSM 126-*M	ITC/PLTC PVC Yellow, 12x16 AWG, 105 °C, 12.5 mm OD, Cable #RF51035-*M, Flexlife®	<p>Female</p> <p>Male</p>
<p>WKM ..**</p>	RKM 126-*M/S90 WKM 126-*M/S90	RSM 126-*M/S90 WSM 126-*M/S90	AWM TPU Yellow, 12x16 AWG, 90 °C, 12.4 mm OD, Cable #RF51142-*M, Cut/abrasion Immune	
<p>RSM ..**</p>	RKM 126-*M/S101 WKM 126-*M/S101	RSM 126-*M/S101 WSM 126-*M/S101	AWM TPE Yellow, 12x16 AWG, 105 °C, 13.7 mm OD, Cable #RF51148-*M, Flexlife-20, High flex - over 20 million cycles, C-track	
<p>WSM ..**</p>	RKM 126-*M/S1587 WKM 126-*M/S1587	RSM 126-*M/S1587 WSM 126-*M/S1587	ITC/PLTC TPE Yellow, 12x16 AWG, 105 °C, 12.5 mm OD, Cable #RF51017-*M, Weldlife, Weld Flash Immune	

Cordsets

* Length in meters. Standard cable lengths are 2, 4, 5, 6, 8 and 10 meters. Consult factory for other lengths.
 ** Standard coupling nut material is nickel plated brass "RKM .."; "RKM .." indicates stainless steel.

1 1/8" minifast® Connectivity Products

19-Wire Cordsets, C-Size Heavy Duty



- NEMA 1, 3, 4, 6P
- IEC IP68 Protection



Connector Style	Female Part Number	Male Part Number	Features	Pinout
<p>RKM ..**</p>	RKM 190-*M WKM 190-*M	RSM 190-*M WSM 190-*M	ITC/PLTC PVC Yellow, 3x18, 16x22 AWG, 105 °C, 300 VAC/VDC, 4 A (pins 5, 7, & 12), 2 A (all other pins), 10.0 mm OD, Cable #RF50620-*M, Flexlife®	<p>Female</p> <p>Male</p>
<p>WKM ..**</p>	RKM 190-*M/S90 WKM 190-*M/S90	RSM 190-*M/S90 WSM 190-*M/S90	AWM TPU Yellow, 3x18, 16x22 AWG, 90 °C, 300 VAC/VDC, 4 A (pins 5, 7, & 12), 2 A (all other pins), 10.0 mm OD, Cable #RF50682-*M, Cut/abrasion Immune	
<p>RSM ..**</p>	RKM 190-*M/S101 WKM 190-*M/S101	RSM 190-*M/S101 WSM 190-*M/S101	AWM TPE Yellow, 3x18, 16x22 AWG, 105 °C, 300 VAC/VDC, 4 A (pins 5, 7, & 12), 2 A (all other pins), 11.2 mm OD, Cable #RF50916-*M, Flexlife-20, High flex - over 20 million cycles, C-track	
<p>WSM ..**</p>	RKM 190-*M/S760 WKM 190-*M/S760	RSM 190-*M/S760 WSM 190-*M/S760	ITC/PLTC PVC Black, 3x18, 16x22 AWG, 105 °C, 300 VAC/VDC, 4 A (pins 5, 7, & 12), 2 A (all other pins), 10.0 mm OD, Cable #RF50733-*M, Flexlife	

We reserve the right to make technical alterations without prior notice.

* Length in meters. Standard cable lengths are 2, 4, 5, 6, 8 and 10 meters. Consult factory for other lengths.

** Standard coupling nut material is nickel plated brass "RKM .."; "RKV .." indicates stainless steel.

2-6 Wire Extreme Duty, Armored Cordsets

- NEMA 1, 3, 4, 6P
- IEC IP67 Protection
- 300 V, 9 A (2-5-pin), 8 A (6-pin)



Connector Style	Female Part Number	Male Part Number	Features	Pinout
<p>RKM ..A**</p>	RKM 28A-*M	RSM 28A-*M	MC ITC/PLTC PVC Armor Yellow, 2x18 AWG, 105 °C, 14.4 mm OD, Cable #RF51039-*M, Armor Cable for Extreme Conditions, CSA Approved ITCERDB	<p>1. WH 2. BK</p>
	RKM 38A-*M	RSM 38A-*M	MC ITC/PLTC PVC Armor Yellow, 3x18 AWG, 105 °C, 14.9 mm OD, Cable #RF51040-*M, Armor Cable for Extreme Conditions, CSA Approved ITCERDB	<p>1. GN 2. BK 3. WH</p>
	RKM 48A-*M	RSM 48A-*M	MC ITC/PLTC PVC Armor Yellow, 4x18 AWG, 105 °C, 15.2 mm OD, Cable #RF51041-*M, Armor Cable for Extreme Conditions, CSA Approved ITCERDB	<p>1. BK 2. WH 3. RD 4. GN</p>
	RKM 58A-*M	RSM 58A-*M	MC PVC Armor Yellow, 5x18 AWG, 90 °C, 14.9 mm OD, Cable #RF51042-*M, Armor Cable for Extreme Conditions ITCERDB	<p>1. WH 2. RD 3. GN 4. OG 5. BK</p>
	RKM 68A-*M	RSM 68A-*M	MC PVC Armor Yellow, 6x18 AWG, 90 °C, 14.9 mm OD, Cable #RF51043-*M, Armor Cable for Extreme Conditions ITCERDB	<p>1. WH 2. RD 3. GN 4. OG 5. BK 6. BU</p>
<p>RSM ..A**</p>				

We reserve the right to make technical alterations without prior notice.

Cordsets

* Length in meters. Standard cable lengths are 2, 4, 5, 6, 8 and 10 meters. Consult factory for other lengths.
 ** Standard coupling nut material is nickel plated brass "RKM .."; "RKV .." indicates stainless steel.

- NEMA 1, 3, 4, 6P
- IEC IP67 Protection
- 600 V, 9 A



Connector Style	Female Part Number	Male Part Number	Features	Pinout
<p>RKM ..D**</p>	RKM 26D-*M	RSM 26D-*M	STOOW PVC Yellow 2x16 AWG, 105 °C, 9.6 mm OD, Cable #RF50561-*M, Flexlife®	<p>1. WH 2. BK</p>
	RKM 35D-*M	RSM 35D-*M	STOOW PVC Yellow, 3x16 AWG, 105 °C, 10.0 mm OD, Cable #RF50537-*M, Flexlife	<p>1. GN 2. RD/BK 3. RD/WH</p>
	RKM 36D-*M	RSM 36D-*M	STOOW PVC Yellow, 3x16 AWG, 105 °C, 10.0 mm OD, Cable #RF50536-*M, Flexlife	<p>1. GN 2. BK 3. WH</p>
	RKM 46D-*M	RSM 46D-*M	STOOW PVC Yellow, 4x16 AWG, 105 °C, 10.8 mm OD, Cable #RF50538-*M, Flexlife	<p>1. BK 2. WH 3. RD 4. GN</p>
	RKM 56D-*M	RSM 56D-*M	STOOW PVC Yellow, 5x16 AWG, 105 °C, 12.7 mm OD, Cable #RF50539-*M, Flexlife	<p>1. WH 2. RD 3. GN 4. OG 5. BK</p>
<p>RSM ..D**</p>				<p>Female/Male</p>
				<p>Female</p>
				<p>Male</p>
				<p>Female</p>
				<p>Male</p>
				<p>Female</p>
				<p>Male</p>

We reserve the right to make technical alterations without prior notice.

* Length in meters. Standard cable lengths are 2, 4, 5, 6, 8 and 10 meters. Consult factory for other lengths.

** Standard coupling nut material is nickel plated brass "RKM .."; "RKV .." indicates stainless steel.

3 and 5-Wire Spiral Cordsets, Standard

- NEMA 1, 3, 4, 6P
- IEC IP67 Protection
- 300 V, 9 A



We reserve the right to make technical alterations without prior notice.

Connector Style	Female Part Number	Male Part Number	Features	Pinout
<p>RKM ..**</p>	<p>RKM 30-2M/S90-SP WKM 30-2M/S90-SP</p>	<p>RSM 30-2M/S90-SP WSM 30-2M/S90-SP</p>	<p>AWM TPU Yellow 3x18 AWG, 90 °C, 300 V, 9 A, 7.2 mm OD, for repetitive 2-wire AC with ground or 3-wire applications</p>	<p>Female</p>
<p>WKM ..**</p>				<p>Male</p>
<p>RSM ..**</p>	<p>RKM 50-1M/S90-SP WKM 50-1M/S90-SP</p>	<p>RSM 50-1M/S90-SP WSM 50-1M/S90-SP</p>	<p>AWM TPU Yellow 5x18 AWG, 90 °C, 300 V, 9 A, 7.2 mm OD, for repetitive 5-wire AC applications</p>	<p>Female</p>
<p>WSM ..**</p>				<p>Male</p>

Standard cable lengths are 2 (3-wire) and 1 (5-wire) meters. Consult factory for other lengths.
 ** Standard coupling nut material is nickel plated brass "RKM .."; "RKV .." indicates stainless steel.

Cordsets

- NEMA 1, 3, 4, 6P
- IEC IP67 Protection
- Polypropylene Contact Holder, Mold Material and Cable Jacket
- High Chemical Solvent Resistance & Tensile Strength



Connector Style	Female Part Number	Male Part Number	Features	Pinout
<p>WD-RKV ..**</p>	WD-RKV 20-*M WD-WKV 20-*M	WD-RSV 20-*M WD-WSV 20-*M	PP White, 2x18 AWG, 105 °C, 300 V, 9 A, 5.1 mm OD, Cable #RF51441-*M	Female 1. BN 2. BU
	WD-RKV 26-*M WD-WKV 26-*M	WD-RSV 26-*M WD-WSV 26-*M	PP White, 2x16 AWG, 105 °C, 600 V, 10 A, 6.2 mm OD, Cable #RF51442-*M	Female 1. WH 2. BK
<p>WD-WKV ..**</p>	WD-RKV 30-*M WD-WKV 30-*M	WD-RSV 30-*M WD-WSV 30-*M	PP White, 3x18 AWG, 105 °C, 300 V, 9 A, 5.7 mm OD, Cable #RF51443-*M	Female 1. GN/YE 2. BN 3. BU
	WD-RKV 36-*M WD-WKV 36-*M	WD-RSV 36-*M WD-WSV 36-*M	PP White, 3x16 AWG, 105 °C, 600 V, 10 A, 7.2 mm OD, Cable #RF51444-*M	Male 1. GN 2. BK 3. WH
<p>WD-RSV ..**</p>	WD-RKV 40-*M WD-WKV 40-*M	WD-RSV 40-*M WD-WSV 40-*M	PP White, 4x18 AWG, 105 °C, 300 V, 9 A, 6.2 mm OD, Cable #RF51445-*M	Female 1. BN 2. WH 3. BU 4. BK
	WD-RKV 46-*M WD-WKV 46-*M	WD-RSV 46-*M WD-WSV 46-*M	PP White, 4x16 AWG, 105 °C, 600 V, 10 A, 7.2 mm OD, Cable #RF51446-*M	Male 1. BK 2. WH 3. RD 4. GN

We reserve the right to make technical alterations without prior notice.

* Length in meters. Standard cable lengths are 2, 4, 5, 6, 8 and 10 meters. Consult factory for other lengths.

** Standard coupling nut material is stainless steel.

5 and 6-Wire Washdown Cordsets

- NEMA 1, 3, 4, 6P
- IEC IP67 Protection
- Polypropylene Contact Holder, Mold Material and Cable Jacket
- High Chemical Solvent Resistance & Tensile Strength





Connector Style	Female Part Number	Male Part Number	Features	Pinout
<p>WD-RKV ..**</p>	<p>WD-RKV 50-*M WD-WKV 50-*M</p>	<p>WD-RSV 50-*M WD-WSV 50-*M</p>	<p>PP White, 5x18 AWG, 105 °C, 300 V, 9 A, 7.2 mm OD, Cable #RF51447-*M</p>	<p>1. BK 2. BU 3. GN/YE 4. BN 5. WH</p> <p>Female</p>
<p>WD-WKV ..**</p>	<p>WD-RKV 56-*M WD-WKV 56-*M</p>	<p>WD-RSV 56-*M WD-WSV 56-*M</p>	<p>PP White, 5x16 AWG, 105 °C, 600 V, 10 A, 7.2 mm OD, Cable #RF51448-*M</p>	<p>1. WH 2. RD 3. GN 4. OG 5. BK</p> <p>Male</p>
<p>WD-RSV ..**</p>	<p>WD-RKV 60-*M WD-WKV 60-*M</p>	<p>WD-RSV 60-*M WD-WSV 60-*M</p>	<p>PP White, 6x18 AWG, 105 °C, 300 V, 8 A, 7.2 mm OD, Cable #RF51449-*M</p>	<p>1. GN 2. WH 3. BU 4. GY 5. YE 6. BN</p> <p>Female</p>
<p>WD-WSV ..**</p>	<p>WD-RKV 66-*M WD-WKV 66-*M</p>	<p>WD-RSV 66-*M WD-WSV 66-*M</p>	<p>PP White, 6x16 AWG, 105 °C, 600 V, 8 A, 8.0 mm OD, Cable #RF51450-*M</p>	<p>1. WH 2. RD 3. GN 4. OG 5. BK 6. BU</p> <p>Male</p>

We reserve the right to make technical alterations without prior notice.

Cordsets

* Length in meters. Standard cable lengths are 2, 4, 5, 6, 8 and 10 meters. Consult factory for other lengths.
 ** Standard coupling nut material is stainless steel.

Mounting Style	Image	Panel Thread Types	Page										
<p>Front Mount</p>		<table border="1"> <tr> <td>1/2-14 NPSM</td> <td>F25</td> </tr> <tr> <td>1/2-14 NPT</td> <td>F29, F36, F38, F40</td> </tr> <tr> <td>M20</td> <td>F32-F35, F41</td> </tr> <tr> <td>3/4-14 NPT</td> <td>F37, F39, F40</td> </tr> <tr> <td>PG16</td> <td>F41</td> </tr> </table>	1/2-14 NPSM	F25	1/2-14 NPT	F29, F36, F38, F40	M20	F32-F35, F41	3/4-14 NPT	F37, F39, F40	PG16	F41	
1/2-14 NPSM	F25												
1/2-14 NPT	F29, F36, F38, F40												
M20	F32-F35, F41												
3/4-14 NPT	F37, F39, F40												
PG16	F41												
<p>Rear Mount</p>		<table border="1"> <tr> <td>M30</td> <td>F42</td> </tr> <tr> <td>Bulkhead Feed-thru</td> <td>F47</td> </tr> </table>	M30	F42	Bulkhead Feed-thru	F47							
M30	F42												
Bulkhead Feed-thru	F47												
<p>PCB Mount</p>		<table border="1"> <tr> <td>PCB Pins</td> <td>F45</td> </tr> </table>	PCB Pins	F45									
PCB Pins	F45												

We reserve the right to make technical alterations without prior notice.

2 and 3-Wire Receptacles, Front Mount, 1/2-14 NPSM Threads

- NEMA 1, 3, 4, 6P
- IEC IP67 Protection



Housing Style	Female Part Number	Male Part Number	Features	Pinout
<p>RKF ..</p> <p>Typical panel cutout 22.5 mm</p> <p>RSF ..</p> <p>Typical panel cutout 22.5 mm</p>	RKF 20-*M	RSF 20-*M	2x18 AWG 105 °C, 600 V, 9 A, standard duty	1. BN 2. BU
	RKF 26-*M	RSF 26-*M	2x16 AWG Leads, 105 °C, 600 V, 10 A, heavy duty	1. WH 2. BK
	RKF 28-*M	RSF 28-*M	2x18 AWG, 105 °C, 600 V, 9 A, heavy duty	1. WH 2. BK
	RKF 30-*M	RSF 30-*M	3x18 AWG, 105 °C, 600 V, 9 A, standard duty	1. GY/YE 2. BN 3. BU
	RKF 31-*M	RSF 31-*M	3x18 AWG, 105 °C, 600 V, 9 A, standard duty	1. BK 2. BN 3. BU
	RKF 311-*M	RSF 311-*M	3x18 AWG, 105 °C, 600 V, 9 A, automotive color code	1. GN 2. RD/BK 3. RD/WH
	RKF 35-*M	RSF 35-*M	3x16 AWG, 105 °C, 600 V, 10 A, automotive color code	
	RKF 36-*M	RSF 36-*M	3x16 AWG, 105 °C, 600 V, 10 A, heavy duty	1. GN 2. BK 3. WH
RKF 38-*M	RSF 38-*M	3x18 AWG, 105 °C, 600 V, 9 A, heavy duty	1. GN 2. BK 3. WH	

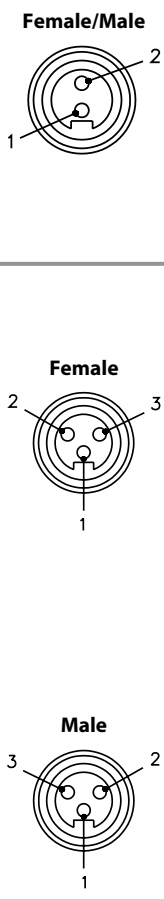

Receptacles

We reserve the right to make technical alterations without prior notice.

Standard lead length is 0.3 meters. Consult factory for other lengths.
 ** Standard housing material is nickel plated brass.. "RSF .."; "RSFV .." indicates stainless steel housing, and "RSFK .." indicates nylon housing.
 For locknuts to be included, add "W/LN" to the end of the part number. To specify PVC jacketed cable, add "/S717" to the end of the part number.

- NEMA 1, 3, 4, 6P
- IEC IP67 Protection



Housing Style	Female Part Number	Male Part Number	Features	Pinout
<p>RKF ..</p> <p>Typical panel cutout 22.5 mm</p>	RKF 40-*M	RSF 40-*M	4x18 AWG 105 °C, 600 V, 9 A, standard duty	<p>Female</p> <p>1. BN 2. WH 3. BU 4. BK</p> <p>Male</p>
	RKF 46-*M	RSF 46-*M	4x16 AWG, 105 °C, 600 V, 10 A, heavy duty	<p>Female</p> <p>1. BK 2. WH 3. RD 4. GN</p> <p>Male</p>
<p>RSF ..</p> <p>Typical panel cutout 22.5 mm</p>	RKF 48-*M	RSF 48-*M	3x18 AWG, 105 °C, 600 V, 9 A, standard duty	<p>Female</p> <p>1. BN 2. N/C 3. BU 4. N/C</p> <p>Male</p>

We reserve the right to make technical alterations without prior notice.

Standard lead length is 0.3 meters. Consult factory for other lengths.

** Standard housing material is nickel plated brass. "RSF .."; "RSFV .." indicates stainless steel housing, and "RSFK .." indicates nylon housing. For locknuts to be included, add "W/LN" to the end of the part number. To specify PVC jacketed cable, add "/S717" to the end of the part number.

5-Wire Receptacles, Front Mount, 1/2-14 NPSM Threads

- NEMA 1, 3, 4, 6P
- IEC IP67 Protection



Housing Style	Female Part Number	Male Part Number	Features	Pinout
<p>RKF ..</p>	RKF 50-*M	RSF 50-*M	5x18 AWG, 105 °C, 600 V, 9 A, standard duty	1. BK 2. BU 3. GN/YE 4. BN 5. WH
	RKF 511-*M	RSF 511-*M	5x18 AWG, 105 °C, 600 V, 9 A, automotive color code	1. RD/WH 2. RD/BU 3. GN 4. RD/OG 5. RD/BK
<p>RSF ..</p>	RKF 55-*M	RSF 55-*M	5x16 AWG, 105 °C, 600 V, 10 A, automotive color code	1. RD/WH 2. RD/BU 3. GN 4. RD/OG 5. RD/BK
	RKF 56-*M	RSF 56-*M	5x16 AWG, 105 °C, 600 V, 10 A, heavy duty	<p>Male</p>
	RKF 58-*M	RSF 58-*M	5x18 AWG, 105 °C, 300 V, 9 A, heavy duty	

We reserve the right to make technical alterations without prior notice.

Receptacles

Standard lead length is 0.3 meters. Consult factory for other lengths.

** Standard housing material is nickel plated brass. "RSF .."; "RSFV .." indicates stainless steel housing, and "RSFK .." indicates nylon housing. For locknuts to be included, add "W/LN" to the end of the part number. To specify PVC jacketed cable, add "/S717" to the end of the part number.

- NEMA 1, 3, 4, 6P
- IEC IP67 Protection



Housing Style	Female Part Number	Male Part Number	Features	Pinout
<p>RKF ..</p> <p>Typical panel cutout 22.5 mm</p>	RKF 61-*M	RSF 61-*M	6x18 AWG, 105 °C, 600 V, 8 A, standard threads	<ol style="list-style-type: none"> GN WH BU Gy YE BN <p>Female</p>
<p>RSF ..</p> <p>Typical panel cutout 22.5 mm</p>	RKF 66-*M	RSF 66-*M	6x16 AWG, 105 °C, 600 V, 8 A, heavy duty	<ol style="list-style-type: none"> WH RD GN OG BK BU <p>Male</p>
<p>RKF ..</p> <p>Typical panel cutout 22.5 mm</p>	RKF 68-*M	RSF 68-*M	6x18 AWG, 105 °C, 600 V, 8 A, heavy duty	

Standard lead length is 0.3 meters. Consult factory for other lengths.

** Standard housing material is nickel plated brass. "RSF .."; "RSFV .." indicates stainless steel housing, and "RSFK .." indicates nylon housing. For locknuts to be included, add "W/LN" to the end of the part number. To specify PVC jacketed cable, add "/S717" to the end of the part number.

We reserve the right to make technical alterations without prior notice.

2 and 3-Wire Receptacles, Front Mount, 1/2-14 NPT Threads

- NEMA 1, 3, 4, 6P
- IEC IP67 Protection



Housing Style	Female Part Number	Male Part Number	Features	Pinout
<p>RKF ..NPT</p> <p>Typical panel cutout 22.5 mm</p> <p>RSF ..NPT</p> <p>Typical panel cutout 22.5 mm</p>	RKF 20-*M/NPT	RSF 20-*M/NPT	2x18 AWG, 105 °C, 9 A, standard duty	1. BN 2. BU
	RKF 26-*M/NPT	RSF 26-*M/NPT	2x16 AWG Leads, 105 °C, 10 A, heavy duty	1. WH 2. BK
	RKF 28-*M/NPT	RSF 28-*M/NPT	2x18 AWG, 105 °C, 600 V, 9 A, heavy duty	1. WH 2. BK
	RKF 30-*M/NPT	RSF 30-*M/NPT	3x18 AWG, 105 °C, 9 A, standard duty	1. GY/YE 2. BN 3. BU
	RKF 31-*M/NPT	RSF 31-*M/NPT	3x18 AWG, 105 °C, 9 A, standard duty	1. BK 2. BN 3. BU
	RKF 311-*M/NPT	RSF 311-*M/NPT	3x18 AWG, 105 °C, 9 A, automotive color code	1. GN 2. RD/BK 3. RD/WH
	RKF 35-*M/NPT	RSF 35-*M/NPT	3x16 AWG, 105 °C, 10 A, automotive color code	
	RKF 36-*M/NPT	RSF 36-*M/NPT	3x16 AWG, 105 °C, 10 A, heavy duty	1. GN 2. BK 3. WH
RKF 38-*M/NPT	RSF 38-*M/NPT	3x18 AWG, 105 °C, 600 V, 9 A, heavy duty	1. GN 2. BK 3. WH	

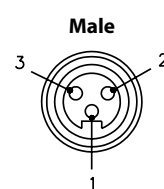
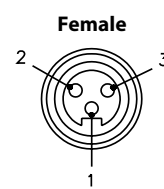
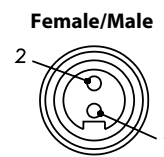

Receptacles

We reserve the right to make technical alterations without prior notice.

Standard lead length is 0.3 meters. Consult factory for other lengths.

** Standard housing material is nickel plated brass.. "RSF .."; "RSFV .." indicates stainless steel housing, and "RSFK .." indicates nylon housing. For locknuts to be included, add "W/LN" to the end of the part number. To specify PVC jacketed cable, add "/S717" to the end of the part number.

- NEMA 1, 3, 4, 6P
- IEC IP67 Protection
- 600 V



Housing Style	Female Part Number	Male Part Number	Features	Pinout
<p>RKF ..NPT</p> <p>Typical panel cutout 22.5 mm</p>	RKF 40-*M/NPT	RSF 40-*M/NPT	4x18 AWG, 105 °C, 9 A, standard duty	<p>Female</p> <p>Male</p>
	RKF 46-*M/NPT	RSF 46-*M/NPT	4x16 AWG, 105 °C, 10 A, heavy duty	<p>Female</p> <p>Male</p>
<p>RSF ..NPT</p> <p>Typical panel cutout 22.5 mm</p>	RKF 48A-*M/NPT	RSF 48A-*M/NPT	4x18 AWG, 105 °C, 9 A, heavy duty	<p>Female</p> <p>Male</p>

We reserve the right to make technical alterations without prior notice.

Standard lead length is 0.3 meters. Consult factory for other lengths.

** Standard housing material is nickel plated brass. "RSF .."; "RSFV .." indicates stainless steel housing, and "RSFK .." indicates nylon housing. For locknuts to be included, add "W/LN" to the end of the part number. To specify PVC jacketed cable, add "/S717" to the end of the part number.

5 and 6-Wire Receptacles, Front Mount, 1/2-14 NPT Threads

- NEMA 1, 3, 4, 6P
- IEC IP67 Protection
- 600 V



Housing Style	Female Part Number	Male Part Number	Features	Pinout
<p>RKF ..NPT</p> <p>Typical panel cutout 22.5 mm</p>	RKF 50-*M/NPT	RSF 50-*M/NPT	5x18 AWG, 105 °C, 9 A, standard duty	1. BK 2. BU 3. GN/YE 4. BN 5. WH
	RKF 511-*M/NPT	RSF 511-*M/NPT	5x18 AWG, 105 °C, 9 A, automotive color code	1. RD/WH 2. RD/BU 3. GN 4. RD/OG 5. RD/BK
	RKF 55-*M/NPT	RSF 55-*M/NPT	5x16 AWG, 105 °C, 10 A, automotive color code	1. WH 2. RD 3. GN 4. OG 5. BK
	RKF 56-*M/NPT	RSF 56-*M/NPT	5x16 AWG, 105 °C, 10 A, heavy duty	1. GN 2. WH 3. BU 4. GY 5. YE 6. BN
	RKF 58-*M/NPT	RSF 58-*M/NPT	5x18 AWG, 105 °C, 300 V, 9 A, heavy duty	1. WH 2. RD 3. GN 4. OG 5. BK
<p>RSF ..NPT</p> <p>Typical panel cutout 22.5 mm</p>	RKF 61-*M/NPT	RSF 61-*M/NPT	6x18 AWG, 105 °C, 8 A, standard duty	1. GN 2. WH 3. BU 4. GY 5. YE 6. BN
	RKF 66-*M/NPT	RSF 66-*M/NPT	6x16 AWG, 105 °C, 8 A, heavy duty	1. WH 2. RD 3. GN 4. OG 5. BK 6. BU
	RKF 68-*M/NPT	RSF 68-*M/NPT	6x18 AWG, 105 °C, 600 V, 8 A, heavy duty	1. GN 2. WH 3. BU 4. GY 5. YE 6. BN

We reserve the right to make technical alterations without prior notice.

Standard lead length is 0.3 meters. Consult factory for other lengths.

** Standard housing material is nickel plated brass.. "RSF .."; "RSFV .." indicates stainless steel housing, and "RSFK .." indicates nylon housing. For locknuts to be included, add "W/LN" to the end of the part number. To specify PVC jacketed cable, add "/S717" to the end of the part number.

Receptacles

- NEMA 1, 3, 4, 6P
- IEC IP67 Protection
- 600 V



Housing Style	Female Part Number	Male Part Number	Features	Pinout
<p>RKF ..M20</p> <p>Typical panel cutout 22.5 mm</p>	RKF 20-*M/M20	RSF 20-*M/M20	2x18 AWG, 105 °C, 9 A, standard duty	1. BN 2. BU
	RKF 26-*M/M20	RSF 26-*M/M20	2x16 AWG Leads, 105 °C, 10 A, heavy duty	1. WH 2. BK
	RKF 30-*M/M20	RSF 30-*M/M20	3x18 AWG, 105 °C, 9 A standard duty	1. GY/YE 2. BN 3. BU
	RKF 31-*M/M20	RSF 31-*M/M20	3x18 AWG, 105 °C, 9 A standard duty	1. BK 2. BN 3. BU
	RKF 311-*M/M20	RSF 311-*M/M20	3x18 AWG, 105 °C, 9 A automotive color code	1. GN 2. RD/BK 3. RD/WH
	RKF 35-*M/M20	RSF 35-*M/M20	3x16 AWG, 105 °C, 10 A, automotive color code	
	RKF 36-*M/M20	RSF 36-*M/M20	3x16 AWG, 105 °C, 10 A, heavy duty	1. GN 2. BK 3. WH
<p>RSF ..M20</p> <p>Typical panel cutout 22.5 mm</p>	RKF 40-*M/M20	RSF 40-*M/M20	4x18 AWG, 105 °C, 9 A standard duty	1. BN 2. WH 3. BU 4. BK
	RKF 46-*M/M20	RSF 46-*M/M20	4x16 AWG, 105 °C, 10 A heavy duty	1. BK 2. WH 3. RD 4. GN

We reserve the right to make technical alterations without prior notice.

Standard lead length is 0.3 meters. Consult factory for other lengths.

** Standard housing material is nickel plated brass.. "RSF .."; "RSFV .." indicates stainless steel housing, and "RSFK .." indicates nylon housing.

For locknuts to be included, add "W/LN" to the end of the part number. To specify PVC jacketed cable, add "/S717" to the end of the part number.

5 and 6-Wire Receptacles, Front Mount, M20 Threads

- NEMA 1, 3, 4, 6P
- IEC IP67 Protection
- 600 V



Housing Style	Female Part Number	Male Part Number	Features	Pinout	
<p>RKF ..M20</p> <p>Typical panel cutout 22.5 mm</p>	RKF 50-*M/M20	RSF 50-*M/M20	5x18 AWG, 105 °C, 9 A standard duty	1. BK 2. BU 3. GN/YE 4. BN 5. WH 	
	RKF 511-*M/M20	RSF 511-*M/M20	5x18 AWG, 105 °C, 9 A automotive color code	1. RD/WH 2. RD/BU 3. GN 4. RD/OG 5. RD/BK 	
	RKF 55-*M/M20	RSF 55-*M/M20	5x16 AWG, 105 °C, 10 A, automotive color code	1. WH 2. RD 3. GN 4. OG 5. BK 	
	RKF 56-*M/M20	RSF 56-*M/M20	5x16 AWG, 105 °C, 10 A, heavy duty	1. WH 2. RD 3. GN 4. OG 5. BK 	
	<p>RSF ..M20</p> <p>Typical panel cutout 22.5 mm</p>	RKF 61-*M/M20	RSF 61-*M/M20	6x18 AWG, 105 °C, 8 A standard duty	1. GN 2. WH 3. BU 4. GY 5. YE 6. BN
		RKF 66-*M/M20	RSF 66-*M/M20	6x16 AWG, 105 °C, 8 A heavy duty	1. WH 2. RD 3. GN 4. OG 5. BK 6. BU

We reserve the right to make technical alterations without prior notice.

Receptacles

Standard lead length is 0.3 meters. Consult factory for other lengths.

** Standard housing material is nickel plated brass.. "RSF .."; "RSFV .." indicates stainless steel housing, and "RSFK .." indicates nylon housing. For locknuts to be included, add "W/LN" to the end of the part number. To specify PVC jacketed cable, add "/S717" to the end of the part number.

- NEMA 1, 3, 4, 6P
- IEC IP68 Protection
- 600 V, 8 A



Housing Style	Female Part Number	Male Part Number	Features	Pinout
<p>RKF ..M20</p> <p>Typical panel cutout 22.5 mm</p>	RKF 6B6-*M/M20	RSF 6B6-*M/M20	6x16 AWG, 105 °C	<p>Female</p> <p>Male</p>
<p>RSF ..M20</p> <p>Typical panel cutout 22.5 mm</p>	RKF 76-*M/M20	RSF 76-*M/M20	7x16 AWG, 105 °C	<p>Female</p> <p>Male</p>
<p>RSF ..M20</p> <p>Typical panel cutout 22.5 mm</p>	RKF 86-*M/M20	RSF 86-*M/M20	8x16 AWG, 105 °C	<p>Female</p> <p>Male</p>

We reserve the right to make technical alterations without prior notice.

Standard lead length is 0.3 meters. Consult factory for other lengths.

** Standard housing material is nickel plated brass.. "RSF .."; "RSFV .." indicates stainless steel housing, and "RSFK .." indicates nylon housing.
 For locknuts to be included, add "W/LN" to the end of the part number. To specify PVC jacketed cable, add "/S717" to the end of the part number.

9, 10 and 12-Wire Receptacles, Front Mount, M20 Threads

- NEMA 1, 3, 4, 6P
- IEC IP68 Protection
- 600 V, 7 A



We reserve the right to make technical alterations without prior notice.

Housing Style	Female Part Number	Male Part Number	Features	Pinout
<p>RKF ..M20 Typical panel cutout 22.5 mm</p>	RKF 96-*M/M20	RSF 96-*M/M20	9x16 AWG, 105 °C	<p>Female</p> <p>Male</p>
<p>RKF 106-*M/M20 Typical panel cutout 22.5 mm</p>	RKF 106-*M/M20	RSF 106-*M/M20	10x16 AWG, 105 °C	<p>Female</p> <p>Male</p>
<p>RKF 126-*M/M20 Typical panel cutout 22.5 mm</p>	RKF 126-*M/M20	RSF 126-*M/M20	12x16 AWG, 105 °C	<p>Female</p> <p>Male</p>

Receptacles

Standard lead length is 0.3 meters. Consult factory for other lengths.

** Standard housing material is nickel plated brass.. "RSF .."; "RSFV .." indicates stainless steel housing, and "RSFK .." indicates nylon housing.
For locknuts to be included, add "W/LN" to the end of the part number. To specify PVC jacketed cable, add "/S717" to the end of the part number.

- NEMA 1, 3, 4, 6P
- IEC IP68 Protection
- 600 V, 8 A



Housing Style	Female Part Number	Male Part Number	Features	Pinout
<p>RKF ..1/2-14NPT</p> <p>Typical panel cutout 22.5 mm</p>	RKF 6B6-*M/14.5/NPT	RSF 6B6-*M/14.5/NPT	6x16 AWG, 105 °C, 1/2-14 NPT threads	<p>Female</p> <p>Male</p>
	RKF 76-*M/14.5/NPT	RSF 76-*M/14.5/NPT	7x16 AWG, 105 °C, 1/2-14 NPT threads	<p>Female</p> <p>Male</p>
<p>RSF ..1/2-14NPT</p> <p>Typical panel cutout 22.5 mm</p>	RKF 86-*M/14.5/NPT	RSF 86-*M/14.5/NPT	8x16 AWG, 105 °C, 1/2-14 NPT threads	<p>Female</p> <p>Male</p>

We reserve the right to make technical alterations without prior notice.

Standard lead length is 0.3 meters. Consult factory for other lengths.

** Standard housing material is nickel plated brass.. "RSF .."; "RSFV .." indicates stainless steel housing, and "RSFK .." indicates nylon housing.

For locknuts to be included, add "W/LN" to the end of the part number. To specify PVC jacketed cable, add "/S717" to the end of the part number.

6, 7 and 8-Wire Receptacles, Front Mount

- NEMA 1, 3, 4, 6P
- IEC IP68 Protection
- 600 V, 8 A



We reserve the right to make technical alterations without prior notice.

Housing Style	Female Part Number	Male Part Number	Features	Pinout
<p>RKF ..3/4-14NPT</p> <p>Typical panel cutout 22.5 mm</p>	RKF 6B6-*M/14.75/NPT	RSF 6B6-*M/14.75/NPT	6x16 AWG, 105 °C, 3/4-14 NPT threads	<p>Female</p> <p>Male</p>
<p>RSF ..3/4-14NPT</p> <p>Typical panel cutout 22.5 mm</p>	RKF 76-*M/14.75/NPT	RSF 76-*M/14.75/NPT	7x16 AWG, 105 °C, 3/4-14 NPT threads	<p>Female</p> <p>Male</p>
<p>RSF ..3/4-14NPT</p> <p>Typical panel cutout 22.5 mm</p>	RKF 86-*M/14.75/NPT	RSF 86-*M/14.75/NPT	8x16 AWG, 105 °C, 3/4-14 NPT threads	<p>Female</p> <p>Male</p>

Receptacles

Standard lead length is 0.3 meters. Consult factory for other lengths.

** Standard housing material is nickel plated brass.. "RSF .."; "RSFV .." indicates stainless steel housing, and "RSFK .." indicates nylon housing.
For locknuts to be included, add "W/LN" to the end of the part number. To specify PVC jacketed cable, add "/S717" to the end of the part number.

1 1/8" minifast® Connectivity Products

9, 10 and 12-Wire Receptacles, Front Mount



- NEMA 1, 3, 4, 6P
- IEC IP68 Protection
- 600 V, 7 A



Housing Style	Female Part Number	Male Part Number	Features	Pinout
<p>RKF ...1/2-14NPT</p> <p>Typical panel cutout 22.5 mm</p>	RKF 96-*M/14.5/NPT	RSF 96-*M/14.5/NPT	9x16 AWG, 105 °C, 1/2-14 NPT threads	<p>Female</p> <p>1. OG 2. BU 3. RD/BK 4. GN/BK 5. WH 6. RD 7. GN</p> <p>Male</p> <p>4. GN/BK 8. WH/BK 9. BK</p>
<p>RKF 106-*M/14.5/NPT</p> <p>Typical panel cutout 22.5 mm</p>	RKF 106-*M/14.5/NPT	RSF 106-*M/14.5/NPT	10x16 AWG, 105 °C, 1/2-14 NPT threads	<p>Female</p> <p>1. OG 2. BU 3. WH/BK 4. RD/BK 5. GN/BK 6. OG/BK 7. RD 8. GN 9. BK 10. WH</p> <p>Male</p>
<p>RSF ..1/2-14NPT</p> <p>Typical panel cutout 22.5 mm</p>	RKF 126-*M/14.5/NPT	RSF 126-*M/14.5/NPT	12x16 AWG, 105 °C, 1/2-14 NPT threads	<p>Female</p> <p>1. OG 2. BU 3. WH/BK 4. RD/BK 5. GN/BK 6. OG/BK 7. BU/BK 8. BK/WH 9. GN 10. RD 11. WH 12. BK</p> <p>Male</p>

We reserve the right to make technical alterations without prior notice.

Standard lead length is 0.3 meters. Consult factory for other lengths.

** Standard housing material is nickel plated brass.. "RSF .."; "RSFV .." indicates stainless steel housing, and "RSFK .." indicates nylon housing.

For locknuts to be included, add "W/LN" to the end of the part number. To specify PVC jacketed cable, add "/S717" to the end of the part number.

9, 10 and 12-Wire Receptacles, Front Mount

- NEMA 1, 3, 4, 6P
- IEC IP68 Protection
- 600 V, 7 A



We reserve the right to make technical alterations without prior notice.

Housing Style	Female Part Number	Male Part Number	Features	Pinout
<p>RKF ..3/4-14NPT</p> <p>Typical panel cutout 22.5 mm</p>	RKF 96-*M/14.75/NPT	RSF 96-*M/14.75/NPT	9x16 AWG, 105 °C, 3/4-14 NPT threads	<p>Female</p> <p>1. OG 2. BU 3. RD/BK 4. GN/BK 5. WH 6. RD 7. GN 8. WH/BK 9. BK</p> <p>Male</p>
	RKF 106-*M/14.75/NPT	RSF 106-*M/14.75/NPT	10x16 AWG, 105 °C, 3/4-14 NPT threads	<p>Female</p> <p>1. OG 2. BU 3. WH/BK 4. RD/BK 5. GN/BK 6. OG/BK 7. RD 8. GN 9. BK 10. WH</p> <p>Male</p>
<p>RSF ..3/4-14NPT</p> <p>Typical panel cutout 22.5 mm</p>	RKF 126-*M/14.75/NPT	RSF 126-*M/14.75/NPT	12x16 AWG, 105 °C, 3/4-14 NPT threads	<p>Female</p> <p>1. OG 2. BU 3. WH/BK 4. RD/BK 5. GN/BK 6. OG/BK 7. BU/BK 8. BK/WH 9. GN 10. RD 11. WH 12. BK</p> <p>Male</p>

Receptacles

Standard lead length is 0.3 meters. Consult factory for other lengths.

** Standard housing material is nickel plated brass.. "RSF .."; "RSFV .." indicates stainless steel housing, and "RSFK .." indicates nylon housing.
For locknuts to be included, add "W/LN" to the end of the part number. To specify PVC jacketed cable, add "/S717" to the end of the part number.

- NEMA 1, 3, 4, 6P
- IEC IP68 Protection
- 300 V, 4 A (pins 5, 7, 12), 2 A (all others)



Housing Style	Female Part Number	Male Part Number	Features	Pinout
<p>RSF ..1/2-14NPT</p> <p>Typical panel cutout 22.5 mm</p>	RKF 190-*M/14.5/NPT	RSF 190-*M/14.5/NPT	3x18, 16x22 AWG, 105 °C, 1/2-14 NPT threads	<p>Female</p> <p>1. VT 2. RD 3. GY 4. RD/BU 5. BU 6. GN 7. BN 8. WH/GN 9. WH/YE 10. WH/GY 11. BK 12. GN/YE 13. YE/BN 14. BN/GN 15. WH 16. YE 17. PK 18. GY/BN 19. GY/PK</p>
<p>RKF ...1/2-14NPT</p> <p>Typical panel cutout 22.5 mm</p>				
<p>RSF ..3/4-14NPT</p> <p>Typical panel cutout 22.5 mm</p>	RKF 190-*M/14.75/NPT	RSF 190-*M/14.75/NPT	3x18, 16x22 AWG 105 °C, 3/4-14 NPT threads	<p>Male</p>
<p>RKF ..3/4-14NPT</p> <p>Typical panel cutout 22.5 mm</p>				

We reserve the right to make technical alterations without prior notice.

Standard lead length is 0.3 meters. Consult factory for other lengths.

** Standard housing material is nickel plated brass. "RSF .."; "RSFV .." indicates stainless steel housing, and "RSFK .." indicates nylon housing. For locknuts to be included, add "W/LN" to the end of the part number. To specify PVC jacketed cable, add "/S717" to the end of the part number.

19-Wire Receptacles, Front Mount

- NEMA 1, 3, 4, 6P
- IEC IP68 Protection
- 300 V, 4 A (pins 5, 7, 12), 2 A (all others)



We reserve the right to make technical alterations without prior notice.

Housing Style	Female Part Number	Male Part Number	Features	Pinout
<p>RKF ..PG16</p> <p>Typical panel cutout 22.5 mm</p>	<p>RKF 190-*M/PG 16</p>	<p>RSF 190-*M/PG 16</p>	<p>3x18, 16x22 AWG, 105 °C, PG 16 threads</p>	<p>Female</p> <p>1. VT 2. RD 3. GY 4. RD/BU 5. BU 6. GN 7. BN 8. WH/GN 9. WH/YE 10. WH/GY 11. BK 12. GN/YE 13. YE/BN 14. BN/GN 15. WH 16. YE 17. PK 18. GY/BN 19. GY/PK</p>
<p>RSF ..PG16</p> <p>Typical panel cutout 22.5 mm</p>				
<p>RKF ...M20</p> <p>Typical panel cutout 22.5 mm</p>	<p>RKF 190-*M/M20</p>	<p>RSF 190-*M/M20</p>	<p>3x18, 16x22 AWG, 105 °C, M20 threads</p>	<p>Male</p>
<p>RSF ..M20</p> <p>Typical panel cutout 22.5 mm</p>				

Standard lead length is 0.3 meters. Consult factory for other lengths.

** Standard housing material is nickel plated brass. "RSF .."; "RSFV .." indicates stainless steel housing, and "RSFK .." indicates nylon housing.

For locknuts to be included, add "W/LN" to the end of the part number. To specify PVC jacketed cable, add "/S717" to the end of the part number.

Receptacles

- NEMA 1, 3, 4, 6P
- IEC IP68 Protection
- 600 V



Housing Style	Female Part Number	Male Part Number	Features	Pinout
<p>RKFP ..</p> <p>RKFP Cutout</p> <p>Recommended maximum panel thickness is 6.4 mm</p>	RKFP 20-*M	RSFP 20-*M	2x18 AWG, 105 °C, 9 A, M30x1.5 threads, standard duty	1. BN 2. BU Female/Male
	RKFP 26-*M	RSFP 26-*M	2x16 AWG, 105 °C, 10 A, M30x1.5 threads, heavy duty	1. WH 2. BK
	RKFP 30-*M	RSFP 30-*M	3x18 AWG, 105 °C, 9 A, M30x1.5 threads, standard duty	1. GN/YE 2. BN 3. BU
<p>RSFP ..</p> <p>RSFP Cutout</p> <p>Recommended maximum panel thickness is 6.4 mm</p>	RKFP 31-*M	RSFP 31-*M	3x18 AWG, 105 °C, 9 A, M30x1.5 threads, standard duty	Female
	RKFP 311-*M	RSFP 311-*M	3x18 AWG, 105 °C, 9 A, M30x1.5 threads, automotive color code	1. GN 2. RD/BK 3. RD/WH
	RKFP 35-*M	RSFP 35-*M	3x16 AWG, 105 °C, 10 A, automotive color code, M30x1.5 Threads	Male
	RKFP 36-*M	RSFP 36-*M	3x16 AWG, 105 °C, 10 A, M30x1.5 threads, heavy duty	1. GN 2. BK 3. WH

We reserve the right to make technical alterations without prior notice.

Standard lead length is 0.3 meters. Consult factory for other lengths.

** Standard housing material is nickel plated brass.. "RSFP .."; "RSFPV .." indicates stainless steel housing.
To specify PVC jacketed cable, add "/S717" to the end of the part number.

4-Wire Receptacles, Back Panel Mount

- NEMA 1, 3, 4, 6P
- IEC IP68 Protection
- 600 V



Housing Style	Female Part Number	Male Part Number	Features	Pinout
<p>RKFP ..</p> <p>RKFP Cutout</p> <p>Recommended maximum panel thickness is 6.4 mm</p>	RKFP 40-*M	RSFP 40-*M	4x18 AWG, 105 °C, 9 A, M30x1.5 Threads, Standard Duty	<p>Female</p> <p>Male</p>
<p>RSFP ..</p> <p>RSFP Cutout</p> <p>Recommended maximum panel thickness is 6.4 mm</p>	RKFP 46-*M	RSFP 46-*M	4x16 AWG, 105 °C, 10 A, M30x1.5 Threads, Heavy Duty	<p>Female</p> <p>Male</p>

We reserve the right to make technical alterations without prior notice.

Receptacles

Standard lead length is 0.3 meters. Consult factory for other lengths.

** Standard housing material is nickel plated brass.. "RSFP .."; "RSFPV .." indicates stainless steel housing.
To specify PVC jacketed cable, add "/S717" to the end of the part number.

- NEMA 1, 3, 4, 6P
- IEC IP68 Protection
- 600 V



Housing Style	Female Part Number	Male Part Number	Features	Pinout
<p>RKFP ..</p> <p>RKFP Cutout</p> <p>Recommended maximum panel thickness is 6.4 mm</p>	RKFP 50-*M	RSFP 50-*M	5x18 AWG, 105 °C, 9 A, M30x1.5 Threads, Standard Duty	<ol style="list-style-type: none"> 1. BK 2. BU 3. GN/YE 4. BN 5. WH <p>Female</p>
	RKFP 511-*M	RSFP 511-*M	5x18 AWG, 105 °C, 9 A, Automotive Color Code, M30x1.5 Threads	<ol style="list-style-type: none"> 1. RD/WH 2. RD/BU 3. GN 4. RD/OG 5. RD/BK
	RKFP 55-*M	RSFP 55-*M	5x16 AWG, 105 °C, 10 A, Automotive Color Code, M30x1.5 Threads	<p>Male</p>
<p>RSFP ..</p> <p>RSFP Cutout</p> <p>Recommended maximum panel thickness is 6.4 mm</p>	RKFP 61-*M	RSFP 61-*M	6x18 AWG, 105 °C, 8 A, M30x1.5 Threads, Standard Duty	<ol style="list-style-type: none"> 1. GN 2. WH 3. BU 4. GY 5. YE 6. BN <p>Female</p>
	RKFP 66-*M	RSFP 66-*M	6x16 AWG 105 °C, 8 A, M30x1.5 Threads, Heavy Duty	<ol style="list-style-type: none"> 1. WH 2. RD 3. GN 4. OG 5. BK 6. BU
	RKFP 68-*M	RSFP 68-*M	6x18 AWG 105 °C, 8 A, M30x1.5 Threads, Heavy Duty	<p>Male</p>

We reserve the right to make technical alterations without prior notice.

Standard lead length is 0.3 meters. Consult factory for other lengths.

** Standard housing material is nickel plated brass.. "RSFP .."; "RSFPV .." indicates stainless steel housing. To specify PVC jacketed cable, add "/S717" to the end of the part number.

PCB Pins Receptacles

- NEMA 1, 3, 4, 6P
- IEC IP67 Protection
- 600 V, 9 A



Housing Style	Female Part Number	Male Part Number	Features	Pinout
<p>RKF ..PCB</p>	RKF 40-PCB	RSF 40-PCB	4-pin PCB Pins, 105 °C, PG 11 Threads	<p>Female</p> <p>Male</p>
<p>RSF ..PCB</p>	RKF 50-PCB	RSF 50-PCB	5-pin PCB Pins, 105 °C, PG 11 Threads	<p>Female</p> <p>Male</p>

We reserve the right to make technical alterations without prior notice.

Receptacles

** Standard housing material is nickel plated brass. "RSFL .."; "RSFVL .." indicates stainless steel housing. No stainless option for "PCB". For locknuts to be included, add "W/LN" to the end of the part number.

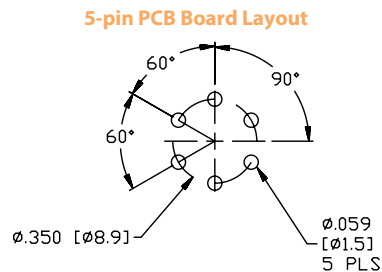
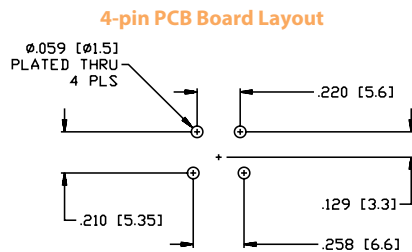

Solder Cup Receptacles

- NEMA 1, 3, 4, 6P
- IEC IP67 Protection
- 600 V, 9 A



Housing Style	Female Part Number	Male Part Number	Features	Pinout
	RKFL 26	RSFL 26	2-pin solder cups, 105 °C, 1/2-14 NPSM Threads	Female/Male
	RKFL 36	RSFL 36	3-pin solder cups, 105 °C, 1/2-14 NPSM Threads	Female Male
	RKFL 46	RSFL 46	4-pin solder cups 105 °C, 1/2-14 NPSM Threads	Female Male
	RKFL 56	RSFL 56	5-pin solder cups 105 °C, 1/2-14 NPSM Threads	Female Male
	RKFL 66	RSFL 66	6-pin solder cups 105 °C, 1/2-14 NPSM Threads	Female Male

We reserve the right to make technical alterations without prior notice.

** Standard housing material is nickel plated brass.. "RSFL .."; "RSFVL .." indicates stainless steel housing. No stainless option for "PCB".
For locknuts to be included, add "W/LN" to the end of the part number.

4-pin PCB Board Layout

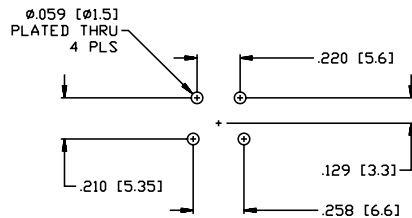

5-pin PCB Board Layout

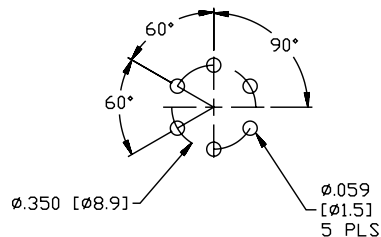

Bulkhead Feed-Thru Receptacles

- NEMA 1, 3, 4, 6P
- IEC IP67 Protection
- 600 V, 9 A



Housing Style	Part Number	Features	Pinout	
<p>Note: Recommended maximum panel thickness is 22.2 mm</p>	RSF RKF 20/22	Nickel plated brass 2-pin, 105 °C, thrust washer and panel keyway prevent rotation	Female 	Male
	RSF RKF 30/22	Nickel plated brass 3-pin, 105 °C, thrust washer and panel keyway prevent rotation	Female 	Male
	RSF RKF 40/22	Nickel plated brass 4-pin, 105 °C, thrust washer and panel keyway prevent rotation	Female 	Male
	RSF RKF 50/22	Nickel plated brass 5-pin, 105 °C, thrust washer and panel keyway prevent rotation	Female 	Male
	RSF RKF 60/22	Nickel plated brass 6-pin, 105 °C, thrust washer and panel keyway prevent rotation	Female 	Male

We reserve the right to make technical alterations without prior notice.

Receptacles

** Standard housing material is nickel plated brass .. "RSF RKF.."; "RSFV RKFV.." indicates stainless steel housing.

- NEMA 1, 3, 4, 6P
- IEC IP67 Protection



Housing Style	Female Part Number	Male Part Number	Features	Pinout
<p>B 41 ..</p>	<p>B 4131-0/9 B 4231-0/9</p>	<p>BS 4131-0/9 BS 4231-0/9</p>	<p>Glass filled nylon, PG 9 cable gland, accepts 6-8 mm cable diameter screw terminals, accepts up to 16 AWG conductors, 85 °C, 250 V, 12 A, Mates with all 3-pin cordsets and receptacles</p>	<p>Female</p>
<p>B 42 ..</p>	<p>B 4131-0/13.5</p>	<p>BS 4131-0/13.5</p>	<p>Glass filled nylon, PG 13.5 cable gland, accepts 10-12 mm cable diameter screw terminals, accepts up to 16 AWG conductors, 85 °C, 250 V, 12 A, Mates with all 3-pin cordsets and receptacles</p>	<p>Male</p>
<p>B 41 ..</p>	<p>B 4141-0/9 B 4241-0/9</p>	<p>BS 4141-0/9 BS 4241-0/9</p>	<p>Glass filled nylon, PG 9 cable gland, accepts 6-8 mm cable diameter screw terminals, accepts up to 16 AWG conductors 85 °C, 250 V, 9 A, Mates with all 4-pin cordsets and receptacles</p>	<p>Female</p>
<p>BS 41 ..</p>	<p>B 4141-0/13.5</p>	<p>BS 4141-0/13.5</p>	<p>Glass filled nylon, PG 13.5 cable gland, accepts 10-12 mm cable diameter screw terminals, accepts up to 16 AWG conductors, 85 °C, 250 V, 9 A, Mates with all 4-pin cordsets and receptacles</p>	<p>Male</p>
<p>B 41 ..</p>	<p>B 4151-0/9 B 4251-0/9</p>	<p>BS 4151-0/9 BS 4251-0/9</p>	<p>Glass filled nylon, PG 9 cable gland, accepts 6-8 mm cable diameter, screw terminals, accepts up to 16 AWG conductors, 85 °C, 250 V, 9 A, Mates with all 5-pin cordsets and receptacles</p>	<p>Female</p>
<p>BS 42 ..</p>	<p>B 4151-0/13.5</p>	<p>BS 4151-0/13.5</p>	<p>Glass filled nylon, PG 13.5 cable gland, accepts 10-12 mm cable diameter screw terminals, accepts up to 16 AWG conductors, 85 °C, 250 V, 9 A</p>	<p>Male</p>
<p>B 41 ..</p>	<p>B 4151-0/16</p>	<p>BS 4151-0/16</p>	<p>Glass filled nylon, PG 16 cable gland, accepts 12-14 mm cable diameter screw terminals, accepts up to 16 AWG conductors, 85 °C, 250 V, 9 A</p>	<p>Male</p>

We reserve the right to make technical alterations without prior notice.

6, 7 and 8-Pin Field Wireable Connectors

- IEC IP67 Protection



We reserve the right to make technical alterations without prior notice.

Housing Style	Female Part Number	Male Part Number	Features	Pinout
<p>B 71..</p>	B 716B61-0/21	BS 716B61-0/21	Glass filled nylon, PG 21 cable gland, accepts 9-16 mm cable diameter, Screw terminal, accepts 14-18 AWG conductors, 105 °C, 600 VAC/VDC, 8 A, Mates with all B-size 6-pin cordsets and receptacles	<p>Female</p> <p>Male</p>
	B 7171-0/21	BS 7171-0/21	Glass filled nylon, PG 21 cable gland, accepts 9-16 mm cable diameter, Screw terminal, accepts 14-18 AWG conductors, 105 °C, 600 VAC/VDC, 8 A, Mates with all 7-pin cordsets and receptacles	<p>Female</p> <p>Male</p>
<p>BS 71..</p>	B 7181-0/21	BS 7181-0/21	Glass filled nylon, PG 21 cable gland, accepts 9-16 mm cable diameter, Screw terminal, accepts 14-18 AWG conductors, 105 °C, 600 VAC/VDC, 8 A, Mates with all 8-pin cordsets and receptacles	<p>Female</p> <p>Male</p>

Receptacles

• IEC IP67 Protection



Housing Style	Female Part Number	Male Part Number	Features	Pinout
<p>B 71..</p>	B 7191-0/21	BS 7191-0/21	Glass filled nylon, PG 21 cable gland, accepts 13 to 18 mm cable diameter, Screw terminal, accepts 14 to 18 AWG conductors, 105 °C, 600 VAC/VDC, 7 Amps, Mates with all 9-pin cordsets and receptacles	<p>Female</p> <p>Male</p>
	B 71101-0/21	BS 71101-0/21	Glass filled nylon, PG 21 cable gland, accepts 13 to 18 mm cable diameter, Screw terminal, accepts 14 to 18 AWG conductors, 105 °C, 600 VAC/VDC, 7 Amps, Mates with all 10-pin cordsets and receptacles	<p>Female</p> <p>Male</p>
<p>BS 71..</p>	B 71121-0/21	BS 71121-0/21	Glass filled nylon, PG 21 cable gland, accepts 13 to 18 mm cable diameter, Screw terminal, accepts 14 to 18 AWG conductors, 105 °C, 600 VAC/VDC, 7 Amps, Mates with all 12-pin cordsets and receptacles	<p>Female</p> <p>Male</p>

We reserve the right to make technical alterations without prior notice.

Conduit Adapters, 1 Port

- Attaches to standard Crouse-Hinds 3/4" Form 8, Mark 9 Conduit Bodies for transition to 3-5 Wire Minifast Connectors
- Gasket and 8-32 x 1/2 Mounting Screws
- IP67 Protection (only when all receptacles are mated or covered with plugs)
- Terminal Strips accept up to 12 AWG Wires



We reserve the right to make technical alterations without prior notice.

Housing Style	Part Number	Features	Pinout	Wiring Diagram
	CA-1/RKF 30	Nylon housing 80 °C, 250 V, 9 A, attaches to standard conduit body for transition to 3-wire Minifast connector	<p>Female</p> <p>Male</p>	
	CA-1/RKF 40	Nylon housing 80 °C, 250 V, 9 A, attaches to standard conduit body for transition to 4-wire Minifast connector	<p>Female</p> <p>Male</p>	
	CA-1/RKF 50	Nylon housing 80 °C, 250 V, 9 A, attaches to standard conduit body for transition to 5-wire Minifast connector	<p>Female</p> <p>Male</p>	

** Standard receptacle housing material is nickel plated brass..“RKF”; “RKFV” indicates stainless steel. Example: CA-2/RKFV 50.

Field Wireables

- Attaches to standard Crouse-Hinds 3/4" Form 8, Mark 9 Conduit Bodies for transition to 3-5 Wire Minifast Connectors
- Gasket and 8-32 x 1/2 Mounting Screws
- IP67 Protection (only when all receptacles are mated or covered with plugs)
- Terminal Strips accept up to 12 AWG Wires



Housing Style	Part Number	Features	Pinout	Wiring Diagram
	CA-2/RKF 30	Nylon housing, 80 °C, 250 V, 9 A, attaches to standard conduit body for transition to 3-wire Minifast connector	Female 	
	CA-2/RKF 30/S651	Nylon housing, 80 °C, 250 V, 9 A, attaches to standard conduit body for transition to 3-wire Minifast connector, parallel wired	Male 	
	CA-2/RKF 40	Nylon housing, 80 °C, 250 V, 9 A, attaches to standard conduit body for transition to 4-wire Minifast connector	Female 	
	CA-2/RKF 40/S651	Nylon housing, 80 °C, 250 V, 9 A, attaches to standard conduit body for transition to 4-wire Minifast connector, parallel wired	Male 	
	CA-2/RKF 50	Nylon housing, 80 °C, 250 V, 9 A, attaches to standard conduit body for transition to 5-wire Minifast connector	Female 	
	CA-2/RKF 50/S651	Nylon housing, 80 °C, 250 V, 9 A, attaches to standard conduit body for transition to 5-wire Minifast connector, parallel wired	Male 	

We reserve the right to make technical alterations without prior notice.

** Standard receptacle housing material is nickel plated brass.. "RKF"; "RKFV" indicates stainless steel. Example: CA-2/RKFV 50.

Tees

- Available with Parallel or Junction-style wiring
- Simplifies Wiring Installations
- Tough Molded TPU Body



We reserve the right to make technical alterations without prior notice.

Connector Style	Part Number	Features	Pinout
	RSM-2RKM 20	1 male and 2 female connectors, 250 V, 9 A, 80 °C, parallel wired, 2 conductor	
	RSM-2RKM 30	1 male and 2 female connectors, 250 V, 9 A, 80 °C, parallel wired, 3 conductor	
	RSM-2RKM 40	1 male and 2 female connectors, 250 V, 9 A, 80 °C, parallel wired, 4 conductor	
	RSM-2RKM 50	1 male and 2 female connectors, 250 V, 9 A, 80 °C, parallel wired, 5 conductor	
	RSM 50-2RKM 30	1 male 5-pin connector, 2 female 3-pin connectors, 250 V, 9.0 A, 80 °C, combine two cables into one	

Tees

Pinouts

Female				Male			
2-Pin	3-Pin	4-Pin	5-Pin	2-Pin	3-Pin	4-Pin	5-Pin

Tees

- Drop Keyway Facing Male or Female Connector
- Available with Parallel Wiring
- Simplifies Wiring Installations
- Tough Molded TPU Body



Connector Style	Part Number	Features	Pinout
<p>RSM-2RKM ..-KM</p>	RSM-2RKM 30-KM	1 male and 2 female connectors, 250 V, 9 A, 80 °C Parallel wired, 3 conductor, keyway facing male connector	
<p>RSM-2RKM 40 KM</p>	RSM-2RKM 40 KM	1 male and 2 female connectors, 250 V, 9 A, 80 °C Parallel wired, 4 conductor, keyway facing male connector	
<p>RSM-2RKM ..-KF</p>	RSM-2RKM 30-KF	1 male and 2 female connectors, 250 V, 9 A, 80 °C Parallel wired, 3 conductor, keyway facing female connector	
<p>RSM-2RKM 40-KF</p>	RSM-2RKM 40-KF	1 male and 2 female connectors, 250 V, 9 A, 80 °C Parallel wired, 4 conductor, keyway facing female connector	

We reserve the right to make technical alterations without prior notice.

Pinouts

Female		Male	
3-Pin	4-Pin	3-Pin	4-Pin

Junction Tees, Cable on Female Branches

- Junction-style Wiring
- Simplifies Wiring Installations
- Tough Molded TPU Body

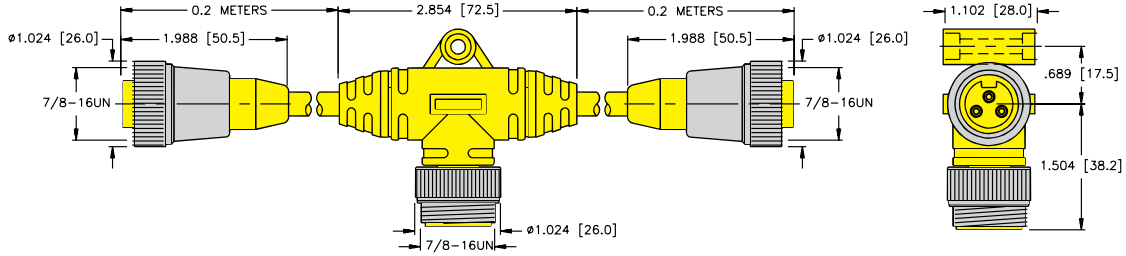

We reserve the right to make technical alterations without prior notice.

Connector Style	Part Number	Features	Pinout
See above	RKM 30-*-RSM 50-RKM 30-*	Two 3-pin female cordsets, PVC Yellow, 3x18 AWG, 7.3 mm OD, one 5-pin male connector, 250 V, 9 A, 80 °C, combine two cables into one	
	RKM 40-*-RSM 40-RKM 40-*	Two 4-pin female cordsets, PVC Yellow, 4x18 AWG, 7.3 mm OD, one 4-pin male connector, 250 V, 9 A, 80 °C, parallel wired	
	RKM 301-*-RSM 301-RKM 301-*	Two 3-pin female cordsets, PVC Yellow, 3x18 AWG, 7.3 mm OD, one 3-pin male connector, 250 V, 9 A, 80 °C, combine two cables into one, series wired	

* Length in meters.
Standard coupling nut material is nickel plated brass .. "RSM or RKM"; "RS or RK" indicates nylon and "RSV or RKV" indicates stainless steel.

Pinouts

Female			Male		
3-Pin	4-Pin	5-Pin	3-Pin	4-Pin	5-Pin

Junction Tees, Cable on Male Trunk

- Junction-style Wiring
- Simplifies Wiring Installations
- Tough Molded TPU Body

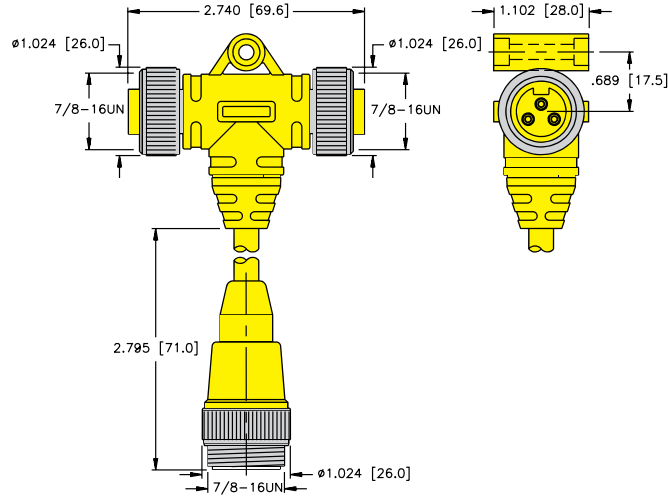

Connector Style	Part Number	Features	Pinout
See above	RKM 30-* <i>-RSM 50-RKM 30-*</i>	Two 3-pin female cordsets, PVC Yellow, 3x18 AWG, 7.3 mm O.D., one 5-pin male connector, 250 V, 9 A, 80 °C, combine two cables into one	
	RKM 40-* <i>-RSM 40-RKM 40-*</i>	Two 4-pin female cordsets, PVC Yellow, 4x18 AWG, 7.3 mm OD, one 4-pin male connector, 250 V, 9 A, 80 °C, parallel wired	
	RKM 301-* <i>-RSM 301-RKM 301-*</i>	Two 3-pin female cordsets, PVC Yellow, 3x18 AWG, 7.3 mm OD, one 3-pin male connector, 250 V, 9 A, 80 °C, combine two cables into one, series wired	

We reserve the right to make technical alterations without prior notice.

* Length in meters.
Standard coupling nut material is nickel plated brass .. "RSM or RKM"; "RS or RK" indicates nylon and "RSV or RKV" indicates stainless steel.

Pinouts

Female		Male	
3-Pin	4-Pin	3-Pin	4-Pin

h-Style Tees

- Parallel Wiring
- Simplifies Wiring Installations
- Tough Molded TPU Black Body
- NEMA 1, 3, 4, 6P
- IEC IP67 Protection



We reserve the right to make technical alterations without prior notice.

Tees

Connector Style	Part Number	Features	Wiring Diagram
	XSH-RSM-2RKM 20	1 male and 2 female connectors, 600 V, 9 A, 105 °C, parallel wired, 2 conductor	
	XSH-RSM-2RKM 30	1 male and 2 female connectors, 600 V, 9 A, 105 °C, parallel wired, 3 conductor	
	XSH-RSM-2RKM 40	1 male and 2 female connectors, 600 V, 9 A, 105 °C, parallel wired, 4 conductor	
	XSH-RSM-2RKM 50	1 male and 2 female connectors, 600 V, 9 A, 105 °C, parallel wired, 5 conductor	
	XSH-RSM-2RKM 60	1 male and 2 female connectors, 600 V, 9 A, 105 °C, parallel wired, 6 conductor	

Pinouts

Female					Male				
2-Pin	3-Pin	4-Pin	5-Pin	6-Pin	2-Pin	3-Pin	4-Pin	5-Pin	6-Pin

Quick Disconnect Adapters

- Adapt to Standard Minifast
- Cordsets
- Available w/NPSM or PG 9 Threads



Housing Style	Part Number	Features	Pinout
<p>B11... or B21..</p>	B2131-*M	Nylon, 300 V, 4 A, 3x22 AWG, 70 °C, mates with 3-pin cordsets, 1/2-14 NPSM Threads	1. Gn 2. Bn 3. Bu
	B1131-*M	Nickel plated brass, 300 V, 4 A, 3x22 AWG, 70 °C, mates with 3-pin cordsets, 1/2-14 NPSM Threads	1. Bk 2. Bn 3. Bu
	B2131-*M/S523	Nylon, 300 V, 4 A, 3x22 AWG, 70 °C, mates with 3-pin cordsets, 1/2-14 NPSM Threads	1. Bn 2. Wh 3. Bu 4. Bk
	B2141-*M	Nylon, 300 V, 4 A, 4x22 AWG, 70 °C, mates with 4-pin cordsets, 1/2-14 NPSM Threads	1. Bn 2. Wh 3. Bu 4. Bk
	B1141-*M	Nickel plated brass, 300 V, 4 A, 4x22 AWG, 70 °C, mates with 4-pin cordsets, 1/2-14 NPSM Threads	1. Bn 2. Wh 3. Bu 4. Bk
<p>B11..PG9-*M</p>	B1131-PG9-*M	Nickel plated brass, 300 V, 4 A, 3x22 AWG, 70 °C, mates with 3-pin cordsets, PG 9 Threads	1. Gn 2. Bn 3. Bu
	B1141-PG9-*M	Nickel plated brass, 300 V, 4 A, 4x22 AWG, 70 °C, mates with 4-pin cordsets, PG 9 Threads	1. Bn 2. Wh 3. Bu 4. Bk
	B1151-PG9-*M	Nickel plated brass, 300 V, 4 A, 5x22 AWG, 70 °C, mates with 5-pin cordsets, PG 9 Threads	1. Bn 2. Wh 3. Bu 4. Bk 5. Gn

We reserve the right to make technical alterations without prior notice.

Quick Disconnect Adapters

- Convert Minifast to Eurofast® or Microfast®
- Rugged Metal Connector



Housing Style	Part Number	Features	Wiring Diagram
	RSM 40-FK 4.4	Nickel plated brass, 250 V, 4 A, 80 °C, female Eurofast, male Minifast, 4-pin	
	RSM 50-FK 4.5	Nickel plated brass, 250 V, 4 A, 80 °C, female Eurofast, male Minifast, 5-pin	
	RKM 30/SB3	Nickel plated brass, 250 V, 4 A, 80 °C, female Minifast, male Microfast, 3-pin	

We reserve the right to make technical alterations without prior notice.

Accessories

Pinouts

Female			Male		
3-Pin	4-Pin	5-Pin	3-Pin	4-Pin	5-Pin

Closure Caps, A-Size

- 7/8-16 UN Threads
- Nickel Plated Brass and Stainless Steel
- Male and Female Caps



Closure Cap Style	Part Number	Features
	RKM-CC	Nickel plated brass, 7/8-16 UN threads, 6" stainless steel lanyard, closure cap, mates to male cordsets, receptacles
	RKMV-CC	Stainless steel, 7/8-16 UN threads, 6" stainless steel lanyard, closure cap, mates to male cordsets, receptacles
	RSM-CC	Nickel plated brass, 7/8-16 UN threads, 6" stainless steel lanyard, closure cap, mates to female cordsets, receptacles
	RSMV-CC	Stainless steel, 7/8-16 UN threads, 6" stainless steel lanyard, closure cap, mates to female cordsets, receptacles
	RKF-CC	Nickel plated brass, 7/8-16 UN threads, 6" stainless steel lanyard, Closure cap, mates to male cordsets, receptacles
	RKFV-CC	Stainless steel, 7/8-16 UN threads, 6" stainless steel lanyard, closure cap, mates to male cordsets, receptacles
	RSF-CC	Nickel plated brass, 7/8-16 UN threads, 6" stainless steel lanyard, closure cap, mates to female cordsets, receptacles
	RSFV-CC	Stainless steel, 7/8-16 UN threads, 6" stainless steel lanyard, closure cap, mates to female cordsets, receptacles
	RKF-MC	Nickel plated brass, 7/8-16 UN threads, BUNA-N gasket, closure cap, mates to male cordsets, receptacles
	RKFV-MC	Stainless steel, 7/8-16 UN threads, BUNA-N gasket, closure cap, mates to male cordsets, receptacles
	RSF-MC	Nickel plated brass, 7/8-16 UN threads, BUNA-N gasket and O-ring, closure cap, mates to female cordsets, receptacles
	RSFV-MC	Stainless steel, 7/8-16 UN threads, BUNA-N gasket and O-ring, closure cap, mates to female cordsets, receptacles

We reserve the right to make technical alterations without prior notice.

Note: Add "/S1599" to the end of Part Number for closure caps assembled on cordsets.



Closure Caps, B-Size

- 1-16 UN Threads
- Nickel Plated Brass and Stainless Steel
- Male and Female Caps



Closure Cap Style	Part Number	Features
	RKMB-CC	Nickel plated brass, 1-16 UN threads, 6" stainless steel lanyard, closure cap, mates to male cordsets
	RKMBV-CC	Stainless steel, 1-16 UN threads 6" stainless steel lanyard, closure cap, mates to male cordsets
	RSMB-CC	Nickel plated brass, 1-16 UN threads, 6" stainless steel lanyard, closure cap, mates to female cordsets
	RSMBV-CC	Stainless steel, 1-16 UN threads, 6" stainless steel lanyard, closure cap, mates to female cordsets
	RKFB-CC	Nickel plated brass, 1-16 UN threads, 6" stainless steel lanyard, Closure cap, mates to male receptacles
	RKFBV-CC	Stainless steel, 1-16 UN threads, 6" stainless steel lanyard, Closure cap, mates to male receptacles
	RSFB-CC	Nickel plated brass, 1-16 UN threads, 6" stainless steel lanyard, closure cap, mates to female receptacles
	RSFBV-CC	Stainless steel, 1-16 UN threads, 6" stainless steel lanyard, closure cap, mates to female receptacles
	RKFB-MC	Nickel plated brass, 1-16 UN threads, BUNA-N gasket and O-ring, closure cap, mates to male receptacles
	RKFBV-MC	Stainless steel, 1-16 UN threads, BUNA-N gasket and O-ring, closure cap, mates to male receptacles
	RSFB-MC	Nickel plated brass, 1-16 UN threads, BUNA-N gasket and O-ring, closure cap, mates to female receptacles
	RSFBV-MC	Stainless steel, 1-16 UN threads, BUNA-N gasket and O-ring, closure cap, mates to female receptacles

We reserve the right to make technical alterations without prior notice.

Note: Add "/S1599" to the end of Part Number for closure caps assembled on cordsets.



Accessories

Closure Caps, C-Size

- 1 1/8-16 UN Threads
- Nickel Plated Brass and Stainless Steel
- Male and Female Caps



Closure Cap Style	Part Number	Features
	RKMC-CC	Nickel plated brass, 11/8-16 UN threads, 6" stainless steel lanyard, closure cap, mates to male cordsets
	RKMCV-CC	Stainless steel, 11/8-16 UN threads, 6" stainless steel lanyard, closure cap, mates to male cordsets
	RSMC-CC	Nickel plated brass, 11/8-16 UN threads, 6" stainless steel lanyard, closure cap, mates to female cordsets
	RSMCV-CC	Stainless steel, 11/8-16 UN threads, 6" stainless steel lanyard, closure cap, mates to female cordsets
	RKFC-CC	Nickel plated brass, 11/8-16 UN threads, 6" stainless steel lanyard, closure cap, mates to male receptacles
	RKFCV-CC	Stainless steel, 11/8-16 UN threads, 6" stainless steel lanyard, closure cap, mates to male receptacles
	RSFC-CC	Nickel plated brass, 11/8-16 UN threads, 6" stainless steel lanyard, closure cap, mates to female receptacles
	RSFCV-CC	Stainless steel, 11/8-16 UN threads, 6" stainless steel lanyard, closure cap, mates to female receptacles
	RKFC-MC	Nickel plated brass, 11/8-16 UN threads, BUNA-N gasket and O-ring, closure cap, mates to male receptacles
	RKFCV-MC	Stainless steel, 11/8-16 UN threads, BUNA-N gasket and O-ring, closure cap, mates to male receptacles
	RSFC-MC	Nickel plated brass, 11/8-16 UN threads, BUNA-N gasket and O-ring, closure cap, mates to female receptacles
	RSFCV-MC	Stainless steel, 11/8-16 UN threads, BUNA-N gasket and O-ring, closure cap, mates to female receptacles

We reserve the right to make technical alterations without prior notice.

Note: Add "/S1599" to the end of Part Number for closure caps assembled on cordsets.



Housing Style	Part Number	Features
	DUST CAP RKM (50/PACKAGE)	Nylon, closure cap, mates to junction boxes and female cordsets
	DUST CAP RSM (50/PACKAGE)	Nylon, closure cap, mates to junction boxes and male cordsets
	FF 78 AL	Anodized Aluminum, female adapter to be used with 2 female coupling nuts
	MB-MINITEE 1	Nylon, mounting bracket for Minifast tees

We reserve the right to make technical alterations without prior notice.

Part Number Keys	G2
Cordsets	G4
Receptacles	G9
Field Wireables	G27
Closure Caps	G30

Features

- M16 threaded connectors
- 5 through 8, 12, 14 and 19-pin
- Up to 8 Amp, 300 Volt rated
- Multiple tee configurations
- IEC IP67 protection
- Signal consolidation



Cordset Part Number Key

Part Number Keys are to assist in IDENTIFICATION ONLY. Consult factory for catalog items not identified.

B	S	M	12	999	*	/S..
M16 Versafast Cordset				Varieties		
Gender				(blank) = PVC jacket		
K = female connector				/S90 = TPU jacket		
S = male connector				/S101 = Flexlife®-20, high flex cable		
Configuration				Length in Meters		
(blank) = assembled connector				Number of Wires / AWG / Color Codes		
M = straight molded				<u>5-Pin</u>		
WM = right angle molded				084 = 5x18 AWG BN, BU, WH, BU, BK, GY		
Housing Material				<u>6-Pin</u>		
(blank) = nickel plated brass				085 = 6x18 AWG BN, BU, WH, BU, BK, GY, PK		
K = nylon				<u>7-Pin</u>		
V = stainless steel				086 = 7x18 AWG WH, BN, GN, YE, GY, PK, BU		
Insertion Point of Extension Cable and Second Prefix*				<u>8-Pin</u>		
* Male connector listed first, female connector second				087 = 8x18 AWG WH, BN, GN, YE, GY, PK, BU, RD		
Example: BSM BKM 12-001-1				<u>12-Pin</u>		
Number of Pins				001 = 12x22 AWG BN, BU, WH, GN, YE, GY, PK, RD, BK, OG, TN, VT / TPU jacket		
5 = 5				967 = 12x22 AWG (same color code as 001) / PVC jacket		
6 = 6				999 = 12x22 AWG (same color code as 001) / TPE jacket		
7 = 7				<u>14-Pin</u>		
8 = 8				000 = 14x22 AWG BN, RD/BU, BK, PK, GN, BU, OG, GY/BN, VT, WH, RD, GY, YE, TN / TPE jacket		
				002 = 14x22 AWG (same color code as 000) / TPU jacket		
				755 = 12x24 AWG OG, BK, GN, GY, BN, TN, VT, RD, WH, YE, PK, BU / PVC jacket		
				836 = 10x24 AWG GY, GN, BK, BN, PK, YE, WH, RD, VT, BU / PVC jacket		
				917 = 12x24 AWG RD/BU, GY, GN, BK, GY/PK, BN, PK, YE, WH, RD, VT, BU / PVC jacket		
				954 = 10x24 AWG (same color code as 836) / TPE jacket		
				998 = 14x22 AWG (same color code as 000) / PVC jacket		
				<u>19-Pin</u>		
				995 = 19x22 AWG BU, GY/PK, RD/BU, WH/GN, BK, BN/GN, PK, WH/YE, GN, YE/BN, BU, OG, GY/BN, VT, WH, RD, GY, YE, TN / PVC jacket		
				996 = 19x22 AWG (same color code as 995) / TPU jacket		
				997 = 19x22 AWG (same color code as 995) / TPE jacket		

Extension Examples

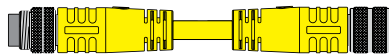

B S M **B K W** **12** - **999** - ***** /S..

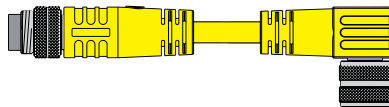

B S M **B K W M** **12** - **999** - ***** /S..

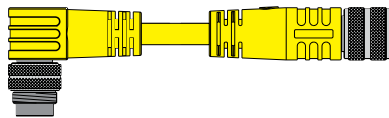

B S W M **B K M** **12** - **999** - ***** /S..

Receptacle Part Number Key

Part Number Keys are to assist in IDENTIFICATION ONLY. Consult factory for catalog items not identified.

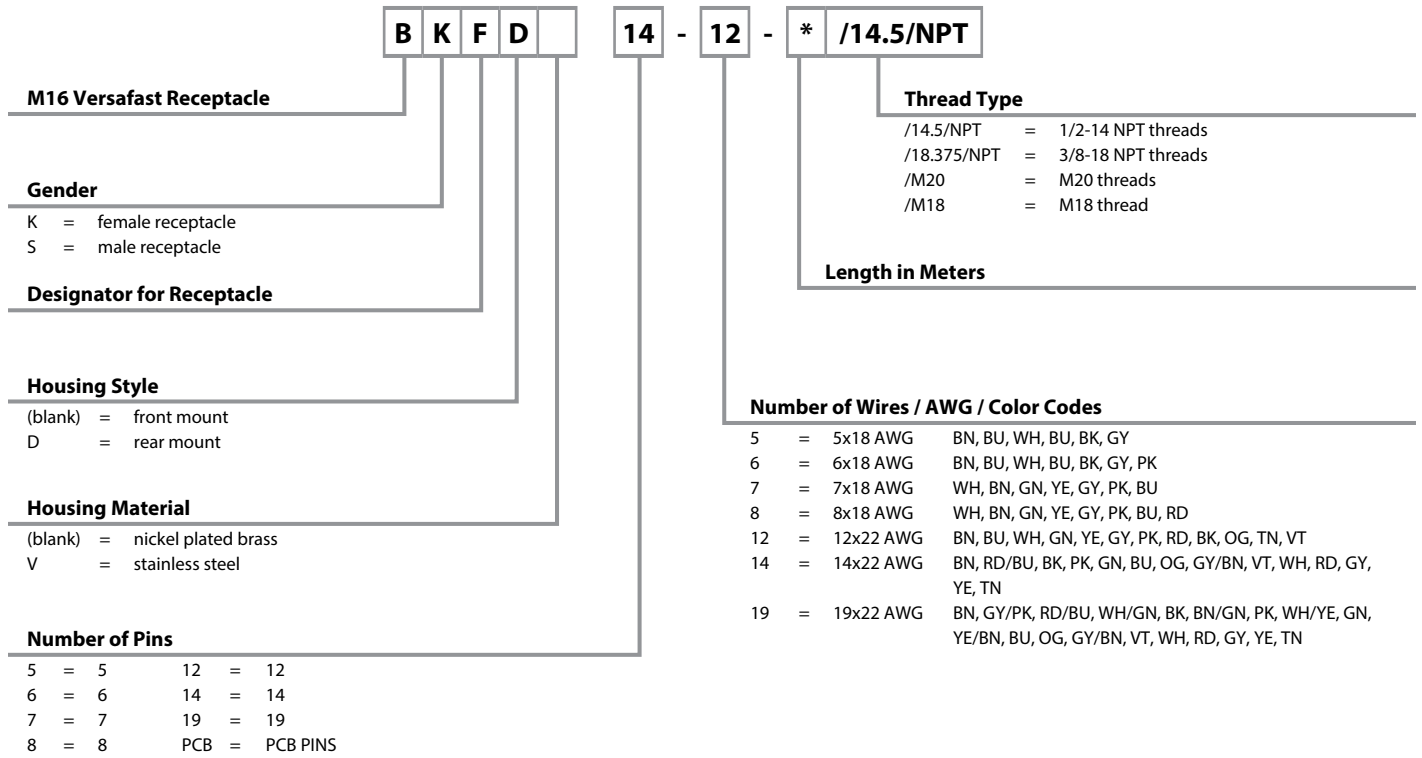

versafast®

5 - 8 Pin Cordsets

• IEC IP67 Protection



Connector Style	Female Part Number	Male Part Number	Features	Pinout
<p>BKM ..</p>	<p>BKM 5-084-* BKWM 5-084-*</p>	<p>BSM 5-084-* BSWM 5-084-*</p>	<p>ITC/PLTC PVC Yellow, 5x18 AWG, 105 °C, 300 VAC/VDC, 8 A, 7.6 mm OD, Cable #RF51084-*,M, 5-wire DC application, Flexlife®</p>	<p>Female</p> <p>Male</p>
<p>BKWM ..</p>	<p>BKM 6-085-* BKWM 6-085-*</p>	<p>BSM 6-085-* BSWM 6-085-*</p>	<p>ITC/PLTC PVC Yellow, 6x18 AWG, 105 °C, 300 VAC/VDC, 7 A, 8.4 mm OD, Cable #RF51085-*,M, 6-wire DC application, Flexlife</p>	<p>Female</p> <p>Male</p>
<p>BSM ..</p>	<p>BKM 7-086-* BKWM 7-086-*</p>	<p>BSM 7-086-* BSWM 7-086-*</p>	<p>ITC/ PLTC PVC Yellow, 7x18 AWG, 105 °C, 125 VAC/VDC, 7 A, 8.1 mm OD, Cable #RF51086-*,M, 7-wire DC application, Flexlife</p>	<p>Female</p> <p>Male</p>
<p>BSWM ..</p>	<p>BKM 8-087-* BKWM 8-087-*</p>	<p>BSM 8-087-* BSWM 8-087-*</p>	<p>ITC/PLTC PVC Yellow, 8x18 AWG, 105 °C, 125 VAC/VDC, 7 A, 8.9 mm OD, Cable #RF51087-*,M, 8-wire DC application, Flexlife</p>	<p>Female</p> <p>Male</p>

We reserve the right to make technical alterations without prior notice.

* Length in meters. Standard cable lengths are 5 and 10 meters. Consult factory for other lengths.
Standard housing and coupling nut material is anodized aluminum.. "BKM.."; "BKWM.." indicates stainless steel and "BKMK.." indicates nylon.



12-Pin Cordsets

- For Eurofast® Junction Boxes and multi-conductor applications
- IEC IP67 Protection



Connector Style	Female Part Number	Male Part Number	Features	Pinout
<p>BKM ..</p>	BKM 12-001-* BKWM 12-001-*	BSM 12-001-* BSWM 12-001-*	AWM TPU Black, 12x22 AWG, 90 °C, 125 VAC/VDC, 4 A, 7.6 mm OD, Cable #RF51001-*M, 12-wire DC applications, Flexlife®	<p>Female</p> <p>Male</p>
<p>BKWM ..</p>	BKM 12-967-* BKWM 12-967-*	BSM 12-967-* BSWM 12-967-*	ITC/PLTC PVC Black, 12x22 AWG, 105 °C, 125 VAC/VDC, 4 A, 7.5 mm OD, Cable #RF50967-*M, 12-wire DC applications, Flexlife	
<p>BSM ..</p>				
<p>BSWM ..</p>	BKM 12-999-*/S101 BKWM 12-999-*/S101	BSM 12-999-*/S101 BSWM 12-999-*/S101	AWM TPE Black, 12x22 AWG, 105 °C, 125 VAC/VDC, 4 A, 8.0 mm OD, Cable #RF50999-*M, 12-wire DC applications, Flexlife-20, high flex - Over 20 million cycles	

We reserve the right to make technical alterations without prior notice.

Cordsets

* Length in meters. Standard cable lengths are 5 and 10 meters. Consult factory for other lengths. Standard housing and coupling nut material is anodized aluminum.. "BKM.."; "BKWM.." indicates stainless steel and "BKMK.." indicates nylon.

14-Pin Cordsets

- For Picofast® Junction Boxes and multi-conductor applications
- IEC IP67 Protection



Connector Style	Female Part Number	Male Part Number	Features	Pinout
<p>BKM ..</p>	<p>BKM 14-002-* BKWM 14-002-*</p>	<p>BSM 14-002-* BSWM 14-002-*</p>	<p>AWM TPU Black, 14x22 AWG, 90 °C, 30 VAC/VDC, 3 A, 7.6 mm OD, Cable #RF51002-*M, 14-wire DC applications, Flexlife®</p>	<p>Female</p>
<p>BKWM ..</p>	<p>BKM 14-000-*/S101 BKWM 14-000-*/S101</p>	<p>BSM 14-000-*/S101 BSWM 14-000-*/S101</p>	<p>AWM TPE Black, 15x22 AWG, 105 °C, 30 VAC/VDC, 3 A, 9.0 mm OD, Cable #RF51000-*M, 14-wire DC applications, Flexlife-20, high flex - over 20 million cycles</p>	
<p>BKM ..</p>	<p>BKM 14-998-* BKWM 14-998-*</p>	<p>BSM 14-998-* BSWM 14-998-*</p>	<p>ITC/PLTC PVC Black, 14x22 AWG, 105 °C, 30 VAC/VDC, 3 A, 7.6 mm OD, Cable #RF50998-*M, 14-wire DC applications, Flexlife</p>	
<p>BSWM ..</p>	<p>BKM 14-755-* BKWM 14-755-*</p>	<p>BSM 14-755-* BSWM 14-755-*</p>	<p>AWM PVC Black, 12x24 AWG, 105 °C, 30 VAC/VDC, 3 A, 6.7 mm OD, Cable #RF50755-*M, 12-wire DC applications, Flexlife</p>	
				<p>Male</p>

We reserve the right to make technical alterations without prior notice.

* Length in meters. Standard cable lengths are 5 and 10 meters. Consult factory for other lengths. Standard housing and coupling nut material is anodized aluminum.. "BKM.."; "BKMV.." indicates stainless steel and "BKMK.." indicates nylon.



14-Pin Cordsets

- For Eurofast®/Picofast® Junction Boxes and multi-conductor applications
- IEC IP67 Protection



Connector Style	Female Part Number	Male Part Number	Features	Pinout
<p>BKM ..</p>	<p>BKM 14-836-* BKWM 14-836-*</p>	<p>BSM 14-836-* BSWM 14-836-*</p>	<p>AWM PVC Black, 10x24 AWG, 105 °C, 30 VAC/VDC, 3 A, 6.6 mm OD, Cable #RF50836-*M, 10-wire DC applications, junction box, VB 803M(Z)-BS14, Flexlife®</p>	<p>Female</p>
<p>BKWM ..</p>	<p>BKM 14-954-*/S101 BKWM 14-954-*/S101</p>	<p>BSM 14-954-*/S101 BSWM 14-954-*/S101</p>	<p>AWM TPE Black, 12x24 AWG, 105 °C, 30 VAC/VDC, 3 A, 7.6 mm OD, Cable #RF-50943*M, 10-wire DC applications, junction box VB 803M(Z)-BS14, Flexlife-20, high flex - over 20 million cycles</p>	<p>A. N/C C. GY E. GN G. BK J. N/C L. N/C M. BN N. PK O. YE P. WH R. RD S. VT T. N/C U. BU</p>
<p>BSM ..</p>				
<p>BSWM ..</p>	<p>BKM 14-917-* BKWM 14-917-*</p>	<p>BSM 14-917-* BSWM 14-917-*</p>	<p>AWM PVC Yellow, 12x24 AWG, 105 °C, 30 VAC/VDC, 3 A, 6.6 mm OD, Cable #RF50917-*M, 12-wire DC applications, junction boxes 4MBM12-5-BS14 & VB 404M(Z)-BS14, Flexlife</p>	<p>Male</p>

We reserve the right to make technical alterations without prior notice.

* Length in meters. Standard cable lengths are 5 and 10 meters. Consult factory for other lengths. Standard housing and coupling nut material is anodized aluminum.. "BKM.."; "BKWM.." indicates stainless steel and "BKMV.." indicates nylon.

Cordsets

19-Pin Cordsets

- For Picofast® Junction Boxes and multi-conductor applications
- IEC IP67 Protection





Connector Style	Female Part Number	Male Part Number	Features	Pinout
<p>BKM ..</p>	BKM 19-873-* BKWM 19-873-*	BSM 19-873-* BSWM 19-873-*	AWM PVC Black, 19x26 AWG, 105 °C, 30 VAC/VDC, 3 A, 7.1 mm OD, Cable #RF50873-*,M, 19-wire DC applications, Flexlife®	A. RD/BU B. WH/GN C. GY D. BN/GN E. GN F. GN/YE G. BK H. WH/YE I. WH/GY K. GY/BN L. GY/PK M. BN N. PK O. YE P. WH R. RD S. VT T. YE/BN U. BU
<p>BKWM ..</p>				<p style="text-align: center;">Female</p>
<p>BSM ..</p>	BKM 19-995-* BKWM 19-995-*	BSM 19-995-* BSWM 19-995-*	ITC/PLTC PVC Black, 19x22 AWG, 105 °C, 30 VAC/VDC, 3 A, 8.5 mm OD, Cable #RF50995-*,M, 19-wire DC applications & junction box VB 804M(Z)-BS19, Flexlife	A. BU B. GY/PK C. RD/BU D. WH/GN E. BK F. BN/GN G. PK H. WH/YE I. GN K. YE/BN L. BN M. OG N. GY/BN O. VT P. WH R. RD S. GY T. YE U. TN
<p>BSWM ..</p>				<p style="text-align: center;">Male</p>

We reserve the right to make technical alterations without prior notice.

* Length in meters. Standard cable lengths are 5 and 10 meters. Consult factory for other lengths. Standard housing and coupling nut material is anodized aluminum.. "BKM.."; "BKMV.." indicates stainless steel and "BKMK.." indicates nylon.

M16 Receptacle Selection Guide

Mounting Style	Image	Panel Thread Types	Page
<p>Front Mount</p>		<p><u>M18</u> <u>G12</u></p> <p><u>M20</u> <u>G14</u></p> <p><u>1/2-14 NPT</u> <u>G16</u></p> <p><u>3/8-18 NPT</u> <u>G18</u></p>	
<p>Rear Mount</p>		<p><u>M18</u> <u>G22</u></p>	
<p>PCB Mount</p>		<p><u>PCB</u> <u>G24</u></p>	

We reserve the right to make technical alterations without prior notice.

Receptacles

5 - 8 Pin Receptacles, Front Mount

- IEC IP67 Protection



Connector Style	Female Part Number	Male Part Number	Features	Pinout
<p>BKF ..(5-8 pin)</p>	BKF 5-5-*	BSF 5-5-*	5x20 AWG, 105 °C, 300 VAC/VDC, 8 A, 5-Wire DC Application	<p>Female</p> <p>Male</p>
	BKF 6-6-*	BSF 6-6-*	6x20 AWG, 105 °C, 300 VAC/VDC, 7 A, 6-Wire DC Application	<p>Female</p> <p>Male</p>
	BKF 7-7-*	BSF 7-7-*	7x20 AWG, 105 °C, 125 VAC/VDC, 7 A, 7-Wire DC Application	<p>Female</p> <p>Male</p>
	BKF 8-8-*	BSF 8-8-*	8x20 AWG, 105 °C, 125 VAC/VDC, 7 A, 8-Wire DC Application	<p>Female</p> <p>Male</p>
<p>BSF ..(5-8 pin)</p>				

We reserve the right to make technical alterations without prior notice.

* Length in meters. Standard lead length is 0.5 meters. Consult factory for other lengths.
 Standard housing material is nickel plated brass.
 To specify PVC jacketed cable, add "/S717" to the end of the part number.



12, 14 and 19-Pin Receptacles, Front Mount

- For use with Junction Box Home Run Cables
- IEC IP67 Protection



Connector Style	Female Part Number	Male Part Number	Features	Pinout
<p>BKF ..(12, 14, 19 pin)</p> <p>Typical panel cutout is 18 x 17 mm</p>	BKF 12-12-*	BSF 12-12-*	12x24 AWG, 105 °C, 125 VAC/VDC, 4 A, mates with 12-pin connectors, 12 conductors	<p>Female</p> <p>Male</p>
	BKF 14-10-*	BSF 14-10-*	10x24 AWG, 105 °C, 30 VAC/VDC, 3 A, mates with 14-pin connectors, 10 conductors	<p>Female</p>
	BKF 14-12-*	BSF 14-12-*	12x24 AWG, 105 °C, 30 VAC/VDC, 3 A, mates with 14-pin connectors, 12 conductors	<p>Female</p> <p>Male</p>
	BKF 14-14-*	BSF 14-14-*	14x24 AWG, 105 °C, 30 VAC/VDC, 3 A, mates with 14-pin connectors, 14 conductors	<p>Female</p> <p>Male</p>
	BKF 19-19-*	BSF 19-19-*	19x24 AWG, 105 °C, 30 VAC/VDC, 3 A, mates with 19-pin connectors, 19 conductors	<p>Female</p> <p>Male</p>

We reserve the right to make technical alterations without prior notice.

Receptacles

* Length in meters. Standard lead length is 0.5 meters. Consult factory for other lengths. Standard housing material is nickel plated brass. To specify PVC jacketed cable, add "/S717" to the end of the part number.

• IEC IP67 Protection



Connector Style	Female Part Number	Male Part Number	Features	Pinout
<p>BKF .. M18 (5-8 pin)</p> <p>Typical panel cutout is 18.6 mm</p>	BKF 5-5-*/M18	BSF 5-5-*/M18	5x18 AWG, 105 °C, 300 VAC/VDC, 8 A, 5-wire DC application	<p>Female</p> <p>Male</p>
	BKF 6-6-*/M18	BSF 6-6-*/M18	6x18 AWG, 105 °C, 300 VAC/VDC, 7 A, 6-wire DC application	<p>Female</p> <p>Male</p>
	BKF 7-7-*/M18	BSF 7-7-*/M18	7x18 AWG, 105 °C, 125 VAC/VDC, 7 A, 7-wire DC application	<p>Female</p> <p>Male</p>
	BKF 8-8-*/M18	BSF 8-8-*/M18	8x18 AWG, 105 °C, 125 VAC/VDC, 7 A, 8-wire DC application	<p>Female</p> <p>Male</p>

We reserve the right to make technical alterations without prior notice.

* Length in meters. Standard lead length is 0.5 meters. Consult factory for other lengths.
Standard housing material is nickel plated brass "BSF.." and "BSFV.." indicates stainless steel.
To specify PVC jacketed cable, add "/S717" to the end of the part number.

12, 14 and 19-Pin Receptacles, Front Mount, M18 Threads

- For use with Junction Box Home Run Cables
- IEC IP67 Protection



Connector Style	Female Part Number	Male Part Number	Features	Pinout		
<p>BKF .. M18 (12, 14, 19 pin)</p> <p>Typical panel cutout is 18.6 mm</p>	BKF 12-12-*/M18	BSF 12-12-*/M18	12x22 AWG, 105 °C, 125 VAC/VDC, 4 A, mates with 12-pin connectors, 12 conductors	A. BN B. BU C. WH D. GN E. YE F. GY G. PK H. RD J. BK K. OG L. TN M. VT	<p>Female</p> <p>Male</p>	
	BKF 14-10-*/M18	BSF 14-10-*/M18	10x22 AWG, 105 °C, 30 VAC/VDC, 3 A, mates with 14-pin connectors, 10 conductors	C. GY E. GN G. BK M. BN N. PK	O. YE P. WH R. RD S. VT U. BU	<p>Female</p>
	BKF 14-12-*/M18	BSF 14-12-*/M18	12x22 AWG 105 °C 30 VAC/VDC, 3 A mates with 14-pin connectors, 12 conductors	C. OG E. BK G. GN J. GY M. BN N. TN	O. VT P. RD R. WH S. YE T. PK U. BU	<p>Male</p>
	BKF 14-14-*/M18	BSF 14-14-*/M18	14x22 AWG, 105 °C, 30 VAC/VDC, 3 A, mates with 14-pin connectors, 14 conductors	A. BN C. RD/BU E. BK G. PK J. GN L. BU M. OG	N. GY/BN O. VT P. WH R. RD S. GY T. YE U. TN	<p>Female</p>
<p>BSF .. M18 (12, 14, 19 pin)</p> <p>Typical panel cutout is 18.6 mm</p>	BKF 19-19-*/M18	BSF 19-19-*/M18	19x22 AWG, 105 °C, 30 VAC/VDC, 3 A, mates with 19-pin connectors, 19 conductors	A. BU B. GY/PK C. RD/BU D. WH/GN E. BK F. BN/GN G. PK H. WH/YE I. GN K. YE/BN	L. BN M. OG N. GY/BN O. VT P. WH R. RD S. GY T. YE U. TN	<p>Female</p> <p>Male</p>

We reserve the right to make technical alterations without prior notice.

Receptacles

* Length in meters. Standard lead length is 0.5 meters. Consult factory for other lengths. Standard housing material is nickel plated brass "BSF.." and "BSFV.." indicates stainless steel. To specify PVC jacketed cable, add "/S717" to the end of the part number.

• IEC IP67 Protection



Connector Style	Female Part Number	Male Part Number	Features	Pinout
<p>BKF ..M20 (5-8 pin)</p>	BKF 5-5-*/M20	BSF 5-5-*/M20	5x18 AWG, 105 °C, 300 VAC/VDC, 8 A, 5-Wire DC applications	<p>Female</p> <p>Male</p>
	BKF 6-6-*/M20	BSF 6-6-*/M20	6x18 AWG, 105 °C, 300 VAC/VDC, 7 A, 6-Wire DC applications	<p>Female</p> <p>Male</p>
<p>BSF ..M20 (5-8 pin)</p>	BKF 7-7-*/M20	BSF 7-7-*/M20	7x18 AWG, 105 °C, 125 VAC/VDC, 7 A, 7-Wire DC applications	<p>Female</p> <p>Male</p>
	BKF 8-8-*/M20	BSF 8-8-*/M20	8x18 AWG, 105 °C, 125 VAC/VDC, 7 A, 8-Wire DC applications	<p>Female</p> <p>Male</p>

We reserve the right to make technical alterations without prior notice.

* Length in meters. Standard lead length is 0.5 meters. Consult factory for other lengths.
Standard housing material is nickel plated brass "BSF.." and "BSFV.." indicates stainless steel.
To specify PVC jacketed cable, add "/S717" to the end of the part number.



12, 14 and 19-Pin Receptacles, Front Mount, M20 Threads

- For use with Junction Box Home Run Cables
- IEC IP67 Protection



Connector Style	Female Part Number	Male Part Number	Features	Pinout	
<p>BKF ..M20 (12, 14, 19 pin)</p> <p>Typical panel cutout is 18.6 mm</p>	BKF 12-12-*/M20	BSF 12-12-*/M20	12x22 AWG, 105 °C, 125 VAC/VDC, 4 A, mates with 12-pin connectors, 12 conductors	<p>Female</p> <p>Male</p>	
				<p>A. BN G. PK B. BU H. RD C. WH J. BK D. GN K. OG E. YE L. TN F. GY M. VT</p>	
	BKF 14-10-*/M20	BSF 14-10-*/M20	10x22 AWG, 105 °C, 30 VAC/VDC, 3 A, mates with 14-pin connectors, 10 conductors	<p>Female</p>	
				<p>C. GY O. YE E. GN P. WH G. BK R. RD M. BN S. VT N. PK U. BU</p>	
	BKF 14-12-*/M20	BSF 14-12-*/M20	12x22 AWG, 105 °C, 30 VAC/VDC, 3 A, mates with 14-pin connectors, 12 conductors	<p>Female</p>	
				<p>C. OG O. VT E. BK P. RD G. GN R. WH J. GY S. YE M. BN T. PK N. TN U. BU</p>	
<p>BSF ..M20 (12, 14, 19 pin)</p> <p>Typical panel cutout is 20.4 mm</p>	BKF 14-14-*/M20	BSF 14-14-*/M20	14x22 AWG, 105 °C, 30 VAC/VDC, 3 A, mates with 14-pin connectors, 14 conductors	<p>Female</p>	
				<p>A. BN N. GY/BN C. RD/BU O. VT E. BK P. WH G. PK R. RD J. GN S. GY L. BU T. YE M. OG U. TN</p>	
	BKF 19-19-*/M20	BSF 19-19-*/M20	19x22 AWG, 105 °C, 30 VAC/VDC, 3 A, mates with 19-pin connectors, 19 conductors	<p>Female</p>	
				<p>A. BU L. BN B. GY/PK M. OG C. RD/BU N. GY/BN D. WH/GN O. VT E. BK P. WH F. BN/GN R. RD G. PK S. GY H. WH/YE T. YE I. GN U. TN K. YE/BN</p>	
				<p>Male</p>	

We reserve the right to make technical alterations without prior notice.

Receptacles

* Length in meters. Standard lead length is 0.5 meters. Consult factory for other lengths. Standard housing material is nickel plated brass "BSF.." and "BSFV.." indicates stainless steel. To specify PVC jacketed cable, add "/S717" to the end of the part number.

5 - 8 Pin Receptacles, Front Mount, 1/2-14 NPT Threads

- IEC IP67 Protection



Connector Style	Female Part Number	Male Part Number	Features	Pinout
<p>BKF ..1/2-14 NPT (5-8 pin)</p> <p>Typical panel cutout is 17.5 mm</p>	BKF 5-5-*/14.5/NPT	BSF 5-5-*/14.5/NPT	5x18 AWG, 105 °C, 300 VAC/VDC, 8 A, 5-Wire DC applications	<p>Female</p> <p>Male</p>
	BKF 6-6-*/14.5/NPT	BSF 6-6-*/14.5/NPT	6x18 AWG, 105 °C, 300 VAC/VDC, 7 A, 6-Wire DC applications	<p>Female</p> <p>Male</p>
	BKF 7-7-*/14.5/NPT	BSF 7-7-*/14.5/NPT	7x18 AWG, 105 °C, 125 VAC/VDC, 7 A, 7-Wire DC applications	<p>Female</p> <p>Male</p>
<p>BSF ..1/2-14 NPT (5-8 pin)</p> <p>Typical panel cutout is 22.5 mm</p>	BKF 8-8-*/14.5/NPT	BSF 8-8-*/14.5/NPT	8x18 AWG, 105 °C, 125 VAC/VDC, 7 A, 8-Wire DC applications	<p>Female</p> <p>Male</p>

We reserve the right to make technical alterations without prior notice.

* Length in meters. Standard lead length is 0.5 meters. Consult factory for other lengths.
 Standard housing material is nickel plated brass "BSF.." and "BSFV.." indicates stainless steel.
 To specify PVC jacketed cable, add "/S717" to the end of the part number.



12, 14 and 19-Pin Receptacles, Front Mount, 1/2-14 NPT Threads

- For use with Junction Box Home Run Cables
- IEC IP67 Protection



Connector Style	Female Part Number	Male Part Number	Features	Pinout		
<p>BKF ..1/2-14 NPT (12, 14, 19 pin)</p>	BKF 12-12-*/14.5/NPT	BSF 12-12-*/14.5/NPT	12x22 AWG, 105 °C, 125 VAC/VDC, 4 A, mates with 12-pin connectors, 12 conductors	A. BN	G. PK	<p>Female</p>
				B. BU	H. RD	<p>Male</p>
	BKF 14-10-*/14.5/NPT	BSF 14-10-*/14.5/NPT	10x22 AWG, 105 °C, 30 VAC/VDC, 3 A, mates with 14-pin connectors, 10 conductors	C. GY	O. YE	<p>Female</p>
				E. GN	P. WH	<p>Male</p>
	BKF 14-12-*/14.5/NPT	BSF 14-12-*/14.5/NPT	12x22 AWG, 105 °C, 30 VAC/VDC, 3 A, mates with 14-pin connectors, 12 conductors	C. OG	O. VT	<p>Female</p>
				E. BK	P. RD	<p>Male</p>
	BKF 14-14-*/14.5/NPT	BSF 14-14-*/14.5/NPT	14x22 AWG, 105 °C, 30 VAC/VDC, 3 A, mates with 14-pin connectors, 14 conductors	A. BN	N. GY/BN	<p>Female</p>
				C. RD/BU	O. VT	<p>Male</p>
<p>BSF ..1/2-14 NPT (12, 14, 19 pin)</p>	BKF 19-19-*/14.5/NPT	BSF 19-19-*/14.5/NPT	19x22 AWG, 105 °C, 30 VAC/VDC, 3 A, mates with 19-pin connectors, 19 conductors	A. BU	L. BN	<p>Female</p>
				B. GY/PK	M. OG	<p>Male</p>

We reserve the right to make technical alterations without prior notice.

Receptacles

* Length in meters. Standard lead length is 0.5 meters. Consult factory for other lengths. Standard housing material is nickel plated brass "BSF.." and "BSFV.." indicates stainless steel. To specify PVC jacketed cable, add "/S717" to the end of the part number.

5 - 8 Pin Receptacles, Front Mount, 3/8-18 NPT Threads

• IEC IP67 Protection



Connector Style	Female Part Number	Male Part Number	Features	Pinout
<p>BKF ..3/8-18 NPT (5-8 pin)</p> <p>Typical panel cutout is 17.5 mm</p>	BKF 5-5-*/18.375/NPT	BSF 5-5-*/18.375/NPT	5x18 AWG, 105 °C, 300 VAC/VDC, 8 A, 5-Wire DC applications	<p>Female</p> <p>Male</p>
<p>BKF 6-6-*/18.375/NPT</p> <p>Typical panel cutout is 17.5 mm</p>	BKF 6-6-*/18.375/NPT	BSF 6-6-*/18.375/NPT	6x18 AWG, 105 °C, 300 VAC/VDC, 7 A, 6-Wire DC applications	<p>Female</p> <p>Male</p>
<p>BSF ..3/8-18 NPT (5-8 pin)</p> <p>Typical panel cutout is 17.5 mm</p>	BKF 7-7-*/18.375/NPT	BSF 7-7-*/18.375/NPT	7x18 AWG, 105 °C, 125 VAC/VDC, 7 A, 7-Wire DC applications	<p>Female</p> <p>Male</p>
<p>BSF ..3/8-18 NPT (5-8 pin)</p> <p>Typical panel cutout is 17.5 mm</p>	BKF 8-8-*/18.375/NPT	BSF 8-8-*/18.375/NPT	8x18 AWG, 105 °C, 125 VAC/VDC, 7 A, 8-Wire DC applications	<p>Female</p> <p>Male</p>

We reserve the right to make technical alterations without prior notice.

* Length in meters. Standard lead length is 0.5 meters. Consult factory for other lengths.
 Standard housing material is nickel plated brass "BSF..".
 To specify PVC jacketed cable, add "/S717" to the end of the part number.



12, 14 and 19-Pin Receptacles, Front Mount, 3/8-18 NPT Threads

- For use with Junction Box Home Run Cables
- IEC IP67 Protection



Connector Style	Female Part Number	Male Part Number	Features	Pinout	
<p>BKF ..3/8-18 NPT (12, 14, 19 pin)</p> <p>Typical panel cutout is 17.5 mm</p>	BKF 12-12-*/18.375/NPT	BSF 12-12-*/18.375/NPT	12x22 AWG, 105 °C, 125 VAC/VDC, 4 A, mates with 12-pin connectors, 12 conductors	<p>Female</p> <p>Male</p>	
				<p>BKF 14-10-*/18.375/NPT</p>	<p>BSF 14-10-*/18.375/NPT</p>
<p>BKF 14-12-*/18.375/NPT</p>	<p>BSF 14-12-*/18.375/NPT</p>	12x22 AWG, 105 °C, 30 VAC/VDC, 3 A, mates with 14-pin connectors, 12 conductors	<p>Male</p>		
			<p>BSF ..3/8-18 NPT (12, 14, 19 pin)</p> <p>Typical panel cutout is 17.5 mm</p>	BKF 14-14-*/18.375/NPT	BSF 14-14-*/18.375/NPT
<p>BKF 19-19-*/18.375/NPT</p>	BSF 19-19-*/18.375/NPT	19x22 AWG, 105 °C, 30 VAC/VDC, 3 A, mates with 19-pin connectors, 19 conductors			

We reserve the right to make technical alterations without prior notice.

Receptacles

* Length in meters. Standard lead length is 0.5 meters. Consult factory for other lengths. Standard housing material is nickel plated brass "BSF..". To specify PVC jacketed cable, add "/S717" to the end of the part number.

5 - 8 Wire Receptacles, Rear Mount

- IEC IP67 Protection



Connector Style	Female Part Number	Male Part Number	Features	Pinout
<p>BKFD .. (5-8 pin)</p> <p>Typical panel cutout is 18 x 17 mm</p>	BKFD 5-5-*	BSFD 5-5-*	5x20 AWG, 105 °C, 300 VAC/VDC, 8 A, 5-Wire DC application	<p>Female</p> <p>Male</p>
	BKFD 6-6-*	BSFD 6-6-*	6x20 AWG, 105 °C, 300 VAC/VDC, 7 A, 6-Wire DC application	<p>Female</p> <p>Male</p>
<p>BSFD .. (5-8, 12-19 pin)</p> <p>Typical panel cutout is 18 x 17 mm</p>	BKFD 7-7-*	BSFD 7-7-*	7x20 AWG, 105 °C, 125 VAC/VDC, 7 A, 7-Wire DC application	<p>Female</p> <p>Male</p>
	BKFD 8-8-*	BSFD 8-8-*	8x20 AWG, 105 °C, 125 VAC/VDC, 7 A, 8-Wire DC application	<p>Female</p> <p>Male</p>

We reserve the right to make technical alterations without prior notice.

* Length in meters. Standard lead lengths is 0.5 meters. Consult factory for other lengths.
Standard housing material is nickel plated brass.
To specify PVC jacketed cable, add "/S717" to the end of the part number.



12, 14 and 19-Pin Receptacles, Rear Mount

- For use with Junction Box Home Run Cables
- IEC IP67 Protection



Connector Style	Female Part Number	Male Part Number	Features	Pinout
<p>BKFD ..(12, 14, 19 pin)</p> <p>Typical panel cutout is 18 x 17 mm</p>	BKFD 12-12-*	BSFD 12-12-*	12x24 AWG, 105 °C, 125 VAC/VDC, 4 A, mates with 12-pin connectors, 12 conductors	<p>Female</p> <p>Male</p>
	BKFD 14-10-*	BSFD 14-10-*	10x24 AWG, 105 °C, 30 VAC/VDC, 3 A, mates with 14-pin connectors, 10 conductors	<p>Female</p>
	BKFD 14-12-*	BSFD 14-12-*	12x24 AWG, 105 °C, 30 VAC/VDC, 3 A, mates with 14-pin connectors, 12 conductors	<p>Female</p> <p>Male</p>
	BKFD 14-14-*	BSFD 14-14-*	14x24 AWG, 105 °C, 30 VAC/VDC, 3 A, mates with 14-pin connectors, 14 conductors	<p>Male</p>
	<p>BSFD ..(12, 14, 19 pin)</p> <p>Typical panel cutout is 18 x 17 mm</p>	BKFD 19-19-*	BSFD 19-19-*	19x24 AWG, 105 °C, 30 VAC/VDC, 3 A, mates with 19-pin connectors, 19 conductors

We reserve the right to make technical alterations without prior notice.

Receptacles

* Length in meters. Standard lead lengths is 0.5 meters. Consult factory for other lengths. Standard housing material is nickel plated brass. To specify PVC jacketed cable, add "/S717" to the end of the part number.

• IEC IP67 Protection



Connector Style	Female Part Number	Male Part Number	Features	Pinout
<p>BKFD .. M18 (5-8 pin)</p> <p>Typical panel cutout is 18.6 mm</p>	BKFD 5-5-*/M18	BSFD 5-5-*/M18	5x18 AWG, 105 °C, 300 VAC/VDC, 8 A, 5-Wire DC applications	<p>Female</p> <p>Male</p>
	BKFD 6-6-*/M18	BSFD 6-6-*/M18	6x18 AWG, 105 °C, 300 VAC/VDC, 7 A, 6-Wire DC applications	<p>Female</p> <p>Male</p>
<p>BSFD.. M18 (5-8 pin)</p> <p>Typical panel cutout is 18.6 mm</p>	BKFD 7-7-*/M18	BSFD 7-7-*/M18	7x18 AWG, 105 °C, 125 VAC/VDC, 7 A, 7-Wire DC applications	<p>Female</p> <p>Male</p>
	BKFD 8-8-*/M18	BSFD 8-8-*/M18	8x18 AWG, 105 °C, 125 VAC/VDC, 7 A, 8-Wire DC applications	<p>Female</p> <p>Male</p>

We reserve the right to make technical alterations without prior notice.

* Length in meters. Standard lead length is 0.5 meter. Consult factory for other lengths.
 Standard housing material is nickel plated brass. "BSFDV.." indicates stainless steel.
 To specify PVC jacketed cable, add "/S717" to the end of the part number.

12, 14 and 19-Pin Receptacles, Rear Mount, M18 Threads

- IEC IP67 Protection



Connector Style	Female Part Number	Male Part Number	Features	Pinout		
<p>BKFD .. M18 (12, 14, 19 pin)</p> <p>Typical panel cutout is 18.6 mm</p>	BKFD 12-12-*/M18	BSFD 12-12-*/M18	12x22 AWG, 105 °C, 125 VAC/VDC, 4 A, mates with 12-pin connectors, 12 conductors	A. BN B. BU C. WH D. GN E. YE F. GY	G. PK H. RD J. BK K. OG L. TN M. VT	<p>Female</p> <p>Male</p>
	BKFD 14-10-*/M18	BSFD 14-10-*/M18	10x22 AWG, 105 °C, 30 VAC/VDC, 3 A, mates with 14-pin connectors, 10 conductors	C. GY E. GN G. BK M. BN N. PK	O. YE P. WH R. RD S. VT U. BU	<p>Female</p>
<p>BSFD.. M18 (12, 14, 19 pin)</p> <p>Typical panel cutout is 18.6 mm</p>	BKFD 14-12-*/M18	BSFD 14-12-*/M18	12x22 AWG, 105 °C, 30 VAC/VDC, 3 A, mates with 14-pin connectors, 12 conductors	C. OG E. BK G. GN J. GY M. BN N. TN	O. VT P. RD R. WH S. YE T. PK U. BU	<p>Male</p>
	BKFD 14-14-*/M18	BSFD 14-14-*/M18	14x22 AWG, 105 °C, 30 VAC/VDC, 3 A, mates with 14-pin connectors, 14 conductors	A. BN C. RD/BU E. BK G. PK J. GN L. BU M. OG	N. GY/BN O. VT P. WH R. RD S. GY T. YE U. TN	<p>Female</p>
<p>BKFD 19-19-*/M18</p>	BKFD 19-19-*/M18	BSFD 19-19-*/M18	19x22 AWG, 105 °C, 30 VAC/VDC, 3 A, mates with 19-pin connectors, 19 conductors	A. BU B. GY/PK C. RD/BU D. WH/GN E. BK F. BN/GN G. PK H. WH/YE I. GN K. YE/BN	L. BN M. OG N. GY/BN O. VT P. WH R. RD S. GY T. YE U. TN	<p>Female</p> <p>Male</p>

We reserve the right to make technical alterations without prior notice.

Receptacles

* Length in meters. Standard lead length is 0.5 meter. Consult factory for other lengths. Standard housing material is nickel plated brass. "BSFDV.." indicates stainless steel. To specify PVC jacketed cable, add "/S717" to the end of the part number.

5 - 8 Pin Receptacles, Rear Mount, PCB Pins

- Locknuts and O-rings included
- Easy Keyway Orientation
- IEC IP67 Protection

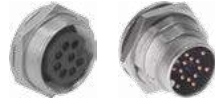

Connector Style	Female Part Number	Male Part Number	Features	Pinout
	BKFD 5-PCB	BSFD 5-PCB	Nickel plated brass, 5-pin PCB pins, 105 °C, 60 V, 5 A, M18 x .75 threads, mates with 5-pin cordsets	
	BKFD 6-PCB	BSFD 6-PCB	Nickel plated brass, 5-pin PCB pins, 105 °C, 250 V, 5 A, M18 x .75 threads, mates with 6-pin cordsets	
	BKFD 7-PCB	BSFD 7-PCB	Nickel plated brass, 5-pin PCB pins, 105 °C, 60 V, 5 A, M18 x .75 threads, mates with 7-pin cordsets	
	BKFD 8-PCB	BSFD 8-PCB	Nickel plated brass, 5-pin PCB pins, 105 °C, 60 V, 5 A, M18 x .75 threads, mates with 8-pin cordsets	

We reserve the right to make technical alterations without prior notice.

5-Pin PCB Layout

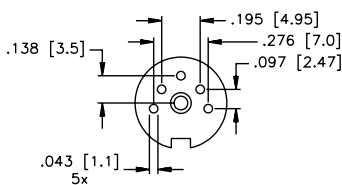

6-Pin PCB Layout

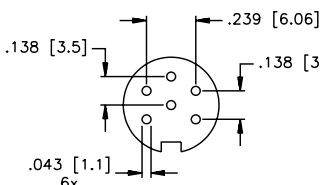

7-Pin PCB Layout

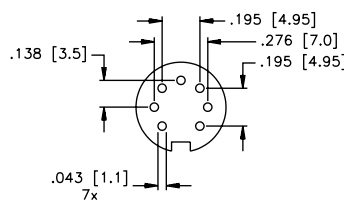

8-Pin PCB Layout

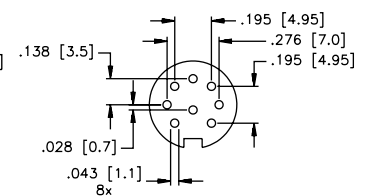

12, 14 and 19-Pin Receptacles, Rear Mount, PCB Pins

- Locknuts and O-rings included
- Easy Keyway Orientation
- IEC IP67 Protection



We reserve the right to make technical alterations without prior notice.

Connector Style	Female Part Number	Male Part Number	Features	Pinout
<p>BKFD ..PCB (12, 14, 19 pin)</p>	BKFD 12-PCB	BSFD 12-PCB	Nickel plated brass, 12-pin PCB pins, 105 °C, 60 V, 3 A, M18 x .75 threads, mates with 12-pin cordsets	<p>Female</p> <p>Male</p>
<p>BKFD 14-PCB</p>	BKFD 14-PCB	BSFD 14-PCB	Nickel plated brass, 14-pin PCB pins, 105 °C, 60 V, 3 A, M18 x .75 threads, mates with 14-pin cordsets	<p>Female</p> <p>Male</p>
<p>BSFD ..PCB (12, 14, 19 pin)</p>	BKFD 19-PCB	BSFD 19-PCB	Nickel plated brass, 19-pin PCB pins, 105 °C, 60 V, 3 A, M18 x .75 threads, mates with 19-pin cordsets	<p>Female</p> <p>Male</p>

5-Pin PCB Layout

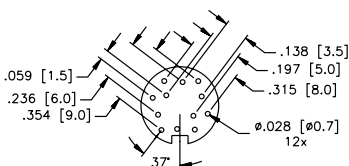

7-Pin PCB Layout

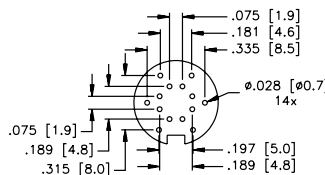

8-Pin PCB Layout

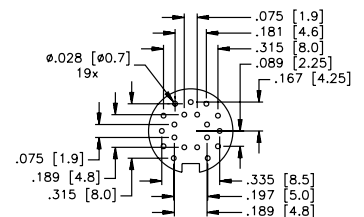

Receptacles

12, 14 and 19-Pin Receptacles, Solder Cups, Front and Rear Mount

- Facilitates Field Replacements



Connector Style	Female Part Number	Male Part Number	Features	Pinout
<p>BKF (12, 14, 19 pin)</p>	BKF 12	BSF 12	Nickel plated brass, solder cup, accepts up to 12x24 AWG conductors, 95 °C, 125 V, 4 A, mates with Picofast® junction boxes, front mount	<p>Female</p>
	BKFD 12	BSFD 12	Nickel plated brass, solder cup, accepts up to 12x24 AWG conductors, 95 °C, 125 V, 3 A, mates with Picofast junction boxes, rear mount	<p>Male</p>
<p>BKFD (12, 14, 19 pin)</p>	BKF 14	BSF 14	Nickel plated brass, solder cup, accepts up to 14x24 AWG conductors, 95 °C, 125 V, 3 A, mates with Picofast junction boxes, front mount	<p>Female</p>
	BKFD 14	BSFD 14	Nickel plated brass, solder cup, accepts up to 14x24 AWG conductors, 95 °C, 125 V, 3 A, mates with Picofast junction boxes, rear mount	<p>Male</p>
<p>BSF (12, 14, 19 pin)</p>	BKF 19	BSF 19	Nickel plated brass, solder cup, accepts up to 19x24 AWG conductors, 95 °C, 125 V, 3 A, mates with Picofast junction boxes, front mount	<p>Female</p>
<p>BSFD (12, 14, 19 pin)</p>	BKFD 19	BSFD 19	Nickel plated brass, solder cup, accepts up to 19x24 AWG conductors, 95 °C, 30 V, 3 A, mates with Picofast junction boxes, rear mount	<p>Male</p>

We reserve the right to make technical alterations without prior notice.

5 - 8 Pin Field Wireable, In-line Connectors

- For use with Custom Wiring or Junction Boxes
- IEC IP67 Protection



Connector Style	Female Part Number	Male Part Number	Features	Pinout
<p>BK ..</p>	BK 5-0	BS 5-0	Nylon PG 9 cable gland, accepts 6-8 mm cable diameter, solder cup, accepts up to 5x18 AWG conductors, 85 °C, 60 VAC/DC, 6 A, Mates with 5-pin cordsets and receptacles	<p>Female</p> <p>Male</p>
	BK 6-0	BS 6-0	Nylon PG 9 cable gland, accepts 6-8 mm cable diameter, solder cup, accepts up to 6x18 AWG conductors, 85 °C, 60 VAC/DC, 3 A, Mates with 6-pin cordsets and receptacles	<p>Female</p> <p>Male</p>
	BK 7-0	BS 7-0	Nylon PG 9 cable gland, accepts 6-8 mm cable diameter, solder cup, accepts up to 7x18 AWG conductors, 85 °C, 60 VAC/DC, 3 A, Mates with 7-pin cordsets and receptacles	<p>Female</p> <p>Male</p>
	BK 8-0	BS 8-0	Nylon PG 9 cable gland, accepts 6-8 mm cable diameter, solder cup, accepts up to 8x18 AWG conductors, 85 °C, 60 VAC/DC, 3 A, Mates with 8-pin cordsets and receptacles	<p>Female</p> <p>Male</p>

We reserve the right to make technical alterations without prior notice.

Accessories

12-pin Field Wireable, In-line Connectors

- Standard Nylon and Shielded
- IEC IP67 Protection



Connector Style	Female Part Number	Male Part Number	Features	Pinout
<p>BK ..</p> <p>BS ..</p>	BK 12-0	BS 12-0	Nylon PG 9 cable gland, accepts 6-8 mm cable diameter solder cup, accepts up to 12x24 AWG conductors, 85 °C, 60 VDC/VAC, 3 A, mates with 12-pin cordsets and receptacles	<p>Female</p>
<p>BKS ..</p> <p>BSS ..</p>	BKS 12-0	BSS 12-0		

We reserve the right to make technical alterations without prior notice.

14 and 19-Pin Field Wireable, In-line Connectors

- Male Connectors
- For use with Custom Wiring or Junction Boxes
- IEC IP67 Protection



Connector Style	Female Part Number	Male Part Number	Features	Pinout
<p>BK ..</p>	BK 14-0	BS 14-0	Nylon PG 9 cable gland, accepts 6-8 mm cable diameter, solder cup, accepts up to 14x24 AWG conductors, 85 °C, 60 VAC/DC, 3 A, Mates with Picofast® junction boxes, unshielded	<p>Female</p> <p>Male</p>
<p>BS ..</p>	BK 19-0	BS 19-0	Nylon PG 9 cable gland, accepts 6-8 mm cable diameter, solder cup, accepts up to 19x24 AWG conductors, 85 °C, 60 VAC/DC, 3 A, Mates with Picofast junction boxes, unshielded	<p>Female</p> <p>Male</p>
<p>WBK ..</p>	WBK 14-0	WBS 14-0	Nylon PG 9 cable gland, accepts 6-8 mm cable diameter, solder cup, accepts up to 14x24 AWG conductors, 85 °C, 60 VAC/DC, 3 A, Mates with Picofast junction boxes, unshielded	<p>Female</p> <p>Male</p>
<p>WBS ..</p>	WBK 19-0	WBS 19-0	Nylon PG 9 cable gland, accepts 6-8 mm cable diameter, solder cup, accepts up to 19x24 AWG conductors, 85 °C, 60 VAC/DC, 3 A, Mates with Picofast junction boxes, unshielded	<p>Male</p>

We reserve the right to make technical alterations without prior notice.

Accessories

Closure Caps



Connector Style	Part Number	Features
	BKK-CC	Nylon, M16 threads, 4 1/2 inch plastic lanyard and 3/4 inch loop, mates to male cordsets, receptacles, or junction boxes
	BKFK-CC	Nylon, M16 threads, 2 3/4 inch plastic lanyard and #10 eye-let, mates to male cordsets, receptacles, or junction boxes
	BSK-CC	Nylon, M16 threads, 4 1/2 inch plastic lanyard and 3/4 inch loop, mates to female cordsets, receptacles, or junction boxes
	BSFK-CC	Nylon, M16 threads, 2 3/4 inch plastic lanyard and #10 eye-let, mates to female cordsets, receptacles, or junction boxes
	BKM-CC	Nickel plated brass, M16 threads, 6" lanyard, mates with male cordsets and receptacles
	BKF-CC	Nickel plated brass, M16 threads, 6" lanyard with eyelet, mates with male cordsets and receptacles
	BKM-MC	Nickel plated brass, M16 threads, no lanyard, mates with male cordsets and receptacles
	BSM-CC	Nickel plated brass, M16 threads, 6" lanyard
	BSF-CC	Nickel plated brass, M16 threads, 6" lanyard with eyelet
	BSM-MC	Nickel plated brass, M16 threads, no lanyard

We reserve the right to make technical alterations without prior notice.

Part Number Keys	H2
Cordsets	H5
Receptacles	H19
Field Wireables	H32
Conduit Adapters	H35
Accessories	H36

Features

- M23 and M27 threaded connectors
- M23 available in 12, 16 and 19-pin
- M27 available in 26 and 28-pin
- Up to 9 Amps, 300 Volts rated
- High density
- IEC IP67 protection



Cordset Part Number key

Part Number Keys are to assist in IDENTIFICATION ONLY. Consult factory for catalog items not identified.

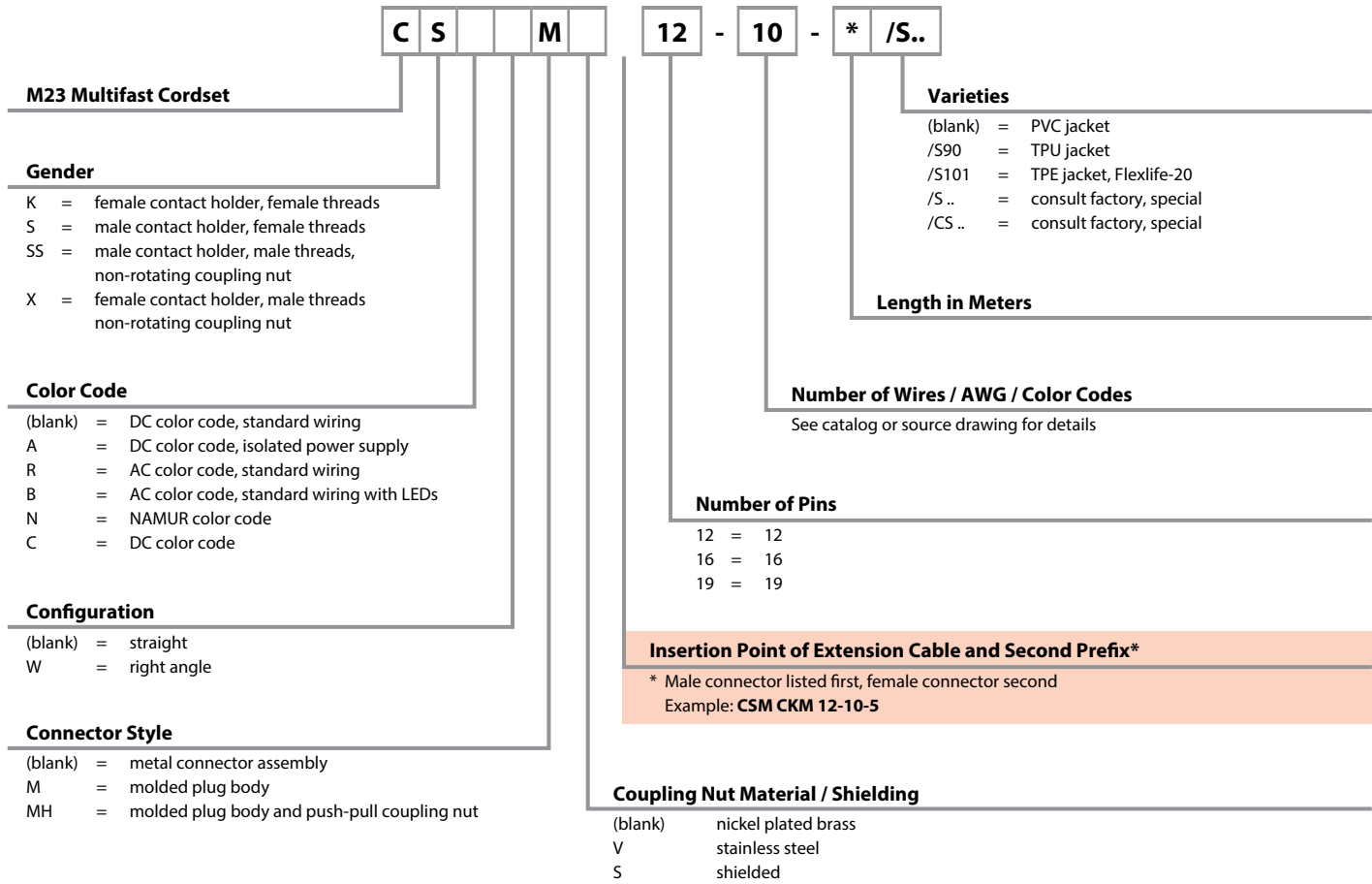

Extension Examples

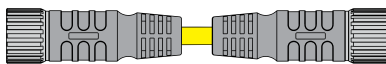

C S M 12 - 10 - 5 /S..

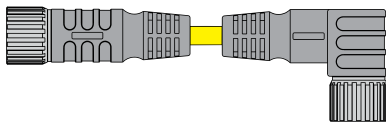

C K M C K W M 12 - 10 - 5 /S..

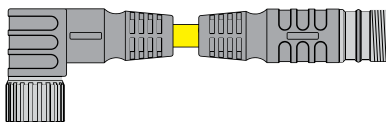

C K W M C S S M 12 - 10 - 5 /S..

Receptacle Part Number Key

Part Number Keys are to assist in IDENTIFICATION ONLY. Consult factory for catalog items not identified.

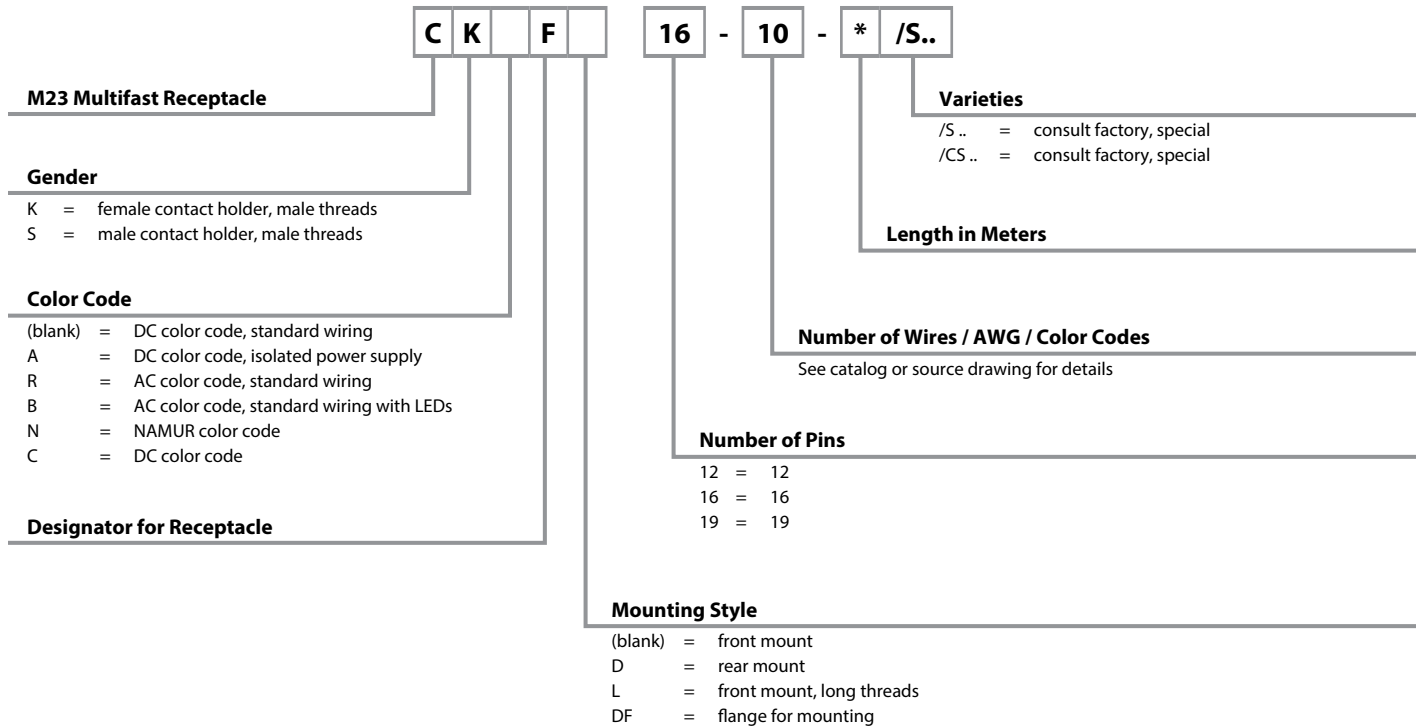

multifast®

Cordset Part Number Key

Part Number Keys are to assist in IDENTIFICATION ONLY. Consult factory for catalog items not identified.



M27 Multifast Cordset

Gender

- K = female contact holder, female threads
- S = male contact holder, female threads
- SS = male contact holder, male threads
non-rotating coupling nut

Connector Style

- (blank) = metal connector assembly
- M = Dmolded plug body

Insertion Point of Extension Cable and Second Prefix*

- * Male connector listed first, female connector second
- Example: **DSM DKM 26-631-5**

Varieties

- /S.. = consult factory, special
- /CS.. = consult factory, special

Length in Meters

Number of Wires / AWG / Color Codes

- 631 (for 26-pin) = 25x22 AWG, 1x22 AWG drain
- 061 (for 28-pin) = 27x22 AWG, 1x22 AWG drain
- 381 (for 26-pin) = 25x22 AWG, 1x24 AWG drain, braided shield

Number of Pins

- 26 = 26
- 28 = 28

Receptacle Part Number Key

Part Number Keys are to assist in IDENTIFICATION ONLY. Consult factory for catalog items not identified.



M27 Multifast Cordset

Gender

- K = female contact holder, male threads
- S = male contact holder, male threads

Designator for Receptacle

Varieties

- /S.. = consult factory, special
- /CS.. = consult factory, special

Length in Meters

Number of Wires

- 25 = 25 (for 26-pin)
- 27 = 27 (for 28-pin)

Number of Pins

- 26 = 26
- 28 = 28

12-Pin Cordsets, DC Color Code, Standard Wiring

- For Eurofast® Junction Boxes and Multi-Conductor Applications
- IEC IP67 Protection
- 300 V, 6 A



Connector Style	Female Part Number	Male Part Number	Features	Pinout
<p>CKM ..</p>	CKM 12-7-* CKWM 12-7-*	CSM 12-7-* CSWM 12-7-*	ITC/PLTC PVC Yellow, 7x18 AWG, 105 °C, 8.4 mm OD, Cable #RF50637- <i>*M</i> , 4 port, 1 signal per port, Flexlife®	<p>Female</p>
	CKM 12-7-*/S90 CKWM 12-7-*/S90	CSM 12-7-*/S90 CSWM 12-7-*/S90	AWM TPU Yellow, 7x18 AWG, 90 °C, 6.7 mm OD, Cable #RF50676- <i>*M</i> , 4 port, 1 signal per port, Cut/Abrasion Immune	
<p>CKWM..</p>	CKM 12-9-* CKWM 12-9-*	CSM 12-9-* CSWM 12-9-*	ITC/PLTC PVC Yellow, 9x18 AWG, 105 °C, 9.6 mm OD, Cable #RF50636- <i>*M</i> , 6 port, 1 signal per port, Flexlife	
	CKM 12-9-*/S90 CKWM 12-9-*/S90	CSM 12-9-*/S90 CSWM 12-9-*/S90	AWM TPU Yellow, 9x18 AWG, 90 °C, 9.6 mm OD, Cable #RF50677- <i>*M</i> , 6 port, 1 signal per port, Cut/Abrasion Immune	
<p>CSM ..</p>	CKM 12-11-* CKWM 12-11-*	CSM 12-11-* CSWM 12-11-*	ITC/PLTC PVC Yellow, 11x18 AWG, 105 °C, 10.5 mm OD, Cable #RF51088- <i>*M</i> , 8 port, 1 signal per port, Flexlife	
	CKM 12-11-*/S90 CKWM 12-11-*/S90	CSM 12-11-*/S90 CSWM 12-11-*/S90	AWM TPU Yellow, 11x18 AWG, 90 °C, 10 mm OD, Cable #RF50678- <i>*M</i> , 8 port, 1 signal per port, Cut/Abrasion Immune	
<p>CSWM ..</p>	CKM 12-12-*/S101 CKWM 12-12-*/S101	CSM 12-12-*/S101 CSWM 12-12-*/S101	AWM TPE Yellow, 12x18 AWG, 105 °C, 11.2 mm OD, Cable #RF50915- <i>*M</i> 8 port, Flexlife-20, High Flex - Over 20 million cycles	
	CKM 12-12-*/S817 CKWM 12-12-*/S817	CSM 12-12-*/S817 CSWM 12-12-*/S817	ITC/PLTC PVC Yellow, 12x18 AWG, 105 °C, 11.2 mm OD, Cable #RF50606- <i>*M</i> , Flexlife	

Cordsets

We reserve the right to make technical alterations without prior notice.

* Length in meters.
 Standard cable lengths are 5 and 10 meters. Consult factory for other lengths.
 Standard coupling nut material is nickel plated brass.. "CKM.."; "CKMV.." indicates stainless steel coupling nut.

- For Eurofast® Junction Boxes and Multi-Conductor Applications
- IEC IP67 Protection
- 300 V, 6 A



Connector Style	Male Part Number	Features	Pinout
<p>CSSM ..</p> <p>3.335 [84.7]</p> <p>0.929 [23.6]</p> <p>M23x1</p> <p>Non-rotating coupling nut</p> <p>CSSWM ..</p> <p>2.887 [73.3]</p> <p>2.049 [52.0]</p> <p>M23x1</p> <p>0.929 [23.6]</p> <p>Non-rotating coupling nut</p>	CSSM 12-7-* CSSWM 12-7-*	ITC/PLTC PVC Yellow, 7x18 AWG, 105 °C, 8.4 mm OD, Cable #RF50637-*M, 4 port, 1 signal per port, Flexlife®	1. BN 3. BU 4. WH 6. GN 7. YE 8. GY 12. GN/YE
	CSSM 12-7-*/S90 CSSWM 12-7-*/S90	AWM TPU Yellow, 7x18 AWG, 90 °C, 6.7 mm OD, Cable #RF50676-*M, 4 port, 1 signal per port, Cut/Abrasion Immune	1. BN 3. BU 4. WH 6. GN 7. YE 8. GY 12. GN/YE
	CSSM 12-9-* CSSWM 12-9-*	ITC/PLTC PVC Yellow, 9x18 AWG, 105 °C, 9.6 mm OD, Cable #RF50636-*M, 6 port, 1 signal per port, Flexlife	1. BN 3. BU 4. WH 6. GN 7. YE 8. GY 9. PK 10. RD 12. GN/YE
	CSSM 12-9-*/S90 CSSWM 12-9-*/S90	AWM TPU Yellow, 9x18 AWG, 90 °C, 9.6 mm OD, Cable #RF50677-*M, 6 port, 1 signal per port, Cut/Abrasion Immune	1. BN 3. BU 4. WH 5. GN 6. YE 7. GY 8. PK 9. RD 10. BK 11. VT 12. GN/YE
	CSSM 12-11-* CSSWM 12-11-*	ITC/PLTC PVC Yellow, 11x18 AWG, 105 °C, 10.5 mm OD, Cable #RF51088-*M, 8 port, 1 signal per port, Flexlife	1. BN 2. BU 3. WH 4. GN/YE 5. OG 6. YE 7. GY 8. PK 9. RD 10. BN/WH 11. BU/WH 12. GN/WH
	CSSM 12-11-*/S90 CSSWM 12-11-*/S90	AWM TPU Yellow, 11x18 AWG, 90 °C, 10 mm OD, Cable #RF50678-*M, 8 port, 1 signal per port, Cut/Abrasion Immune	1. BN 2. BU 3. WH 4. GN/YE 5. OG 6. YE 7. GY 8. PK 9. RD 10. BN/WH 11. BU/WH 12. GN/WH
CSSM 12-12-*/S101 CSSWM 12-12-*/S101	AWM TPE Yellow, 12x18 AWG, 105 °C, 11.2 mm OD, Cable #RF50915-*M 8 port, Flexlife-20, High Flex - Over 20 million cycles	1. BN 2. BU 3. WH 4. GN/YE 5. OG 6. YE 7. GY 8. PK 9. RD 10. BN/WH 11. BU/WH 12. GN/WH	
CSSM 12-12-*/S817 CSSWM 12-12-*/S817	ITC/PLTC PVC Yellow, 12x18 AWG, 105 °C, 11.2 mm OD, Cable #RF50606-*M, Flexlife	1. BN 2. BU 3. WH 4. GN/YE 5. OG 6. YE 7. GY 8. PK 9. RD 10. BN/WH 11. BU/WH 12. GN/WH	

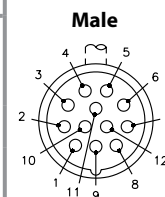

We reserve the right to make technical alterations without prior notice.

* Length in meters.
 Standard cable lengths are 5 and 10 meters. Consult factory for other lengths.
 Standard coupling nut material is nickel plated brass.. "CSSM..".

19-Pin Cordsets, DC Color Code, Standard Wiring

- For Eurofast® Junction Boxes and Multi-Conductor Applications
- IEC IP67 Protection
- 150 V, 9 A (18 AWG) & 2 A (22 AWG)



We reserve the right to make technical alterations without prior notice.

Connector Style	Female Part Number	Male Part Number	Features	Pinout
<p>CKM ..</p>	CKM 19-11-* CKWM 19-11-*	CSM 19-11-* CSWM 19-11-*	ITC/PLTC PVC Yellow, 3x18, 8x22 AWG, 105 °C, 8.5 mm OD, Cable #RF50624-*M, 4-port, 2 signals per port, Flexlife®	<p>Female</p>
	CKM 19-11-*/S90 CKWM 19-11-*/S90	CSM 19-11-*/S90 CSWM 19-11-*/S90	AWM TPU Yellow, 3x18, 8x22 AWG, 90 °C, 8.4 mm OD, Cable #RF50718-*M, 4-port, 2 signals per port, Cut/Abrasion Immune	
<p>CKWM ..</p>	CKM 19-15-* CKWM 19-15-*	CSM 19-15-* CSWM 19-15-*	ITC/PLTC PVC Yellow, 3x18, 12x22 AWG, 105 °C, 8.5 mm OD, Cable #RF50625-*M, 6-port, 2 signals per port, Flexlife	<p>Male</p>
	CKM 19-15-*/S90 CKWM 19-15-*/S90	CSM 19-15-*/S90 CSWM 19-15-*/S90	AWM TPU Yellow, 3x18, 12x22 AWG, 90 °C, 8.4 mm OD, Cable #RF50818-*M, 6-port, 2 signals per port, Cut/Abrasion Immune	
<p>CSM ..</p>	CKM 19-19-* CKWM 19-19-*	CSM 19-19-* CSWM 19-19-*	ITC/PLTC PVC Yellow, 3x18, 16x22 AWG, 105 °C, 10.0 mm OD, Cable #RF50620-*M, 8 port, 2 signals per port, Flexlife	<p>Male</p>
	CKM 19-19-*/S90 CKWM 19-19-*/S90	CSM 19-19-*/S90 CSWM 19-19-*/S90	AWM TPU Yellow, 3x18, 16x22 AWG, 90 °C, 10.0 mm OD, Cable #RF50682-*M, 8 port, 2 signals per port Cut/Abrasion Immune	
<p>CSWM ..</p>	CKM 19-19-*/S101 CKWM 19-19-*/S101	CSM 19-19-*/S101 CSWM 19-19-*/S101	AWM TPE Yellow, 3x18, 16x22 AWG, 105 °C, 11.2 mm OD, Cable #RF50916-*M, 8 port, 2 signals per port, Flexlife-20, High Flex - Over 20 million cycles	

* Length in meters.
 Standard cable lengths are 5 and 10 meters. Consult factory for other lengths.
 Standard coupling nut material is nickel plated brass.. "CKM.."; "CKMV.." indicates stainless steel coupling nut.

Cordsets

- For Eurofast® Junction Boxes and Multi-Conductor Applications
- IEC IP67 Protection
- 150 V, 9 A (18 AWG) & 2 A (22 AWG)



Connector Style	Male Part Number	Features	Pinout
<p>CSSM ..</p> <p>3.335 [84.7] 0.929 [23.6]</p> <p>M23x1</p> <p>Non-rotating coupling nut</p> <p>CSSWM ..</p> <p>2.887 [73.3] 2.049 [52.0]</p> <p>M23x1 0.929 [23.6]</p> <p>Non-rotating coupling nut</p>	CSSM 19-11-* CSSWM 19-11-*	ITC/PLTC PVC Yellow, 3x18, 8x22 AWG, 105 °C, 8.5 mm OD, Cable #RF50624-*M, 4-port, 2 signals per port, Flexlife®	3. GY 4. RD/BU 5. GN 6. BU 7. GY/PK 8. WH/GN 12. GN/YE 14. BN/GN 15. WH 16. YE 19. BN
	CSSM 19-11-*/S90 CSSWM 19-11-*/S90	AWM TPU Yellow, 3x18, 8x22 AWG, 90 °C, 8.4 mm OD, Cable #RF50718-*M, 4-port, 2 signals per port, Cut/Abrasion Immune	7. GY/PK 8. WH/GN 12. GN/YE 14. BN/GN 15. WH 16. YE 19. BN
	CSSM 19-15-* CSSWM 19-15-*	ITC/PLTC PVC Yellow, 3x18, 12x22 AWG, 105 °C, 8.5 mm OD, Cable #RF50625-*M, 6-port, 2 signals per port, Flexlife	2. RD 3. GY 4. RD/BU 5. GN 6. BU 7. GY/PK 8. WH/GN 9. WH/YE 12. GN/YE 13. YE/BN 14. BN/GN 15. WH 16. YE 17. PK 19. BN
	CSSM 19-15-*/S90 CSSWM 19-15-*/S90	AWM TPU Yellow, 3x18, 12x22 AWG, 90 °C, 8.4 mm OD, Cable #RF50818-*M, 6-port, 2 signals per port, Cut/Abrasion Immune	13. YE/BN 14. BN/GN 15. WH 16. YE 17. PK 19. BN
	CSSM 19-19-* CSSWM 19-19-*	ITC/PLTC PVC Yellow, 3x18, 16x22 AWG, 105 °C, 10.0 mm OD, Cable #RF50620-*M, 8 port, 2 signals per port, Flexlife	1. VT 2. RD 3. GY 4. RD/BU 5. GN 6. BU 7. GY/PK 8. WH/GN 9. WH/YE 10. WH/GY 11. BK 12. GN/YE 13. YE/BN 14. BN/GN 15. WH 16. YE 17. PK 18. GY/BN 19. BN
	CSSM 19-19-*/S90 CSSWM 19-19-*/S90	AWM TPU Yellow, 3x18, 16x22 AWG, 90 °C, 10.0 mm OD, Cable #RF50682-*M, 8 port, 2 signals per port Cut/Abrasion Immune	10. WH/GY 11. BK 12. GN/YE 13. YE/BN 14. BN/GN 15. WH 16. YE 17. PK 18. GY/BN 19. BN
CSSM 19-19-*/S101 CSSWM 19-19-*/S101	AWM TPE Yellow, 3x18, 16x22 AWG, 105 °C, 11.2 mm OD, Cable #RF50916-*M, 8 port, 2 signals per port, Flexlife-20, High Flex - Over 20 million cycles	15. WH 16. YE 17. PK 18. GY/BN 19. BN	

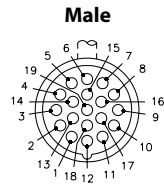

We reserve the right to make technical alterations without prior notice.

* Length in meters.
 Standard cable lengths are 5 and 10 meters. Consult factory for other lengths.
 Standard coupling nut material is nickel plated brass.. "CSSM..".

12 and 19-Pin Shielded Cordsets, DC Color Code, Standard Wiring

- Shield to Coupling Nut
- For Eurofast® Junction Boxes and Multi-Conductor Applications
- IEC IP67 Protection



Connector Style	Female Part Number	Male Part Number	Features	Pinout
<p>CKMS ..</p>	<p>CKMS 12-7-204-* CKWMS 12-7-204-*</p>	<p>CSMS 12-7-204-* CSWMS 12-7-204-*</p>	<p>ITC/PLTC PVC Yellow, 7x18 AWG, 105 °C, 300 V, 6 A, 8.4 mm OD, Cable #RF51204-*M 4-port, 1 signal per port, EMI/RFI Protection</p>	<p>1. BN 7. YE 2. N/C 8. GY 3. BU 9. N/C 4. WH 10. N/C 5. N/C 11. N/C 6. GN 12. GN/YE</p> <p>Female</p>
<p>CKWMS ..</p>	<p>CKMS 12-11-190-* CKWMS 12-11-190-*</p>	<p>CSMS 12-11-190-* CSWMS 12-11-190-*</p>	<p>ITC/PLTC PVC Yellow, 11x18 AWG, 105 °C, 300 V, 6 A, 11.2 mm OD, Cable #RF51190-*M, 8-port, 1 signal per port, EMI/RFI Protection</p>	<p>1. BN 7. GY 2. N/C 8. PK 3. BU 9. RD 4. WH 10. BK 5. GN 11. VT 6. YE 12. GN/YE</p> <p>Male</p>
<p>CSMS ..</p>	<p>CKMS 19-191-* CKWMS 19-191-*</p>	<p>CSMS 19-191-* CSWMS 19-191-*</p>	<p>PLTC PVC Yellow, 3x18, 16x22 AWG, 105 °C, 150 V, 9 A (18 AWG) & 2 A (22 AWG), 11.2 mm OD, Cable #RF51191-*M, 8 port, 2 signals per port, EMI/RFI Protection</p>	<p>1. VT 2. RD 3. GY 4. RD/BU 5. GN 6. BU 7. GY/PK 8. WH/GN 9. WH/YE 10. WH/GY 11. BK 12. GN/YE 13. YE/BN 14. BN/GN 15. WH 16. YE 17. PK 18. GY/BN 19. BN</p> <p>Female</p> <p>Male</p>
<p>CSWMS ..</p>	<p>CKMS 19-191-* CKWMS 19-191-*</p>	<p>CSMS 19-191-* CSWMS 19-191-*</p>	<p>PLTC PVC Yellow, 3x18, 16x22 AWG, 105 °C, 150 V, 9 A (18 AWG) & 2 A (22 AWG), 11.2 mm OD, Cable #RF51191-*M, 8 port, 2 signals per port, EMI/RFI Protection</p>	<p>1. VT 2. RD 3. GY 4. RD/BU 5. GN 6. BU 7. GY/PK 8. WH/GN 9. WH/YE 10. WH/GY 11. BK 12. GN/YE 13. YE/BN 14. BN/GN 15. WH 16. YE 17. PK 18. GY/BN 19. BN</p> <p>Female</p> <p>Male</p>

We reserve the right to make technical alterations without prior notice.

Cordsets

* Length in meters.
Standard cable lengths are 5 and 10 meters. Consult factory for other lengths.
Standard coupling nut material is nickel plated brass. "CKMS.."; "CKMSV.." indicates stainless steel coupling nut.

- For Eurofast® Junction Boxes and Multi-Conductor Applications
- IEC IP67 Protection
- 150 V, 6 A



Connector Style	Female Part Number	Male Part Number	Features	Pinout
<p>CKAM ..</p>	CKAM 16-10-* CKAWM 16-10-*	CSAM 16-10-* CSAWM 16-10-*	ITC/PLTC PVC Yellow, 10x18 AWG, 105 °C, 10.8 mm OD, Cable #RF50607- <i>*M</i> , 4-port, dual supply, Flexlife®	<ol style="list-style-type: none"> 1. BN 3. BU 4. WH 5. GN/YE 6. OG 7. YE 8. GY 11. BN/WH 13. BU/WH 15. GN/WH <p style="text-align: center;">Female</p>
<p>CKAWM ..</p>	CKAM 16-12-* CKAWM 16-12-*	CSAM 16-12-* CSAWM 16-12-*	ITC/PLTC PVC Yellow, 12x18 AWG, 105 °C, 11.2 mm OD, Cable #RF50606- <i>*M</i> , 6-port, dual supply, Flexlife	<ol style="list-style-type: none"> 1. BN 3. BU 4. WH 5. GN/YE 6. OG 7. YE 8. GY 9. PK 10. RD 11. BN/WH 13. BU/WH 15. GN/WH
<p>CSAM ..</p>	CKAM 16-14-* CKAWM 16-14-*	CSAM 16-14-* CSAWM 16-14-*	ITC/PLTC PVC Yellow, 14x18 AWG, 105 °C, 11.5 mm OD, Cable #RF50576- <i>*M</i> , 8-port, dual supply, Flexlife	<ol style="list-style-type: none"> 1. BN 3. BU 4. WH 5. GN/YE 6. OG 7. YE 8. GY 9. PK 10. RD 11. BN/WH 12. BK 13. BU/WH 14. VT 15. GN/WH <p style="text-align: center;">Male</p>
<p>CSAWM ..</p>				

We reserve the right to make technical alterations without prior notice.

* Length in meters.
Standard cable lengths are 5 and 10 meters. Consult factory for other lengths.
Standard coupling nut material is nickel plated brass.. "CKAM.."; "CKAMV.." indicates stainless steel coupling nut.

16-Pin Connectors, DC Color Code, Isolated Power Supply

- For Eurofast® Junction Boxes and Multi-Conductor Applications
- IEC IP67 Protection
- 150 V, 6 A



Connector Style	Male Part Number	Features	Pinout
<p>CSSAM..</p> <p>3.335 [84.7]</p> <p>0.929 [23.6]</p> <p>M2.5x1</p> <p>Non-rotating coupling nut</p>	<p>CSSAM 16-10-*</p> <p>CSSAWM 16-10-*</p>	<p>ITC/PLTC PVC Yellow, 10x18 AWG, 105 °C, 10.8 mm OD, Cable #RF50607-<i>*M</i>, 4-port, dual supply, Flexlife®</p>	<p>1. BN</p> <p>3. BU</p> <p>4. WH</p> <p>5. GN/YE</p> <p>6. OG</p> <p>7. YE</p> <p>8. GY</p> <p>11. BN/WH</p> <p>13. BU/WH</p> <p>15. GN/WH</p>
	<p>CSSAM 16-12-*</p> <p>CSSAWM 16-12-*</p>	<p>ITC/PLTC PVC Yellow, 12x18 AWG, 105 °C, 11.2 mm OD, Cable #RF50606-<i>*M</i>, 6-port, dual supply, Flexlife</p>	<p>Male</p>
	<p>CSSAM 16-14-*</p> <p>CSSAWM 16-14-*</p>	<p>ITC/PLTC PVC Yellow, 14x18 AWG, 105 °C, 11.5 mm OD, Cable #RF50576-<i>*M</i>, 8-port, dual supply, Flexlife</p>	
<p>CSSAWM..</p> <p>2.887 [73.3]</p> <p>2.049 [52.0]</p> <p>0.929 [23.6]</p> <p>M2.5x1</p> <p>Non-rotating coupling nut</p>	<p>1. BN</p> <p>3. BU</p> <p>4. WH</p> <p>5. GN/YE</p> <p>6. OG</p> <p>7. YE</p> <p>8. GY</p> <p>9. PK</p> <p>10. RD</p> <p>11. BN/WH</p> <p>12. BK</p> <p>13. BU/WH</p> <p>14. VT</p> <p>15. GN/WH</p>		

We reserve the right to make technical alterations without prior notice.

Cordsets

* Length in meters.
 Standard cable lengths are 5 and 10 meters. Consult factory for other lengths.
 Standard coupling nut material is nickel plated brass.. "CSSAM..".

12-Pin Cordsets, AC & DC Color Code

- For Eurofast®, Minifast®, and Microfast® Junction Boxes and Multi-Conductor Applications
- IEC IP67 Protection
- 300 V, 6 A



Connector Style	Female Part Number	Male Part Number	Features	Pinout
<p>CK*M..</p>	CKBM 12-7-* CKBWM 12-7-*	CSBM 12-7-* CSBWM 12-7-*	ITC/PLTC PVC Black, 7x18 AWG, 105 °C, 8.4 mm OD, Cable #RF50715-*M, 4-port, AC Color Code, Standard Wiring with LEDs, Flexlife®	1. WH/BK 2. BK 3. WH 4. RD 5. OG 6. BU 7. GN
<p>CK*WM..</p>	CKBM 12-11-* CKBWM 12-11-*	CSBM 12-11-* CSBWM 12-11-*	ITC/PLTC PVC Black, 11x18 AWG, 105 °C, 10.8 mm OD, Cable #RF50716-*M, 8-port, AC Color Code, Standard Wiring with LEDs, Flexlife	Female
<p>CS*M..</p>	CKCM 12-9-* CKCWM 12-9-*	CSCM 12-9-* CSCWM 12-9-*	ITC/PLTC PVC Yellow, 7x18 AWG, 105 °C, 8.4 mm OD, Cable #RF50637-*M, 4-port 1 signal per port, DC Color Code, Flexlife	1. WH 2. GN 3. YE 4. GY 5. PK 6. RD 10. BU 11. BN 12. GN/YE
<p>CS*WM..</p>	CKCM 12-9-*/S90 CKCWM 12-9-*/S90	CSCM 12-9-*/S90 CSCWM 12-9-*/S90	AWM TPU Yellow, 7x18 AWG, 90 °C, 6.7 mm OD, Cable #RF50676-*M, 4-port, 1 signal per port, DC Color Code, Cut/ Abrasion Immune	Male
<p>CS*M..</p>	CKCM 12-11-* CKCWM 12-11-*	CSCM 12-11-* CSCWM 12-11-*	ITC/PLTC PVC Yellow, 11x18 AWG, 105 °C, 10.5 mm OD, Cable #RF51088-*M, 8-port 1 Signal per port, DC Color Code, Flexlife	1. WH 2. GN 3. YE 4. GY 5. PK 6. RD 7. BK 8. VT 10. BU 11. BN 12. GN/YE
<p>CS*WM..</p>	CKCM 12-11-*/S90 CKCWM 12-11-*/S90	CSCM 12-11-*/S90 CSCWM 12-11-*/S90	AWM TPU Yellow, 11x18 AWG, 90 °C, 10 mm OD, Cable #RF50678-*M, 8-port, 1 signal per port, DC Color Code, Cut/ Abrasion Immune	1. WH 2. GN 3. YE 4. GY 5. PK 6. RD 7. BK 8. VT 10. BU 11. BN 12. GN/YE

We reserve the right to make technical alterations without prior notice.

* Length in meters.
 Standard cable lengths are 5 and 10 meters. Consult factory for other lengths.
 Standard coupling nut material is nickel plated brass.. "CKB(C)M.."; "CKB(C)MV.." indicates stainless steel coupling nut.

12-Pin Connectors, AC Color Code

- For Eurofast®, Minifast®, and Microfast® Junction Boxes and Multi-Conductor Applications
- IEC IP67 Protection
- 300 V, 6 A



Connector Style	Male Part Number	Features	Pinout
<p>CSS*M ..</p> <p>3.335 [84.7]</p> <p>0.929 [23.6]</p> <p>M23x1</p> <p>Non-rotating coupling nut</p>	<p>CSSRM 12-6-*</p> <p>CSSRWM 12-6-*</p>	<p>ITC/PLTC PVC Black, 6x18 AWG, 105 °C, 8.4 mm OD, Cable #RF50551-*M, 4-port, AC Color Code, Standard Wiring, Flexlife®</p>	<p>1. OG</p> <p>2. BU</p> <p>4. BK</p> <p>5. WH</p> <p>6. RD</p> <p>7. GN</p>
	<p>CSSRM 12-8-*</p> <p>CSSRWM 12-8-*</p>	<p>ITC/PLTC PVC Black, 8x18 AWG, 105 °C, 8.9 mm OD, Cable #RF50552-*M, 6-port, AC Color Code, Standard Wiring, Flexlife</p>	<p>1. OG</p> <p>2. BU</p> <p>3. YE</p> <p>4. BK</p> <p>5. WH</p> <p>6. RD</p> <p>7. GN</p> <p>8. BN</p>
<p>CSS*WM ..</p> <p>2.887 [73.3]</p> <p>2.049 [52.0]</p> <p>M23x1</p> <p>0.929 [23.6]</p> <p>Non-rotating coupling nut</p>	<p>CSSRM 12-10-*</p> <p>CSSRWM 12-10-*</p>	<p>ITC/PLTC PVC Black, 10x18 AWG, 105 °C, 10.8 mm OD, Cable #RF50553-*M, 8-port, AC Color Code, Standard Wiring, Flexlife</p>	<p>1. VT</p> <p>2. BU</p> <p>3. GY</p> <p>4. BK</p> <p>5. WH</p> <p>6. RD</p> <p>7. GN</p> <p>8. YE</p> <p>9. OG</p> <p>10. BN</p>
	<p>CSSBM 12-7-*</p> <p>CSSBWM 12-7-*</p>	<p>ITC/PLTC PVC Black, 7x18 AWG, 105 °C, 8.4 mm OD, Cable #RF50715-*M, 4-port, AC Color Code, Standard Wiring with LEDs, Flexlife</p>	<p>1. WH/BK</p> <p>2. BK</p> <p>3. WH</p> <p>4. RD</p> <p>5. OG</p> <p>6. BU</p> <p>7. GN</p>
	<p>CSSBM 12-11-*</p> <p>CSSBWM 12-11-*</p>	<p>ITC/PLTC PVC Black, 11x18 AWG, 105 °C, 10.8 mm OD, Cable #RF50716-*M, 8-port, AC Color Code, Standard Wiring with LEDs, Flexlife</p>	<p>1. OG</p> <p>2. BU</p> <p>3. WH/BK</p> <p>4. RD/BK</p> <p>5. GN/BK</p> <p>6. OG/BK</p> <p>7. BU/BK</p> <p>9. GN</p> <p>10. RD</p> <p>11. WH</p> <p>12. BK</p>

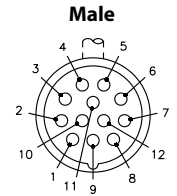

We reserve the right to make technical alterations without prior notice.

Cordsets

* Length in meters.
 Standard cable lengths are 5 and 10 meters. Consult factory for other lengths.
 Standard coupling nut material is nickel plated brass.. "CSSR(B)M..".

- For Eurofast® Junction Boxes and Multi-Conductor Applications
- IEC IP67 Protection



Connector Style	Female Part Number	Male Part Number	Features	Pinout																
<p>CK*M..</p>	CKRM 12-6-* CKRWM 12-6-*	CSRM 12-6-* CSRWM 12-6-*	ITC/PLTC PVC Black, 6x18 AWG, 105 °C, 8.4 mm OD, Cable #RF50551-*M, 4-port, AC Color Code, Standard Wiring, Flexlife®	<table border="0"> <tr> <td>1. OG</td> <td>5. WH</td> </tr> <tr> <td>2. BU</td> <td>6. RD</td> </tr> <tr> <td>4. BK</td> <td>7. GN</td> </tr> </table>	1. OG	5. WH	2. BU	6. RD	4. BK	7. GN										
	1. OG	5. WH																		
2. BU	6. RD																			
4. BK	7. GN																			
CKRM 12-8-* CKRWM 12-8-*	CSRM 12-8-* CSRWM 12-8-*	ITC/PLTC PVC Black, 8x18 AWG, 105 °C, 8.9 mm OD, Cable #RF50552-*M, 6-port, AC Color Code, Standard Wiring, Flexlife	<table border="0"> <tr> <td>1. OG</td> <td>5. WH</td> </tr> <tr> <td>2. BU</td> <td>6. RD</td> </tr> <tr> <td>3. YE</td> <td>7. GN</td> </tr> <tr> <td>4. BK</td> <td>8. BN</td> </tr> </table>	1. OG	5. WH	2. BU	6. RD	3. YE	7. GN	4. BK	8. BN									
1. OG	5. WH																			
2. BU	6. RD																			
3. YE	7. GN																			
4. BK	8. BN																			
<p>CK*WM..</p>	CKRM 12-10-* CKRWM 12-10-*	CSRM 12-10-* CSRWM 12-10-*	ITC/PLTC PVC Black, 10x18 AWG, 105 °C, 10.8 mm OD, Cable #RF50553-*M, 8-port, AC Color Code, Standard Wiring, Flexlife	<table border="0"> <tr> <td>1. VT</td> <td>6. RD</td> </tr> <tr> <td>2. BU</td> <td>7. GN</td> </tr> <tr> <td>3. GY</td> <td>8. YE</td> </tr> <tr> <td>4. BK</td> <td>9. OG</td> </tr> <tr> <td>5. WH</td> <td>10. BN</td> </tr> </table>	1. VT	6. RD	2. BU	7. GN	3. GY	8. YE	4. BK	9. OG	5. WH	10. BN						
	1. VT	6. RD																		
2. BU	7. GN																			
3. GY	8. YE																			
4. BK	9. OG																			
5. WH	10. BN																			
CKNM 12-9-* CKNWM 12-9-*	CSNM 12-9-* CSNWM 12-9-*	ITC/PLTC PVC Blue, 9x22 AWG, 105 °C, 300 V, 3 A, 6.9 mm OD, Cable #RF50741-*M, 4 port, Namur, 1 isolated circuit per port or 2 circuits per port with common positive, Flexlife	<table border="0"> <tr> <td>1. BN</td> <td>6. OG</td> </tr> <tr> <td>2. WH</td> <td>7. BU</td> </tr> <tr> <td>3. BK</td> <td>8. YE</td> </tr> <tr> <td>4. GN</td> <td>9. VT</td> </tr> <tr> <td>5. RD</td> <td></td> </tr> </table>	1. BN	6. OG	2. WH	7. BU	3. BK	8. YE	4. GN	9. VT	5. RD								
1. BN	6. OG																			
2. WH	7. BU																			
3. BK	8. YE																			
4. GN	9. VT																			
5. RD																				
<p>CS*M..</p>	CKNM 16-16-* CKNWM 16-16-*	CSNM 16-16-* CSNWM 16-16-*	ITC/PLTC PVC Blue, 16x22 AWG, 105 °C, 300 V, 3 A, 8.3 mm OD, Cable #RF50744-*M, 4 port, 2 isolated circuits per port, Flexlife	<table border="0"> <tr> <td>1. WH</td> <td>9. VT</td> </tr> <tr> <td>2. BK</td> <td>10. GY</td> </tr> <tr> <td>3. GN</td> <td>11. PK</td> </tr> <tr> <td>4. RD</td> <td>12. TN</td> </tr> <tr> <td>5. OG</td> <td>13. WH/BK</td> </tr> <tr> <td>6. BU</td> <td>14. WH/GN</td> </tr> <tr> <td>7. BN</td> <td>15. WH/RD</td> </tr> <tr> <td>8. YE</td> <td>16. WH/BU</td> </tr> </table>	1. WH	9. VT	2. BK	10. GY	3. GN	11. PK	4. RD	12. TN	5. OG	13. WH/BK	6. BU	14. WH/GN	7. BN	15. WH/RD	8. YE	16. WH/BU
	1. WH	9. VT																		
2. BK	10. GY																			
3. GN	11. PK																			
4. RD	12. TN																			
5. OG	13. WH/BK																			
6. BU	14. WH/GN																			
7. BN	15. WH/RD																			
8. YE	16. WH/BU																			
<p>CS*WM..</p>																				

We reserve the right to make technical alterations without prior notice.

* Length in meters.
 Standard cable lengths are 5 and 10 meters. Consult factory for other lengths.
 Standard coupling nut material is nickel plated brass.. "CKR(N)M.."; "CKR(N)MV.." indicates stainless steel coupling nut.

12 and 16-Pin Connectors, NAMUR Color Code

- For Eurofast® Junction Boxes and Multi-Conductor Applications
- IEC IP67 Protection



Connector Style	Male Part Number	Features	Pinout
<p>CSSNM ..</p> <p>Non-rotating coupling nut</p>	<p>CSSNM 12-9-* CSSNWM 12-9-*</p>	<p>ITC/PLTC PVC Blue, 9x22 AWG, 105 °C, 300 V, 3 A, 6.9 mm OD, Cable #RF50741-*M, 4 port, Namur, 1 isolated circuit per port or 2 circuits per port with common positive, Flexlife®</p>	<p>1. BN 2. WH 3. BK 4. GN 5. RD 6. OG 7. BU 8. YE 9. VT</p> <p>Male</p>
<p>CSSNWM ..</p> <p>Non-rotating coupling nut</p>	<p>CSSNM 16-16-* CSSNWM 16-16-*</p>	<p>ITC/PLTC PVC Blue, 16x22 AWG, 105 °C, 300 V, 3 A, 8.3 mm OD, Cable #RF50744-*M, 4 port, 2 isolated circuits per port, Flexlife</p>	<p>1. WH 2. BK 3. GN 4. RD 5. OG 6. BU 7. BN 8. YE 9. VT 10. GY 11. PK 12. TN 13. WH/BK 14. WH/GN 15. WH/RD 16. WH/BU</p> <p>Male</p>

We reserve the right to make technical alterations without prior notice.

Cordsets

* Length in meters.
Standard cable lengths are 5 and 10 meters. Consult factory for other lengths.
Standard coupling nut material is nickel plated brass.. "CSSNM..".

- Quick Push-Pull Connector
- For Eurofast® Junction Boxes and Multi-Conductor Applications
- IEC IP67 Protection



Connector Style	Female Part Number	Features	Pinout
	CKMH 12-11-*	ITC/PLTC PVC Yellow, 11x18 AWG, 105 °C, 300 V, 6 A, 10.5 mm OD, Cable #RF51088-*M, 8 port, 1 signal per port, Flexlife®	1. BN 2. N/C 3. BU 4. WH 5. GN 6. YE 7. GY 8. PK 9. RD 10. BK 11. VT 12. GN/YE
	CKMH 12-11-*/S90	AWM TPU Yellow, 11x18 AWG, 90 °C, 10 mm OD, Cable #RF50678-*M, 8 port, 1 signal per port, Cut/Abrasion Immune	
	CKMH 19-19-*	ITC/PLTC PVC Yellow, 3x18, 16x22 AWG, 105 °C, 10.0 mm OD, Cable #RF50620-*M, 8 port, 2 signals per port, Flexlife	1. VT 2. RD 3. GY 4. RD/BU 5. GN 6. BU 7. GY/PK 8. WH/GN 9. WH/YE 10. WH/GY 11. BK 12. GN/YE 13. YE/BN 14. BN/GN 15. WH 16. YE 17. PK 18. GY/BN 19. BN
	CKMH 19-19-*/S90	AWM TPU Yellow, 3x18, 16x22 AWG, 90 °C, 10.0 mm OD, Cable #RF50682-*M, 8 port, 2 signals per port Cut/Abrasion Immune	

We reserve the right to make technical alterations without prior notice.

* Length in meters.
 Standard cable lengths are 5 and 10 meters. Consult factory for other lengths.
 Standard coupling nut material is nickel plated brass..“CKMH..”.

26 and 28-Pin Cordsets

- For Multi-Conductor Applications
- IEC IP67 Protection
- 150 V, 3 A



We reserve the right to make technical alterations without prior notice.

Connector Style	Female Part Number	Male Part Number	Features	Pinout
<p>DKM ..</p> <p>DKWM ..</p>	<p>DKM 26-631-* DKWM 26-631-*</p>	<p>DSM 26-631-* DSWM 26-631-*</p>	<p>ITC/PLTC PVC Yellow, 25x22 AWG, 1x22 AWG drain, 105 °C, 10.0 mm OD, Cable #RF50631-[*]M, 25-wire DC applications, Flexlife®</p>	<p>Female</p> <p>1. BN 14. WH 2. WH/GY 15. BU 3. BU/GY 16. BK/GY 4. BN/GY 17. BN/OG 5. BK/YE 18. WH/OG 6. WH/YE 19. BK/OG 7. BU/YE 20. BK/GN 8. BN/YE 21. WH/GN 9. BK/RD 22. BU/GN 10. WH/RD 23. BN/GN 11. BU/RD 24. BU/OG 12. BN/RD 25. GN/YE 13. BK 26. N/C</p> <p>Male</p>
<p>DSM ..</p> <p>DSWM ..</p>	<p>DKM 28-061-* DKWM 28-061-*</p>	<p>DSM 28-061-* DSWM 28-061-*</p>	<p>ITC/PLTC PVC Yellow, 27x22 AWG, 1x22 AWG drain, 105 °C, 10.5 mm OD, Cable #RF51061-[*]M, 27-wire DC applications, Flexlife</p>	<p>Female</p> <p>1. BN 15. BU 2. WH/GY 16. BK/GY 3. BU/GY 17. BN/OG 4. BN/GY 18. WH/OG 5. BK/YE 19. BK/OG 6. WH/YE 20. BK/GN 7. BU/YE 21. WH/GN 8. BN/YE 22. BU/GN 9. BK/RD 23. BN/GN 10. WH/RD 24. BU/OG 11. BU/RD 25. GN/YE 12. BN/RD 26. GY 13. BK 27. OG 14. WH 28. N/C</p> <p>Male</p>

* Length in meters.
Standard cable lengths are 5 and 10 meters. Consult factory for other lengths.
Standard coupling nut material is nickel plated brass.. "DKM.." / "DKWM..".

Cordsets

26 and 28-Pin Cordsets

- For Multi-Conductor Applications
- IEC IP67 Protection
- 150 V, 5 A





Connector Style	Male Part Number	Features	Pinout																												
<p>DSSM ..</p> <p>Non-rotating coupling nut</p>	<p>DSSM 26-631-* DSSWM 26-631-*</p>	<p>ITC/PLTC PVC Yellow, 25x22 AWG, 1x22 AWG drain, 105 °C, 10.0 mm OD, Cable #RF50631-*M, 25-wire DC applications, Flexlife®</p>	<table border="0"> <tr><td>1. BN</td><td>14. WH</td></tr> <tr><td>2. WH/GY</td><td>15. BU</td></tr> <tr><td>3. BU/GY</td><td>16. BK/GY</td></tr> <tr><td>4. BN/GY</td><td>17. BN/OG</td></tr> <tr><td>5. BK/YE</td><td>18. WH/OG</td></tr> <tr><td>6. WH/YE</td><td>19. BK/OG</td></tr> <tr><td>7. BU/YE</td><td>20. BK/GN</td></tr> <tr><td>8. BN/YE</td><td>21. WH/GN</td></tr> <tr><td>9. BK/RD</td><td>22. BU/GN</td></tr> <tr><td>10. WH/RD</td><td>23. BN/GN</td></tr> <tr><td>11. BU/RD</td><td>24. BU/OG</td></tr> <tr><td>12. BN/RD</td><td>25. GN/YE</td></tr> <tr><td>13. BK</td><td>26. N/C</td></tr> </table> <p>Male</p>	1. BN	14. WH	2. WH/GY	15. BU	3. BU/GY	16. BK/GY	4. BN/GY	17. BN/OG	5. BK/YE	18. WH/OG	6. WH/YE	19. BK/OG	7. BU/YE	20. BK/GN	8. BN/YE	21. WH/GN	9. BK/RD	22. BU/GN	10. WH/RD	23. BN/GN	11. BU/RD	24. BU/OG	12. BN/RD	25. GN/YE	13. BK	26. N/C		
1. BN	14. WH																														
2. WH/GY	15. BU																														
3. BU/GY	16. BK/GY																														
4. BN/GY	17. BN/OG																														
5. BK/YE	18. WH/OG																														
6. WH/YE	19. BK/OG																														
7. BU/YE	20. BK/GN																														
8. BN/YE	21. WH/GN																														
9. BK/RD	22. BU/GN																														
10. WH/RD	23. BN/GN																														
11. BU/RD	24. BU/OG																														
12. BN/RD	25. GN/YE																														
13. BK	26. N/C																														
<p>DSSWM ..</p> <p>Non-rotating coupling nut</p>	<p>DSSM 28-061-* DSSWM 28-061-*</p>	<p>ITC/PLTC PVC Yellow, 27x22 AWG, 1x22 AWG drain, 105 °C, 10.5 mm OD, Cable #RF51061-*M, 27-wire DC applications, Flexlife</p>	<table border="0"> <tr><td>1. BN</td><td>15. BU</td></tr> <tr><td>2. WH/GY</td><td>16. BK/GY</td></tr> <tr><td>3. BU/GY</td><td>17. BN/OG</td></tr> <tr><td>4. BN/GY</td><td>18. WH/OG</td></tr> <tr><td>5. BK/YE</td><td>19. BK/OG</td></tr> <tr><td>6. WH/YE</td><td>20. BK/GN</td></tr> <tr><td>7. BU/YE</td><td>21. WH/GN</td></tr> <tr><td>8. BN/YE</td><td>22. BU/GN</td></tr> <tr><td>9. BK/RD</td><td>23. BN/GN</td></tr> <tr><td>10. WH/RD</td><td>24. BU/OG</td></tr> <tr><td>11. BU/RD</td><td>25. GN/YE</td></tr> <tr><td>12. BN/RD</td><td>26. GY</td></tr> <tr><td>13. BK</td><td>27. OG</td></tr> <tr><td>14. WH</td><td>28. N/C</td></tr> </table> <p>Male</p>	1. BN	15. BU	2. WH/GY	16. BK/GY	3. BU/GY	17. BN/OG	4. BN/GY	18. WH/OG	5. BK/YE	19. BK/OG	6. WH/YE	20. BK/GN	7. BU/YE	21. WH/GN	8. BN/YE	22. BU/GN	9. BK/RD	23. BN/GN	10. WH/RD	24. BU/OG	11. BU/RD	25. GN/YE	12. BN/RD	26. GY	13. BK	27. OG	14. WH	28. N/C
1. BN	15. BU																														
2. WH/GY	16. BK/GY																														
3. BU/GY	17. BN/OG																														
4. BN/GY	18. WH/OG																														
5. BK/YE	19. BK/OG																														
6. WH/YE	20. BK/GN																														
7. BU/YE	21. WH/GN																														
8. BN/YE	22. BU/GN																														
9. BK/RD	23. BN/GN																														
10. WH/RD	24. BU/OG																														
11. BU/RD	25. GN/YE																														
12. BN/RD	26. GY																														
13. BK	27. OG																														
14. WH	28. N/C																														

We reserve the right to make technical alterations without prior notice.

* Length in meters.
Standard cable lengths are 5 and 10 meters. Consult factory for other lengths.
Standard coupling material is nickel plated brass. "DSSM.." / "DSSWM..".

Receptacle Selection Guide

Mounting Style	Image	Panel Thread Types	Page
<p>Front Mount</p>		<p><u>M23</u> <u>H20</u></p> <hr/> <p><u>M27</u> <u>H30</u></p>	
<p>Rear Mount</p>		<p><u>M23</u> <u>H25</u></p>	

We reserve the right to make technical alterations without prior notice.

Cordsets

12-Pin Receptacles, Front Mount

- For use with Junction Box Home Run Cables
- IEC IP67 Protection
- 300 V, 6 A

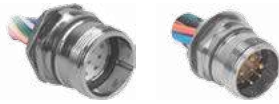

Connector Style	Female Part Number	Male Part Number	Features	Pinout	
	CKF 12-7-*	CSF 12-7-*	Nickel plated brass, 7x18 AWG, 105 °C, 4-port, 1 signal per port	1. BN 3. BU 4. WH 6. GN	7. YE 8. GY 12. GN/YE
<p>CS(K)F..</p> <p>Typical panel cutout is 20.4 x 19 x 20.4 mm</p>	CKF 12-9-*	CKF 12-9-*	Nickel plated brass, 9x18 AWG, 105 °C, 6-port, 1 signal per port	1. BN 3. BU 4. WH 6. GN 7. YE	8. GY 9. PK 10. RD 12. GN/YE
	CKF 12-11-*	CSF 12-11-*	Nickel plated brass, 11x18 AWG, 105 °C, 8-port, 1 signal per port	1. BN 3. BU 4. WH 5. GN 6. YE 7. GY	8. PK 9. RD 10. BK 11. VT 12. GN/YE
<p>CS(K)FL..</p> <p>Typical panel cutout is 20.4 x 19 x 20.4 mm</p>	CKF 12-12-*	CSF 12-12-*	Nickel plated brass, 12x18 AWG, 105 °C, 8-port, 1 signal per port	1. BN 2. OG 3. BU 4. WH 5. GN 6. YE	7. GY 8. PK 9. RD 10. BK 11. VT 12. GN/YE
	CKF 12-12-*/S817	CSF 12-12-*/S817	Nickel plated brass, 12x18 AWG, 105 °C, 8-port, 1 signal per port	1. BN 2. BU 3. WH 4. GN/YE 5. OG 6. YE	7. GY 8. PK 9. RD 10. BN/WH 11. BU/WH 12. GN/WH

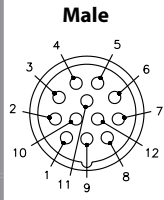
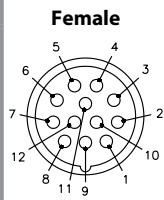

We reserve the right to make technical alterations without prior notice.

* Length in meters. Standard lead length is 1 meter. Consult factory for other lengths.
 "CSFL .." indicates long mounting threads; "CSFLV .." indicates stainless steel housing with long threads.
 To specify PVC jacketed cable, add "/S717" to the end of the part number.

19-Pin Receptacles, Front Mount

- For use with Junction Box Home Run Cables
- IEC IP67 Protection
- 150 V, 9 A (pins 6, 12, 19), all others 2 A



We reserve the right to make technical alterations without prior notice.

Connector Style	Female Part Number	Male Part Number	Features	Pinout
<p>CS(K)F..</p> <p>Typical panel cutout is 20.4 x 19 x 20.4 mm</p>	CKF 19-11-*	CSF 19-11-*	Nickel plated brass, 3x18, 8x22 AWG, 105 °C, 4-port, 2 signals per port	3. GY 4. RD/BU 5. GN 6. BU 7. GY/PK 8. WH/GN 12. GN/YE 14. BN/GN 15. WH 16. YE 19. BN
	CKF 19-15-*	CSF 19-15-*	Nickel plated brass, 3x18, 12x22 AWG, 105 °C, 6-port, 2 signals per port	<p>Female</p> 2. RD 3. GY 4. RD/BU 5. GN 6. BU 7. GY/PK 8. WH/GN 9. WH/YE 12. GN/YE 14. BN/GN 15. WH 16. YE 17. PK 19. BN
	CKF 19-19-*	CSF 19-19-*	Nickel plated brass, 3x18, 16x22 AWG, 105 °C, 8-port, 2 signals per port	<p>Male</p> 1. VT 2. RD 3. GY 4. RD/BU 5. GN 6. BU 7. GY/PK 8. WH/GN 9. WH/YE 10. WH/GY 11. BK 12. GN/YE 13. YE/BN 14. BN/GN 15. WH 16. YE 17. PK 18. GY/BN 19. BN

* Length in meters. Standard lead length is 1 meter. Consult factory for other lengths.
 "CSFL..." indicates long mounting threads; "CSFLV..." indicates stainless steel housing with long threads.
 To specify PVC jacketed cable, add "/S717" to the end of the part number.

Receptacles

12 and 16-Pin Receptacles, Front Mount

- For use with Junction Box Home Run Cables
- IEC IP67 Protection



Connector Style	Female Part Number	Male Part Number	Features	Pinout														
<p>CK(A)(B)F.. CS(A)(B)F..</p> <p>Typical panel cutout is 20.4 x 19 x 20.4 mm</p>	CKAF 16-10-*	CSAF 16-10-*	Nickel plated brass, 10x18 AWG, 105 °C, 150 V, 6 A, 4-port, Isolated Power Supply	<table border="0"> <tr> <td>1. BN</td> <td>7. YE</td> </tr> <tr> <td>3. BU</td> <td>8. GY</td> </tr> <tr> <td>4. WH</td> <td>11. BN/WH</td> </tr> <tr> <td>5. GN/YE</td> <td>13. BU/WH</td> </tr> <tr> <td>6. OG</td> <td>15. GN/WH</td> </tr> </table>	1. BN	7. YE	3. BU	8. GY	4. WH	11. BN/WH	5. GN/YE	13. BU/WH	6. OG	15. GN/WH				
	1. BN	7. YE																
3. BU	8. GY																	
4. WH	11. BN/WH																	
5. GN/YE	13. BU/WH																	
6. OG	15. GN/WH																	
CKAF 16-12-*	CSAF 16-12-*	Nickel plated brass, 12x18 AWG, 105 °C, 150 V, 6 A, 6-port, Isolated Power Supply	<table border="0"> <tr> <td>1. BN</td> <td>8. GY</td> </tr> <tr> <td>3. BU</td> <td>9. PK</td> </tr> <tr> <td>4. WH</td> <td>10. RD</td> </tr> <tr> <td>5. GN/YE</td> <td>11. BN/WH</td> </tr> <tr> <td>6. OG</td> <td>13. BU/WH</td> </tr> <tr> <td>7. YE</td> <td>15. GN/WH</td> </tr> </table>	1. BN	8. GY	3. BU	9. PK	4. WH	10. RD	5. GN/YE	11. BN/WH	6. OG	13. BU/WH	7. YE	15. GN/WH			
1. BN	8. GY																	
3. BU	9. PK																	
4. WH	10. RD																	
5. GN/YE	11. BN/WH																	
6. OG	13. BU/WH																	
7. YE	15. GN/WH																	
<p>CK(A)(B)FL.. CS(A)(B)FL..</p> <p>Typical panel cutout is 20.4 x 19 x 20.4 mm</p>	CKAF 16-14-*	CSAF 16-14-*	Nickel plated brass, 14x18 AWG, 105 °C, 150 V, 6 A, 8-port, Isolated Power Supply	<table border="0"> <tr> <td>1. BN</td> <td>9. PK</td> </tr> <tr> <td>3. BU</td> <td>10. RD</td> </tr> <tr> <td>4. WH</td> <td>11. BN/WH</td> </tr> <tr> <td>5. GN/YE</td> <td>12. BK</td> </tr> <tr> <td>6. OG</td> <td>13. BU/WH</td> </tr> <tr> <td>7. YE</td> <td>14. VT</td> </tr> <tr> <td>8. GY</td> <td>15. GN/WH</td> </tr> </table>	1. BN	9. PK	3. BU	10. RD	4. WH	11. BN/WH	5. GN/YE	12. BK	6. OG	13. BU/WH	7. YE	14. VT	8. GY	15. GN/WH
	1. BN	9. PK																
3. BU	10. RD																	
4. WH	11. BN/WH																	
5. GN/YE	12. BK																	
6. OG	13. BU/WH																	
7. YE	14. VT																	
8. GY	15. GN/WH																	
CKBF 12-7-*	CSBF 12-7-*	Nickel plated brass, 7x18 AWG, 105 °C, 300 V, 6 A, 4-port, with LEDs	<table border="0"> <tr> <td>1. WH/BK</td> <td>5. OG</td> </tr> <tr> <td>2. BK</td> <td>6. BU</td> </tr> <tr> <td>3. WH</td> <td>7. GN</td> </tr> <tr> <td>4. RD</td> <td></td> </tr> </table>	1. WH/BK	5. OG	2. BK	6. BU	3. WH	7. GN	4. RD								
1. WH/BK	5. OG																	
2. BK	6. BU																	
3. WH	7. GN																	
4. RD																		
CKBF 12-11-*	CSBF 12-11-*	Nickel plated brass, 11x18 AWG, 105 °C, 300 V, 6 A, 8-port, with LEDs	<table border="0"> <tr> <td>1. OG</td> <td>7. BU/BK</td> </tr> <tr> <td>2. BU</td> <td>9. GN</td> </tr> <tr> <td>3. WH/BK</td> <td>10. RD</td> </tr> <tr> <td>4. RD/BK</td> <td>11. WH</td> </tr> <tr> <td>5. GN/BK</td> <td>12. BK</td> </tr> <tr> <td>6. OG/BK</td> <td></td> </tr> </table>	1. OG	7. BU/BK	2. BU	9. GN	3. WH/BK	10. RD	4. RD/BK	11. WH	5. GN/BK	12. BK	6. OG/BK				
1. OG	7. BU/BK																	
2. BU	9. GN																	
3. WH/BK	10. RD																	
4. RD/BK	11. WH																	
5. GN/BK	12. BK																	
6. OG/BK																		

We reserve the right to make technical alterations without prior notice.

* Length in meters. Standard lead length is 1 meter. Consult factory for other lengths.
 "CSA(B)FL .." indicates long mounting threads; "CSA(B)FLV .." indicates stainless steel housing with long threads.
 To specify PVC jacketed cable, add "/S717" to the end of the part number.

12-Pin Receptacles, Front Mount

- For use with Junction Box Home Run Cables
- IEC IP67 Protection
- 300 V, 6 A

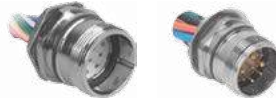

Connector Style	Female Part Number	Male Part Number	Features	Pinout
<p>CK(C)(N)F.. CS(C)(N)F..</p> <p>Typical panel cutout is 20.4 x 19 x 20.4 mm</p>	CKCF 12-7-*	CSCF 12-7-*	Nickel plated brass, 7x18 AWG, 105 °C, 4-port, 1 signal per port, 4MB12Z-4-*	<p>Female</p>
<p>CK(C)(N)FL.. CS(C)(N)FL..</p> <p>Typical panel cutout is 20.4 x 19 x 20.4 mm</p>	CKCF 12-11-*	CSCF 12-11-*	Nickel plated brass, 11x18 AWG, 105 °C, 8-port, 1 signal per port, 8MB12Z-4-*	<p>Female</p>
<p>CKNF 12-9-*</p> <p>Typical panel cutout is 20.4 x 19 x 20.4 mm</p>	CKNF 12-9-*	CSNF 12-9-*	Nickel plated brass, 9x18 AWG, 105 °C, 4-port, 1 isolated circuit per port or 2 circuits per port with common positive	<p>Male</p>

We reserve the right to make technical alterations without prior notice.

Receptacles

* Length in meters. Standard lead length is 1 meter. Consult factory for other lengths.
 "CSC(N or R)FL .." indicates long mounting threads; "CSC(N or R)FLV .." indicates stainless steel housing with long threads.
 To specify PVC jacketed cable, add "/S717" to the end of the part number.

- For use with Junction Box Home Run Cables
- IEC IP67 Protection



Connector Style	Female Part Number	Male Part Number	Features	Pinout
<p>CK(C)(N)(R)F.. CS(C)(N)(R)F..</p> <p>Typical panel cutout is 20.4 x 19 x 20.4 mm</p>	CKNF 16-16-*	CSNF 16-16-*	Nickel plated brass, 16x22 AWG, 105 °C, 300 V, 3 A, 4-port, 2 isolated circuits per port	<p>Female</p> <p>Male</p>
<p>CK(C)(N)(R)FL.. CS(C)(N)(R)FL..</p> <p>Typical panel cutout is 20.4 x 19 x 20.4 mm</p>	CKRF 12-6-*	CSRF 12-6-*	Nickel plated brass, 6x18 AWG, 105 °C, 300 V, 6 A, 4-port, No LEDs	<p>Female</p>
	CKRF 12-8-*	CSRF 12-8-*	Nickel plated brass, 8x18 AWG, 105 °C, 300 V, 6 A, 6-port, No LEDs	
	CKRF 12-10-*	CSRF 12-10-*	Nickel plated brass, 10x18 AWG, 105 °C, 300 V, 6 A, 8-port, No LEDs	<p>Male</p>

We reserve the right to make technical alterations without prior notice.

* Length in meters. Standard lead length is 1 meter. Consult factory for other lengths.
 "CSC(N or R)FL .." indicates long mounting threads; "CSC(N or R)FLV .." indicates stainless steel housing with long threads.
 To specify PVC jacketed cable, add "/S717" to the end of the part number.

12-Pin Receptacles, Rear Mount

- For use with Junction Box Home Run Cables
- IEC IP67 Protection
- 300 V, 6 A



Connector Style	Female Part Number	Male Part Number	Features	Pinout
<p>CS(K)FD..</p> <p>Typical panel cutout is 25.4 x 24.3 x 25.4 mm</p>	CKFD 12-7-*	CSFD 12-7-*	Nickel plated brass, 7x18 AWG, 105 °C, 4-port, 1 signal per port	1. BN 3. BU 4. WH 6. GN 7. YE 8. GY 12. GN/YE
	CKFD 12-9-*	CSFD 12-9-*	Nickel plated brass, 9x18 AWG, 105 °C, 6-port, 1 signal per port	Female 1. BN 3. BU 4. WH 6. GN 7. YE 8. GY 9. PK 10. RD 12. GN/YE
	CKFD 12-11-*	CSFD 12-11-*	Nickel plated brass, 11x18 AWG, 105 °C, 8-port, 1 signal per port	1. BN 3. BU 4. WH 5. GN 6. YE 7. GY 8. PK 9. RD 10. BK 11. VT 12. GN/YE
	CKFD 12-12-*	CSFD 12-12-*	Nickel plated brass, 12x18 AWG, 105 °C, 8-port, 1 signal per port	1. BN 2. OG 3. BU 4. WH 5. GN 6. YE 7. GY 8. PK 9. RD 10. BK 11. VT 12. GN/YE
	CKFD 12-12-*/S817	CSFD 12-12-*/S817	Nickel plated brass, 12x18 AWG, 105 °C, 8-port, 1 signal per port	Male 1. BN 2. BU 3. WH 4. GN/YE 5. OG 6. YE 7. GY 8. PK 9. RD 10. BN/WH 11. BU/WH 12. GN/WH

We reserve the right to make technical alterations without prior notice.

Receptacles

* Length in meters. Standard lead length is 1 meter. Consult factory for other lengths. To specify PVC jacketed cable, add "/S717" to the end of the part number.

19-Pin Receptacles, Rear Mount

- For use with Junction Box Home Run Cables
- IEC IP67 Protection
- 150 V, 9 A (pins 6, 12, 19), All others 2 A



Connector Style	Female Part Number	Male Part Number	Features	Pinout
<p>CS(K)FD..</p> <p>Typical panel cutout is 25.4 x 24.3 x 25.4 mm</p>	CKFD 19-11-*	CSFD 19-11-*	Nickel plated brass, 3x18, 8x22 AWG, 105 °C, 4-port, 2 signals per port	<p>3. GY 4. RD/BU 5. GN 6. BU 7. GY/PK 8. WH/GN 12. GN/YE 14. BN/GN 15. WH 16. YE 19. BN</p> <p>Female</p>
	CKFD 19-15-*	CSFD 19-15-*	Nickel plated brass, 3x18, 12x22 AWG, 105 °C, 6-port, 2 signals per port	<p>2. RD 3. GY 4. RD/BU 5. GN 6. BU 7. GY/PK 8. WH/GN 9. WH/YE 12. GN/YE 13. YE/BN 14. BN/GN 15. WH 16. YE 17. PK 19. BN</p>
	CKFD 19-19-*	CSFD 19-19-*	Nickel plated brass, 3x18, 16x22 AWG, 105 °C, 8-port, 2 signals per port	<p>1. VT 2. RD 3. GY 4. RD/BU 5. GN 6. BU 7. GY/PK 8. WH/GN 9. WH/YE 10. WH/GY 11. BK 12. GN/YE 13. YE/BN 14. BN/GN 15. WH 16. YE 17. PK 18. GY/BN 19. BN</p> <p>Male</p>

We reserve the right to make technical alterations without prior notice.

* Length in meters. Standard lead length is 1 meter. Consult factory for other lengths. To specify PVC jacketed cable, add "/S717" to the end of the part number.

16-Pin Receptacles, Rear Mount

- For use with Junction Box Home Run Cables
- IEC IP67 Protection
- 150 V, 6 A



Connector Style	Female Part Number	Male Part Number	Features	Pinout
<p>CS(K)FD..</p> <p>Typical panel cutout is 25.4 x 24.3 x 25.4 mm</p>	CKAFD 16-10-*	CSAFD 16-10-*	Nickel plated brass, 10x18 AWG, 105 °C, 4-port, Isolated Power Supply	<p>1. BN 3. BU 4. WH 5. GN/YE 6. OG 7. YE 8. GY 11. BN/WH 13. BU/WH 15. GN/WH</p> <p>Female</p>
	CKAFD 16-12-*	CSAFD 16-12-*	Nickel plated brass 12x18 AWG, 105 °C, 6-port, Isolated Power Supply	<p>1. BN 3. BU 4. WH 5. GN/YE 6. OG 7. YE 8. GY 9. PK 10. RD 11. BN/WH 13. BU/WH 15. GN/WH</p>
	CKAFD 16-14-*	CSAFD 16-14-*	Nickel plated brass, 14x18 AWG, 105 °C, 8-port, Isolated Power Supply	<p>1. BN 3. BU 4. WH 5. GN/YE 6. OG 7. YE 8. GY 9. PK 10. RD 11. BN/WH 12. BK 13. BU/WH 14. VT 15. GN/WH</p> <p>Male</p>

We reserve the right to make technical alterations without prior notice.

Receptacles

* Length in meters. Standard lead length is 1 meter. Consult factory for other lengths.
To specify PVC jacketed cable, add "/S717" to the end of the part number.

12-Pin Receptacles, Rear Mount

- For use with Junction Box Home Run Cables
- IEC IP67 Protection
- 300 V, 6 A



Connector Style	Female Part Number	Male Part Number	Features	Pinout
<p>CS(K)FD..</p> <p>Typical panel cutout is 25.4 x 24.3 x 25.4 mm</p>	CKBFD 12-7-*	CSBFD 12-7-*	Nickel plated brass, 7x18 AWG, 105 °C, 4-port, with LEDs	1. WH/BK 2. BK 3. WH 4. RD 5. OG 6. BU 7. GN
	CKBFD 12-11-*	CSBFD 12-11-*	Nickel plated brass, 11x18 AWG, 105 °C, 8-port, with LEDs	1. OG 2. BU 3. WH/BK 4. RD/BK 5. GN/BK 6. OG/BK 7. BU/BK 9. GN 10. RD 11. WH 12. BK
	CKCFD 12-7-*	CSCFD 12-7-*	Nickel plated brass, 7x18 AWG, 105 °C, 4-port, 1 signal per port, 4MB12Z-4-*	1. WH 2. GN 3. YE 4. GY 10. BU 11. BN 12. GN/YE
	CKCFD 12-9-*	CSCFD 12-9-*	Nickel plated brass, 9x18 AWG, 105 °C, 4-port, 1 signal per port, 6MB12Z-4-*	1. WH 2. GN 3. YE 4. GY 5. PK 6. RD 10. BU 11. BN 12. GN/YE
	CKCFD 12-11-*	CSCFD 12-11-*	Nickel plated brass, 11x18 AWG, 105 °C, 8-port, 1 signal per port, 8MB12Z-4-*	1. WH 2. GN 3. YE 4. GY 5. PK 6. RD 7. BK 8. VT 10. BU 11. BN 12. GN/YE

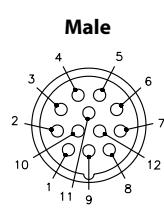
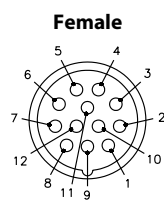

We reserve the right to make technical alterations without prior notice.

* Length in meters. Standard lead length is 1 meter. Consult factory for other lengths. To specify PVC jacketed cable, add "/S717" to the end of the part number.

12 and 16-Pin Receptacles, Rear Mount

- For use with Junction Box Home Run Cables
- IEC IP67 Protection



We reserve the right to make technical alterations without prior notice.

Receptacles

Connector Style	Female Part Number	Male Part Number	Features	Pinout
<p>CS(K)FD..</p> <p>Typical panel cutout is 25.4 x 24.3 x 25.4 mm</p>	CKNFD 12-9-*	CSNFD 12-9-*	Nickel plated brass, 9x22 AWG, 105 °C, 300 V, 6 A, 4-port, 1 Isolated Circuits Per Port, 2 Circuits Per Port, with Common Positive	<p>Female</p> <p>1. BN 2. WH 3. BK 4. GN 5. RD 6. OG 7. BU 8. YE 9. VT</p> <p>Male</p>
	CKNFD 16-16-*	CSNFD 16-16-*	Nickel plated brass, 16x22 AWG, 105 °C, 300 V, 3 A, 4-port, 2 Isolated Circuits Per Port	<p>Female</p> <p>1. WH 2. BK 3. GN 4. RD 5. OG 6. BU 7. BN 8. YE 9. VT 10. GY 11. PK 12. Tn 13. WH/BK 14. WH/GN 15. WH/RD 16. WH/BU</p> <p>Male</p>
	CKRFD 12-6-*	CSRFD 12-6-*	Nickel plated brass, 6x18 AWG, 105 °C, 300 V, 6 A, 4-port, No LEDs	<p>Female</p>
	CKRFD 12-8-*	CSRFD 12-8-*	Nickel plated brass, 8x18 AWG, 105 °C, 300 V, 6 A, 6-port, No LEDs	<p>Female</p> <p>1. OG 5. WH 2. BU 6. RD 3. YE 7. GN 4. BK 8. BN</p>
	CKRFD 12-10-*	CSRFD 12-10-*	Nickel plated brass, 10x18 AWG, 105 °C, 300 V, 6 A, 8-port, No LEDs	<p>Male</p> <p>1. VT 2. BU 3. GY 4. BK 5. WH 6. RD 7. GN 8. YE 9. OG 10. BN</p>

26 and 28-Pin Receptacles, Front Mount

- For use with Junction Box Home Run Cables
- IEC IP67 Protection
- 150 V, 3 A



Connector Style	Female Part Number	Male Part Number	Features	Pinout
<p>DS(K)F..</p> <p>Typical panel cutout is 28.3 mm</p>	DKF 26-25-*	DSF 26-25-*	Nickel-plated brass, 25x22 AWG, 105 °C, 25-wire applications	<p>1. BN</p> <p>2. WH/GY</p> <p>3. BU/GY</p> <p>4. BN/GY</p> <p>5. BK/YE</p> <p>6. WH/YE</p> <p>7. BU/YE</p> <p>8. BN/YE</p> <p>9. BK/RD</p> <p>10. WH/RD</p> <p>11. BU/RD</p> <p>12. BN/RD</p> <p>13. BK</p> <p>14. WH</p> <p>15. BU</p> <p>16. BK/GY</p> <p>17. BN/OG</p> <p>18. WH/OG</p> <p>19. BK/OG</p> <p>20. BK/GN</p> <p>21. WH/GN</p> <p>22. BU/GN</p> <p>23. BN/GN</p> <p>24. BU/OG</p> <p>25. GN/YE</p> <p>26. N/C</p> <p>Female</p> <p>Male</p>
	DKF 28-27-*	DSF 28-27-*	Nickel-plated brass, 27x22 AWG, 105 °C, 27-wire applications	<p>1. BN</p> <p>2. WH/GY</p> <p>3. BU/GY</p> <p>4. BN/GY</p> <p>5. BK/YE</p> <p>6. WH/YE</p> <p>7. BU/YE</p> <p>8. BN/YE</p> <p>9. BK/RD</p> <p>10. WH/RD</p> <p>11. BU/RD</p> <p>12. BN/RD</p> <p>13. BK</p> <p>14. WH</p> <p>15. BU</p> <p>16. BK/GY</p> <p>17. BN/OG</p> <p>18. WH/OG</p> <p>19. BK/OG</p> <p>20. BK/GN</p> <p>21. WH/GN</p> <p>22. BU/GN</p> <p>23. BN/GN</p> <p>24. BU/OG</p> <p>25. GN/YE</p> <p>26. GY</p> <p>27. OG</p> <p>28. N/C</p> <p>Female</p> <p>Male</p>

We reserve the right to make technical alterations without prior notice.

* Length in meters. Standard lead length is 1 meter. Consult factory for other lengths. To specify PVC jacketed cable, add "/S717" to the end of the part number.

12, 16 and 19-Pin Field Wireable In-line Connectors

- For use with Custom Wiring & Junction Boxes
- Convert Hard Wiring into Quick Disconnect
- IEC IP65 Protection



Connector Style	Female Part Number	Features	Pinout
	CK 12-0	Nickel plated brass, PG 11 cable gland, accepts 4-10 mm cable diameter, accepts up to 12x18 AWG conductors, 125 °C, 300 V, 8.0 A, field wireable 12-pin in-line connector, for use with Minifast®, Eurofast® (single input per port) and Microfast® junctions boxes	<p>Female</p>
	CK 16-0	Nickel plated brass, PG 13.5 cable gland, accepts 5-12 mm cable diameter, accepts up to 16x18 AWG conductors, 125 °C, 150 V, 8.0 A, field wireable 16-pin in-line connector, for use with Eurofast (isolated power supply) junctions boxes	<p>Female</p>
	CK 19-0	Nickel plated brass, PG 13.5 cable gland, accepts 5-12 mm cable diameter, accepts up to 19x18 AWG conductors, 125 °C, 150 V, 8.0 A, field wireable 19-pin in-line connector, for use with Eurofast (two Signals per port) junctions boxes	<p>Female</p>
	CK 125-0	Nickel plated brass, IAC, accepts 3-10 mm cable diameter accepts up to 12x18 AWG conductors, 125 °C, 150 V, 8.0 A, field wireable 12-pin in-line connector	<p>Female</p>

We reserve the right to make technical alterations without prior notice.

Field Wireable

12, 16 and 19-Pin Field Wireable In-line Connectors

- For use with Custom Wiring & Junction Boxes
- Convert Hard Wiring into Quick Disconnect
- IEC IP65 Protection



Connector Style	Male Part Number	Features	Pinout
 	<p>CSS 12-0</p>	<p>Nickel plated brass, PG 13.5 cable gland, accepts 5-12 mm cable diameter, accepts up to 12x18 AWG conductor, 125 °C, 300 V, 8.0 A, field wireable 12-pin in-line connector, for use with Minifast®, Eurofast® (single input per port) and Microfast® junctions boxes</p>	<p>Male</p>
	<p>CS 12-0</p>	<p>Nickel plated brass, PG 11 cable gland, accepts 4-10 mm cable diameter, accepts up to 12x18 AWG conductor, 125 °C, 300 V, 8.0 A, field wireable 12-pin in-line connector, for use with Minifast, Eurofast (single input per port) and Microfast junctions boxes</p>	
	<p>CSS 16-0 CS 16-0</p>	<p>Nickel plated brass, PG 13.5 cable gland, accepts 5-12 mm cable diameter, accepts up to 16x18 AWG conductor, 125 °C, 150 V, 8.0 A, field wireable 16-pin in-line connector, for use with Eurofast (isolated power supply) junctions boxes</p>	<p>Male</p>
	<p>CSS 19-0 CS 19-0</p>	<p>Nickel plated brass, PG 13.5 cable gland, accepts 5-12 mm cable diameter, accepts up to 19x18 AWG conductor, 125 °C, 150 V, 8.0 A, field wireable 19-pin in-line connector, for use with Eurofast (two signals per port) junctions boxes</p>	<p>Male</p>
	<p>CSS 125-0 CS 125-0</p>	<p>Nickel plated brass, IAC, accepts 3-10 mm cable diameter, accepts up to 12x18 AWG conductor, 125 °C, 150 V, 8.0 A, field wireable 12-pin in-line connector</p>	<p>Male</p>

We reserve the right to make technical alterations without prior notice.

12, 16 and 19-Pin Field Wireable, Front Mount

- For use with Custom Wiring & Junction Boxes
- Convert Hard Wiring into Quick Disconnect
- IEC IP65 Protection



Connector Style	Part Number	Features	Pinout
	<p>CKF 12-0 CKFL 12-0</p>	<p>Nickel plated brass, accepts up to 12x18 AWG conductor, 125 °C, 300 V, 8.0 A, field wireable 12-pin receptacle, for use with Minifast®, Eurofast® (single input per port) and Microfast® junctions boxes</p>	<p>Female</p>
	<p>CKF 16-0 CKFL 16-0</p>	<p>Nickel plated brass, accepts up to 16x18 AWG conductor, 125 °C, 150 V, 8.0 A, field wireable 16-pin receptacle, for use with Eurofast (isolated power supply) junctions boxes</p>	<p>Female</p>
	<p>CKF 19-0 CKFL 19-0</p>	<p>Nickel plated brass, accepts up to 19x18 AWG conductor, 125 °C, 150 V, 8.0 A, field wireable 19-pin receptacle, for use with Eurofast (two signals per port) junctions boxes</p>	<p>Female</p>
	<p>CSF 12-0 CSFL 12-0</p>	<p>Nickel plated brass, accepts up to 12x18 AWG conductor, 125 °C, 300 V, 8.0 A, field wireable 12-pin receptacle, for use with Minifast, Eurofast (single input per port) and Microfast junctions boxes</p>	<p>Male</p>
	<p>CSF 16-0 CSFL 16-0</p>	<p>Nickel plated brass, accepts up to 16x18 AWG conductor, 125 °C, 150 V, 8.0 A, field wireable 16-pin receptacle, for use with Eurofast (isolated power supply) junctions boxes</p>	<p>Male</p>
	<p>CSF 19-0 CSFL 19-0</p>	<p>Nickel plated brass, accepts up to 19x18 AWG conductor, 125 °C, 150 V, 8.0 A, field wireable 19-pin receptacle, for use with Eurofast (two signals per port) junctions boxes</p>	<p>Male</p>

We reserve the right to make technical alterations without prior notice.

Field Wireable

12, 16 and 19-Pin Field Wireable Receptacles, Rear Mount

- Convert Hard Wiring into Quick Disconnect
- For use with Custom Wiring
- IEC IP65 Protection



Connector Style	Part Number	Features	Pinout
	CKFD 12-0	Nickel plated brass, accepts up to 12x18 AWG conductor, 125 °C, 300 V, 8.0 A, field wireable 12-pin receptacle, for use with field wiring and custom panel wiring	<p>Female</p>
	CKFD 16-0	Nickel plated brass, accepts up to 16x18 AWG conductor, 125 °C, 150 V, 8.0 A, field wireable 16-pin receptacle, for use with field wiring and custom panel wiring	<p>Female</p>
	CKFD 19-0	Nickel plated brass, accepts up to 19x18 AWG conductor, 125 °C, 150 V, 8.0 A, field wireable 19-pin receptacle, for use with field wiring and custom panel wiring	<p>Female</p>
	CSFD 12-0	Nickel plated brass, accepts up to 12x18 AWG conductor, 125 °C, 300 V, 8.0 A, field wireable 12-pin receptacle, for use with field wiring and custom panel wiring	<p>Male</p>
	CSFD 16-0	Nickel plated brass, accepts up to 16x18 AWG conductor, 125 °C, 150 V, 8.0 A, field wireable 16-pin receptacle, for use with field wiring and custom panel wiring	<p>Male</p>

We reserve the right to make technical alterations without prior notice.

Conduit Adapters, 1 Port

- Attaches to Standard Crouse-Hinds 3/4" Form 8, Mark 9 Conduit Bodies for transition to 12 and 19-Pin Multifast Connectors
- Gasket and 8-32 x 1/2 Mounting Screws included
- IP67 Protection (only when all receptacles are mated or covered with plugs)
- Terminal Strips accept up to 14 AWG Wires



Housing Style	Part Number	Features	Wiring Diagram
	CA-1/CK 12	Nylon housing, nickel plated brass receptacle housing, 80 °C, 300 V, 4 A, attaches to standard conduit body for transition to 12-pin Multifast connector	
	CA-1/CKV 12	Nylon housing, stainless steel receptacle housing 80 °C, 300 V, 4 A, attaches to standard conduit body for transition to 12-pin Multifast connector	
	CA-1/CK 19	Nylon housing, nickel plated brass receptacle housing, 80 °C, 150 V, 4 A, attaches to standard conduit body for transition to 19-pin Multifast connector	
	CA-1/CKV 19	Nylon housing, stainless steel receptacle housing, 80 °C, 150 V, 4 A, attaches to standard conduit body for transition to 19-pin Multifast connector	

We reserve the right to make technical alterations without prior notice.

Adapters

Pinouts

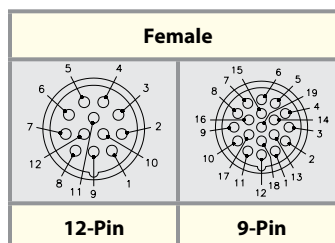

Accessories

- Field Wireable Assembly Tools
- Closure Caps

Housing Style	Part Number	Features
	CK-TOOL	Tool to aid assembly of all M23 Multifast field wireables with female threads
	CKF-TOOL	Tool to aid assembly of all M23 Multifast field wireables with male threads
	CS-CC	Nickel plated brass Neoprene gasket, closure caps for Multifast cordset connectors
	CK-CC	Nickel plated brass Neoprene gasket, closure caps for Multifast receptacles (CSF and CKF) and CSS cordset connectors

We reserve the right to make technical alterations without prior notice.

Part Number Keys	J3
Cordset and Receptacle Specifications	J4
Cordset and Receptacle Selection Matrix	J4
Cordset and Receptacle Dimensions	J5
Cordset and Receptacle Pinouts	J5
Closure Caps	J6
Powerlok and Disconnect Switch Accessories	J7

Features

- Ideal for small motor applications
- 3 and 4-pin
- 14 AWG conductors
- Up to 15 Amp, 600 Volt rated
- Dual rated TC-ER and STOOW PVC cable
- "/S4000" TC-ER only PVC cable option available
- NEMA 1, 3, 4, 6P protection
- IEC IP67 protection



Application Considerations

Installation Guidelines

Turck's Powerfast products are easy to install by following a few simple guidelines:

- It is important to know the electrical requirements of the application and to select a cordset that has the proper amperage and voltage ratings for the application.
- Cables must be supported to prevent movement on the equipment. Per NFPA 79, the cable must be supported every 12 inches in a non-vertical run, every 36 inches in a vertical run and every 18 inches when suspended in air. The cable should also be supported at any connection points or terminations.
- The cordsets are not intended for disconnection under load. Turck offers Powerlok fittings that prevent the possibility of disconnection. These fittings are not required for use, but can be used as a precautionary measure.
- Power should never be supplied from the male connector. The source of power should always be supplied from the female connector.
- Use Turck closure caps to protect connectors from damage or dirt when not connected.

Note: Consult NFPA 79 (Electrical Standard for Industrial Machinery) for required over current protection of conductors and other selection and installation guidelines for industrial machine applications.

Cable Options

Turck offers multiple cable options for the Powerfast products. The majority of Turck's Powerfast products use cables that carry a tray rated, exposed run (TC-ER) approval. Select Turck Powerfast products may carry an additional STOOW cable approval, although versions that carry the STOOW and TC-ER approval are also available as TC-ER only.

Both the STOOW/TC-ER cable and the TC-ER only cable version are premium cable offerings. However, the TC-ER only version has a slightly reduced cable outer diameter. This feature offers more flexibility and is a more cost effective solution. This cable option can be designated by adding a "/S4000" to the end of the part description where applicable.

We reserve the right to make technical alterations without prior notice.

Estimated hp ratings for D-Size Powerfast

(Based on 85% motor efficiency and 90% power factor.)

Single Phase (2 Current Carrying Conductors)				
Pin Count	AWG	Current (amps)	Voltage (volts)	Power (hp)
3-pin	10 AWG	30	230	7
			460	14
			575	17
	12 AWG	25	230	5
			460	11
			575	14
	14 AWG	18	230	4
			460	8
			575	10

Three Phase (3 Current Carrying Conductors)				
Pin Count	AWG	Current (amps)	Voltage (volts)	Power (hp)
4-pin	10 AWG	25	230	10
			460	20
			575	25
	12 AWG	20	230	8
			460	16
			575	20
	14 AWG	15	230	6
			460	12
			575	15

Note: These tables are theoretical values and are for reference only. Values will vary based on load conditions, as well as condition, age and type of motor. Please consult a qualified electrician for specific product sizing requirements. Current limits for conductor gauge size taken from NFPA 79 2007 edition.

2 and 3-Wire Receptacles, Front Mount, 1/4-18 NPT Threads

Part Number Keys are to assist in IDENTIFICATION ONLY. Consult factory for catalog items not identified.

M23 Multifast® Receptacle	R	K	M	34	-	*M	/S..
Gender	K = female connector, female threads S = male connector, male threads Y = male connector, female threads						
Coupling Nut Material	(blank) = nylon M = nickel plated brass V = 316 stainless steel (hex)						
Varieties							(blank) = TC-ER ST00W PVC cable jacket /S4000 = TC-ER PVC cable jacket /S.. = consult factory, special /CS.. = consult factory, special
Length in Meters							
Number of Wires / AWG / Color Codes							34 = 3x14 AWG GN, BK, WH 44 = 4x14 AWG BK, WH, RD, GN
Insertion Point of Extension Cable Second Prefix*							
* Male connector listed first, female connector second Example: RSM RKM 44-2M							

Extension Examples

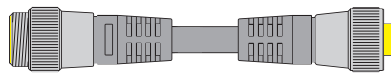

R S M **R K M** **44** - ***M**

A-Size 7/8" Powerfast Receptacle Part Number Key

A-Size 7/8" Powerfast Receptacle	R	K	F	V	34	-	*M	/NPT	/S..
Gender	K = female connector, female threads S = male connector, male threads X = female connector, male threads								
A-Size 7/8" Powerfast Receptacle									
Housing Material	(blank) = nickel plated brass K = nylon V = 316 stainless steel								
Varieties									/S.. = consult factory, special /CS.. = consult factory, special
Connection Thread									/NPT = 1/2-14 NPT threads /M20 = M20 x 1.5 threads
Length in Meters									
Number of Wires / AWG / Color Codes									34 = 3x14 AWG GN, BK, WH 44 = 4x14 AWG BK, WH, RD, GN

A-Size 7/8" Powerfast Cordset Specifications

Mechanical

Mold material/color:	PVC/Black
Contact carrier material:	PVC
Coupling nut material:	
Standard:	Nickel plated brass
Additional options:	Nylon 316 stainless steel
Environmental protection:	NEMA 1, 3, 4, 6P and IEC IP67
Temperature rating:	-40 °C to +90 °C (-40 °F to +194 °F)

Electrical

Contact material:	Brass or copper with gold plating
Cable jacket material/color:	
Standard:	TC-ER STOOW TPE/Black
Additional options:	TC-ER TPE or TC-ER PVC/Black (/S4000 version)
Ratings:	15 Amps, 600 VAC



A-Size 7/8" Powerfast Receptacle Part Number Key

Mechanical

Contact carrier material:	PVC
Housing material/plating:	
Standard:	Nickel plated brass
Additional options:	Nylon 316 stainless steel
Environmental protection:	NEMA 1, 3, 4, 6P and IEC IP67
Temperature rating:	-40 °C to +105 °C (-40 °F to +221 °F)

Electrical

Contact material:	Brass or copper with gold plating
Cable jacket material/color:	PVC
Ratings:	15 Amps, 600 VAC



A-Size 7/8" Powerfast Cordset Selection Matrix

			1	2	3	4
			Straight Female	Straight Male	Right Angle Female	Right Angle Male
Pins	AWG	Current Rating	TC-ER STOOW	TC-ER STOOW	TC-ER STOOW	TC-ER STOOW
3	14	15	RKM 34-*M	RSM 34-*M		
4	14	15	RKM 44-*M	RSM 44-*M		

Pins	AWG	Current Rating	TC-ER	TC-ER	TC-ER	TC-ER
3	14	15	RKM 34-*M/S4000	RSM 34-*M/S4000	WKM 34-*M/S4000	WSM 34-*M/S4000
4	14	15	RKM 44-*M/S4000	RSM 44-*M/S4000	WKM 44-*M/S4000	WSM 44-*M/S4000

A-Size 7/8" Powerfast Receptacle Selection Matrix

			5	6	7	8
			Female	Male	Female	Male
Pins	AWG	Current Rating	1/2-14 NPT Mounting Thread	1/2-14 NPT Mounting Thread	M20 Mounting Thread	M20 Mounting Thread
3	14	15	RKF 34-*M/NPT	RSF 34-*M/NPT	RSF 34-*M/M20	RKF 34-*M/M20
4	14	15	RKF 44-*M/NPT	RSF 44-*M/NPT	RSF 44-*M/M20	RKF 44-*M/M20

We reserve the right to make technical alterations without prior notice.

A-Size 7/8" Powerfast Cordset and Receptacle Dimensions

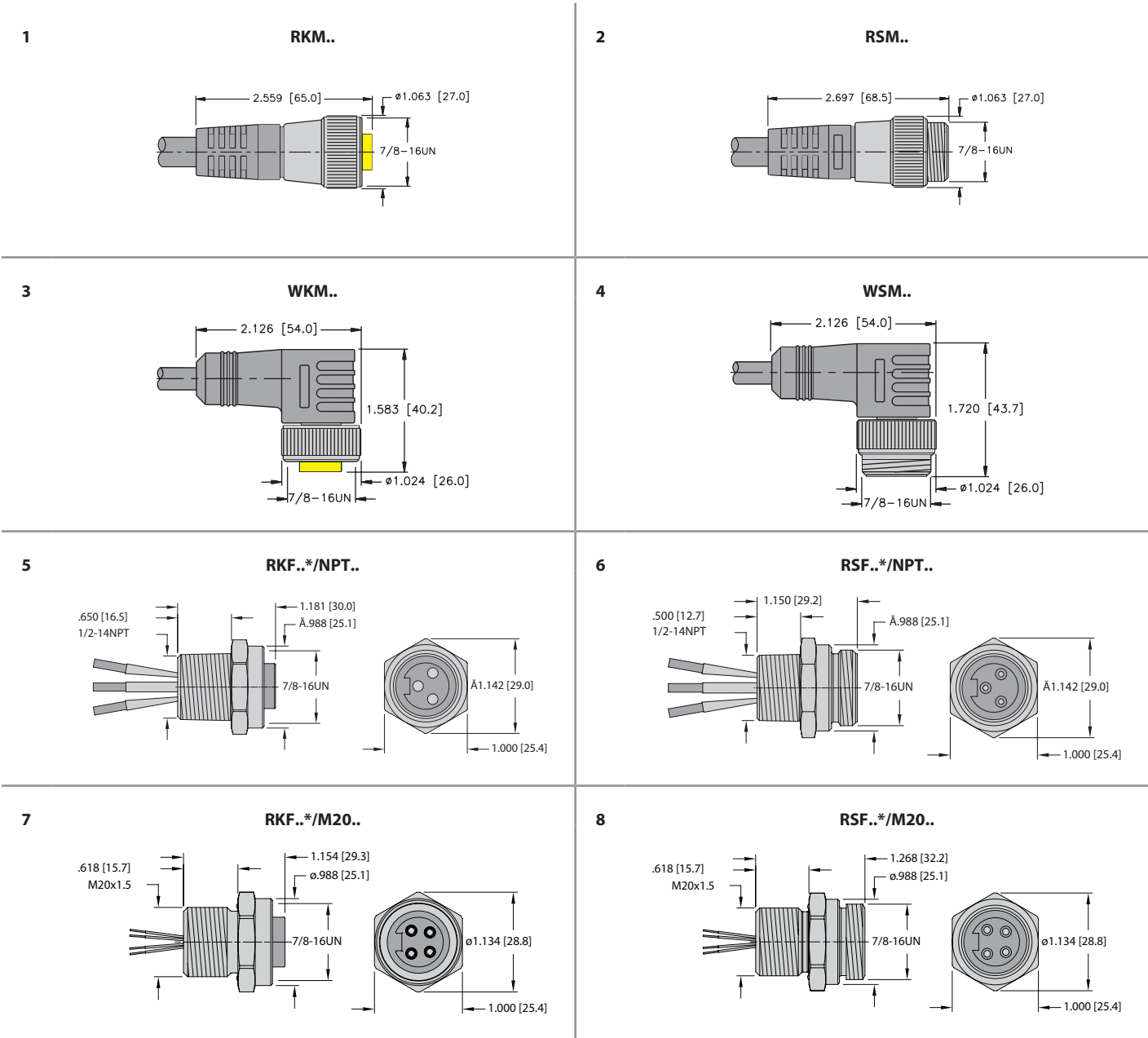

A-Size 7/8" powerfast

A-Size 7/8" Powerfast Cordset and Receptacle Pinouts

3-Pin		Pinouts	4-Pin		Pinouts
Female	Male		Female	Male	
		1. GN 2. BK 3. WH			1. BK 2. WH 3. RD 4. GN

A-Size 7/8" Powerfast Closure Cap Selection Matrix

Material	Thread	9	10	11	12	13	14
		Mates to male cordsets and receptacles	Mates to female cordsets and receptacles	Mates to male receptacles	Mates to female receptacles	Mates to male cordsets and receptacles	Mates to female cordsets and receptacles
		6" SS Loop Lanyard	6" SS Loop Lanyard	6" SS Lanyard with Eyelet	6" SS Lanyard with Eyelet	No Lanyard	No Lanyard
Nickel Plated Brass	7/8-16 UN	RKM-CC	RSM-CC	RKF-CC	RSF-CC	RKF-MC	RSF-MC
Stainless Steel	7/8-16 UN	RKMV-CC	RSMV-CC	RKVV-CC	RSVV-CC	RKVV-MC	RSVV-MC

A-Size 7/8" Powerfast Closure Cap Dimensions

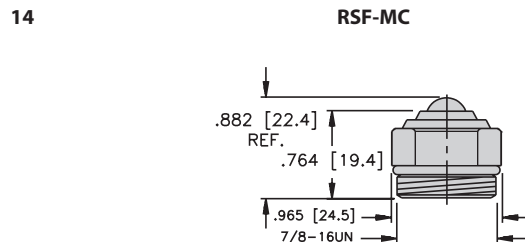
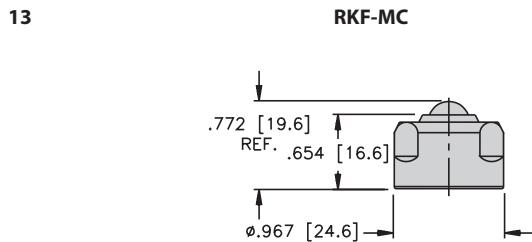
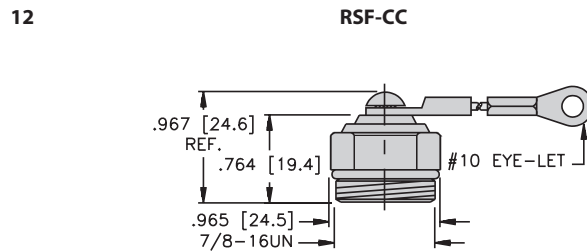
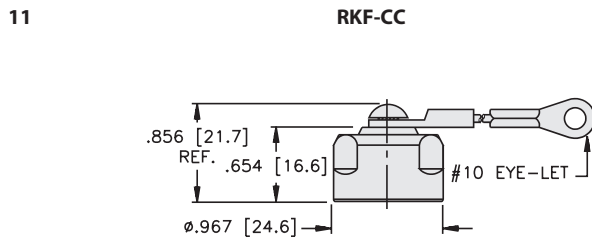
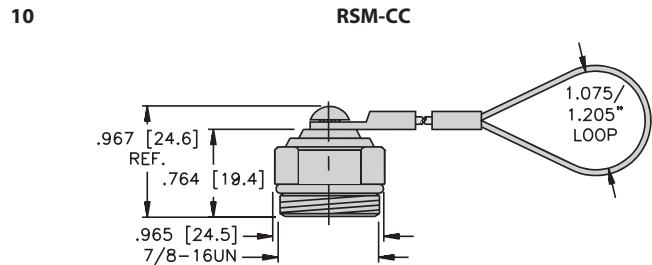
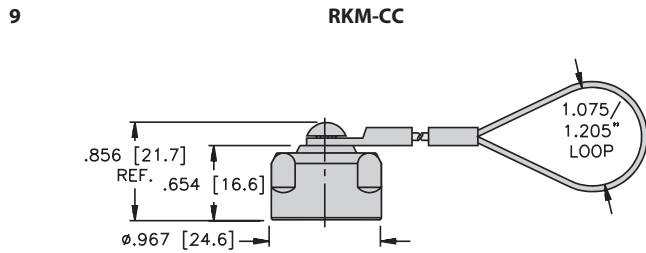

A-Size 7/8" Powerlok

Part Number	Application
LOCK-A POWER	Nylon locking guard for straight A-Size Powerfast connectors

A-Size Powerlok Open



A-Size Powerlok Closed



A-Size Powerfast Disconnect Switch Selection Matrix

We reserve the right to make technical alterations without prior notice.



Pins	AWG	Current Rating	Standard	M12 Auxiliary Output
3	14	15 Amps	RSF RKF 34/DS	RSF RKF 34/DS/AUX
4	14	15 Amps	RSF RKF 44/DS	RSF RKF 44/DS/AUX

A-Size 7/8" powerfast

Part Number Keys	J10
Cordset, Receptacle and Field Wireable Specifications	J12
Cordset, Receptacle and Field Wireable Selection Matrix	J13
Cordset, Receptacle and Field Wireable Dimensions	J15
Cordset, Receptacle and Field Wireable Pinouts	J16
Tee Specifications	J16
Tee Selection Matrix	J17
Tee Dimensions	J20
Power Reducer Specifications	J23
Power Reducer Selection Matrix	J23
Power Reducer Dimensions	J23
Tee and Power Reducer Wiring Diagrams	J24
Tee and Power Reducer Pinouts	J25
Closure Caps	J26
Powerlok Accessories	J26

Features

- Ideal for small motor applications
- 3 and 4-pin
- 14 AWG conductors
- Up to 31 Amp, 600 Volt rated
- Dual rated TC-ER and STOOW PVC cable
- "/S4000" TC-ER only PVC cable option available
- NEMA 1, 3, 4, 6P protection
- IEC IP67 protection



D-Size 1 3/8" powerfast

D-Size 1 3/8" powerfast Connectivity



D-Size 1 3/8" Powerfast Cordset Part Number Key

Part Number Keys are to assist in IDENTIFICATION ONLY. Consult factory for catalog items not identified.

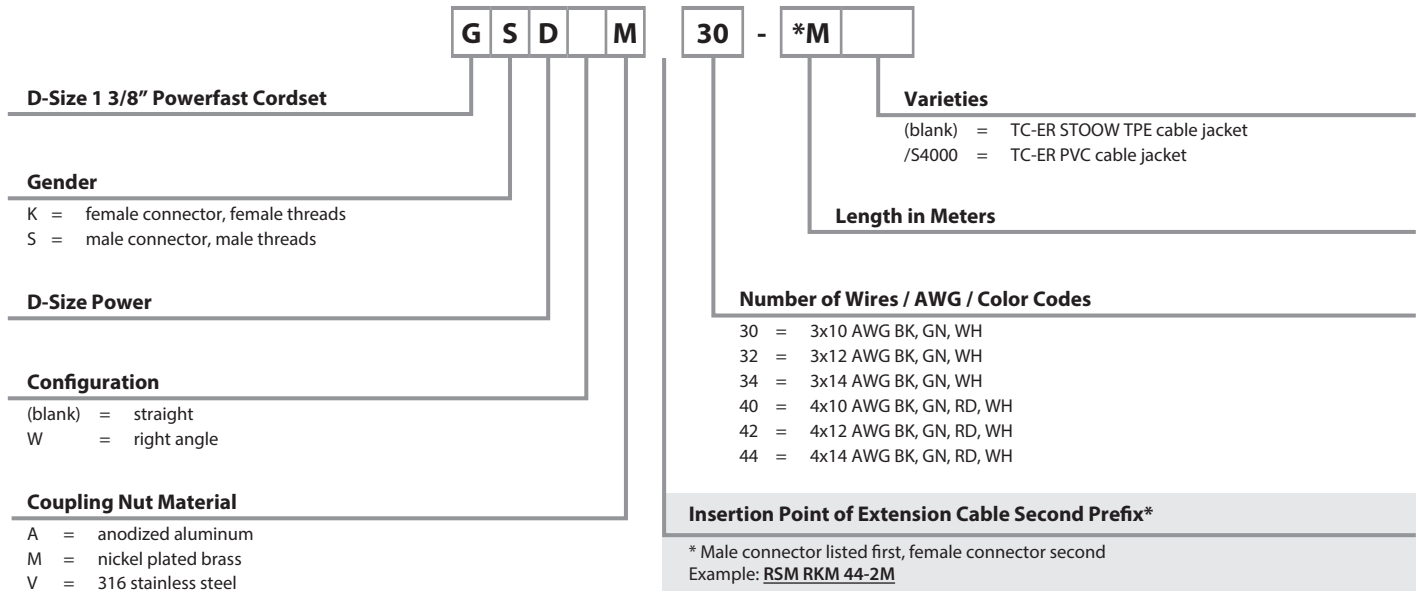

Extension Examples

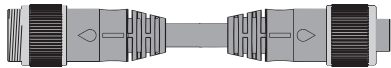

G S D M

G K D M

30 - *M

D-Size 1 3/8" Powerfast Receptacle Part Number Key

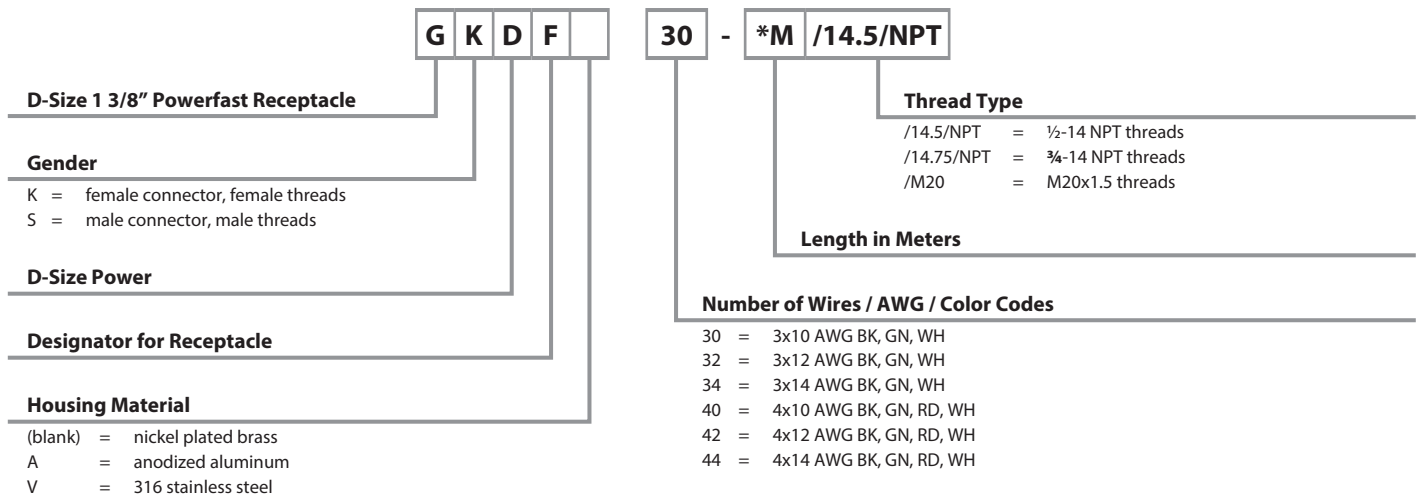

2 and 3-Wire Receptacles, Front Mount, 1/4-18 NPT Threads

Part Number Keys are to assist in IDENTIFICATION ONLY. Consult factory for catalog items not identified.

D-Size (1 3/8") Powerfast Tees

Trunk(1) Identifier
 K = female connector
 S = male connector

Coupling Nut Material
 A = anodized aluminum
 M = nickel plated brass
 V = 316 stainless steel

D-Size (1 3/8") Powerfast Tees

Trunk(2) and Drop(3) Identifiers
 2GKDM = female trunk(2) and female drop(3)
 GSDM/GKDM = male trunk(2) and female drop(3)
 GKDM/T = female trunk (2) and cable drop(3)
 GKDM/RKM = female trunk(2) and female A-Size Power drop(3)
 GKDM/BKM = female trunk(2) and female M16 Power drop(3)

30 - * - /S..

Varieties
 /S = consult factory, special
 /CS = consult factory, special
 /S4000 = designates TC-ER cable

Length in Meters

Number of Wires / AWG / Color Codes
 30 = 3x10 AWG BK, GN, WH
 32 = 3x12 AWG BK, GN, WH
 34 = 3x14 AWG BK, GN, WH
 40 = 4x10 AWG BK, GN, RD, WH
 42 = 4x12 AWG BK, GN, RD, WH
 44 = 4x14 AWG BK, GN, RD, WH

Note: Only one male connector per tee available.
 Standard female coupling nut material for A-Size Power drop and M16 Power drop is nickel plated brass.

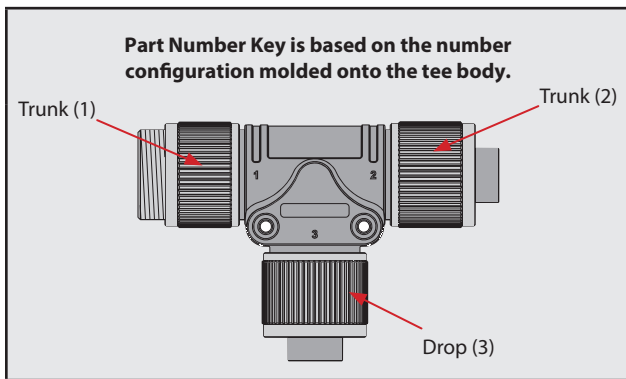

Tee Examples

G S D M / 2 G K D M 30

G S D M / G K D M / R K M 44 - *

D-Size 1 3/8" powerfast Connectivity



D-Size 1 3/8" Powerfast Cordset Specifications

Mechanical

Mold material/color:	PVC/Black
Housing material/plating:	PVC
Standard:	Nickel plated brass
Additional options:	Anodized aluminum 316 stainless steel
Environmental protection:	NEMA 1, 3, 4, 6P and IEC IP67, IP68, IP69K
Temperature rating:	-40 °C to +90 °C (-40 °F to +194 °F)

Electrical

Contact material:	Brass or copper with gold plating
Cable jacket material/color:	
Standard:	TC-ER STOOW TPE/Black
Additional options:	TC-ER PVC/Black (/S4000 version)
Ratings:	19-31 Amps, 600 VAC



D-Size 1 3/8" Powerfast Receptacle Specifications

Mechanical

Contact carrier material:	PVC
Housing material/plating:	
Standard:	Nickel plated brass
Additional options:	Anodized aluminum 316 stainless steel
Environmental protection:	NEMA 1, 3, 4, 6P and IEC IP67, IP68, IP69K
Temperature rating:	-40 °C to +105 °C (-40 °F to +221 °F)

Electrical

Contact material:	Brass or copper with gold plating
Conductor insulation:	PVC
Ratings:	19-31 Amps, 600 VAC



D-Size 1 3/8" Powerfast Field Wireable Specifications

Mechanical





Housing material/color:	Nylon/Black
Contact carrier material:	PVC
Coupling nut material:	
Standard:	Nickel plated brass
Additional options:	Anodized aluminum 316 stainless steel
Environmental protection:	NEMA 6P and IEC IP67
Temperature rating:	-40 °C to +90 °C (-40 °F to +194 °F)

Electrical

Contact material:	Brass or copper with gold plating
Ratings:	Up to 31 Amps, 600 VAC

We reserve the right to make technical alterations without prior notice.

D-Size 1 3/8" Powerfast Cordset Selection Matrix

			1 	2 	3 	4 
			Straight Female	Straight Male	Right Angle Female	Right Angle Male
Pins	AWG	Current Rating	TC-ER STOOW	TC-ER STOOW	TC-ER STOOW	TC-ER STOOW
3	10	31 Amps	GKDM 30-*M	GSDM 30-*M	GKDWM 30-*M	GSDWM 30-*M
	12	26 Amps	GKDM 32-*M	GSDM 32-*M	GKDWM 32-*M	GSDWM 32-*M
	14	23 Amps	GKDM 34-*M	GSDM 34-*M	GKDWM 34-*M	GSDWM 34-*M
4	10	28 Amps	GKDM 40-*M	GSDM 40-*M	GKDWM 40-*M	GSDWM 40-*M
	12	22 Amps	GKDM 42-*M	GSDM 42-*M	GKDWM 42-*M	GSDWM 42-*M
	14	19 Amps	GKDM 44-*M	GSDM 44-*M	GKDWM 44-*M	GSDWM 44-*M

Pins	AWG	Current Rating	TC-ER	TC-ER	TC-ER	TC-ER
3	10	31 Amps	GKDM 30-*M/S4000	GSDM 30-*M/S4000	GKDWM 30-*M/S4000	GSDWM 30-*M/S4000
	12	26 Amps	GKDM 32-*M/S4000	GSDM 32-*M/S4000	GKDWM 32-*M/S4000	GSDWM 32-*M/S4000
	14	23 Amps	GKDM 34-*M/S4000	GSDM 34-*M/S4000	GKDWM 34-*M/S4000	GSDWM 34-*M/S4000
4	10	28 Amps	GKDM 40-*M/S4000	GSDM 40-*M/S4000	GKDWM 40-*M/S4000	GSDWM 40-*M/S4000
	12	22 Amps	GKDM 42-*M/S4000	GSDM 42-*M/S4000	GKDWM 42-*M/S4000	GSDWM 42-*M/S4000
	14	19 Amps	GKDM 44-*M/S4000	GSDM 44-*M/S4000	GKDWM 44-*M/S4000	GSDWM 44-*M/S4000

See page 15 for dimensional drawings.

- * Length in meters. Standard cable lengths are 2, 5 and 10 meters. Consult factory for other lengths.
 Note: Extension cables are available, please consult Part Number Key (page 10).
 Standard coupling nut material is nickel plated brass. Consult Part Number Key (page 10) for anodized aluminum and 316 stainless steel options.





We reserve the right to make technical alterations without prior notice.



D-Size 1 3/8" powerfast

D-Size 1 3/8" powerfast Connectivity



D-Size 1 3/8" Powerfast Receptacle Selection Matrix

Front Mount			5	6	7	8
						
Pins	AWG	Current Rating	1/2-14 NPT Mounting Thread	1/2-14 NPT Mounting Thread	3/4-14 NPT Mounting Thread	3/4-14 NPT Mounting Thread
3	10	31 Amps	GKDF 30-*M/14.5/NPT	GSDF 30-*M/14.5/NPT	GKDF 30-*M/14.75/NPT	GSDF 30-*M/14.75/NPT
	12	26 Amps	GKDF 32-*M/14.5/NPT	GSDF 32-*M/14.5/NPT	GKDF 32-*M/14.75/NPT	GSDF 32-*M/14.75/NPT
	14	23 Amps	GKDF 34-*M/14.5/NPT	GSDF 34-*M/14.5/NPT	GKDF 34-*M/14.75/NPT	GSDF 34-*M/14.75/NPT
4	10	28 Amps	GKDF 40-*M/14.5/NPT	GSDF 40-*M/14.5/NPT	GKDF 40-*M/14.75/NPT	GSDF 40-*M/14.75/NPT
	12	22 Amps	GKDF 42-*M/14.5/NPT	GSDF 42-*M/14.5/NPT	GKDF 42-*M/14.75/NPT	GSDF 42-*M/14.75/NPT
	14	19 Amps	GKDF 44-*M/14.5/NPT	GSDF 44-*M/14.5/NPT	GKDF 44-*M/14.75/NPT	GSDF 44-*M/14.75/NPT

Front Mount			9	10
				
Pins	AWG	Current Rating	M20 Mounting Thread	M20 Mounting Thread
3	10	31 Amps	GKDF 30-*M/M20	GSDF 30-*M/M20
	12	26 Amps	GKDF 32-*M/M20	GSDF 32-*M/M20
	14	23 Amps	GKDF 34-*M/M20	GSDF 34-*M/M20
4	10	28 Amps	GKDF 40-*M/M20	GSDF 40-*M/M20
	12	22 Amps	GKDF 42-*M/M20	GSDF 42-*M/M20
	14	19 Amps	GKDF 44-*M/M20	GSDF 44-*M/M20

See page 15-16 for dimensional drawings.

* Length in meters. Standard lead length is 0.5 meters. Consult factory for other lengths.

Note: Standard housing material is nickel plated brass. Consult Part Number Key (page 10) for anodized aluminum and 316 stainless steel options.

We reserve the right to make technical alterations without prior notice.

D-Size 1 3/8" Powerfast Field Wireable Selection Matrix

Front Mount			11	12
				
Pins	AWG	Current Rating	Screw Terminal	Screw Terminal
3	8-14	Up to 31 Amps	GKDM 30-0	GSDM 30-0
4	8-14	Up to 28 Amps	GKDM 40-0	GSDM 40-0

See page 16 for dimensional drawings.

Note: Standard coupling nut material is nickel plated brass. Consult factory for anodized aluminum and 316 stainless steel options.

D-Size 1 3/8" Powerfast Cordset Dimensions

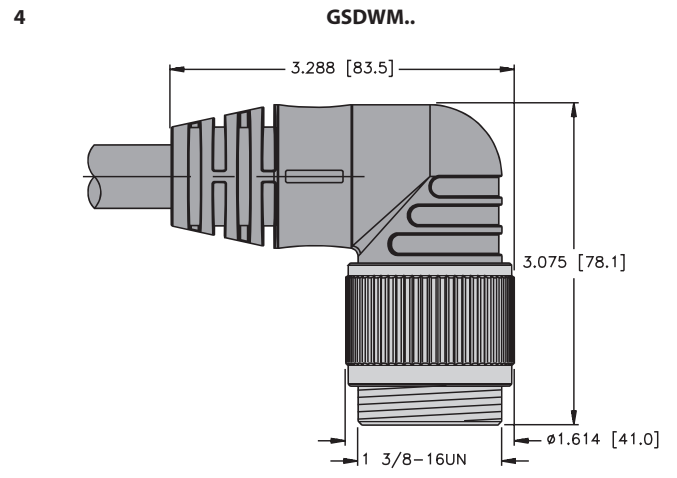
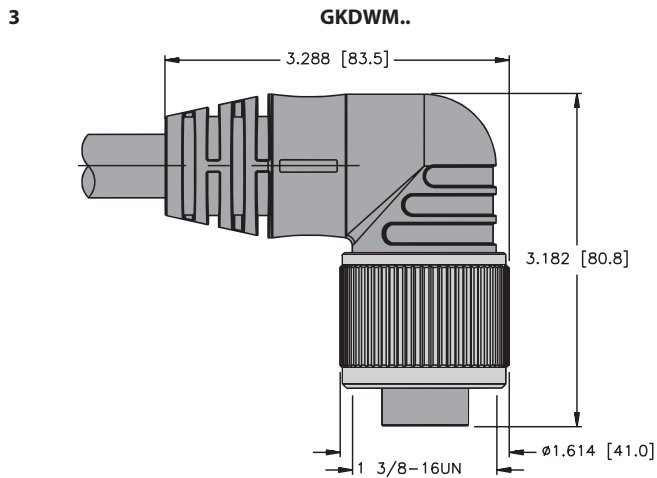
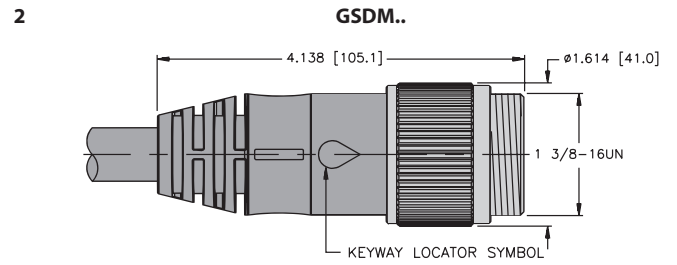
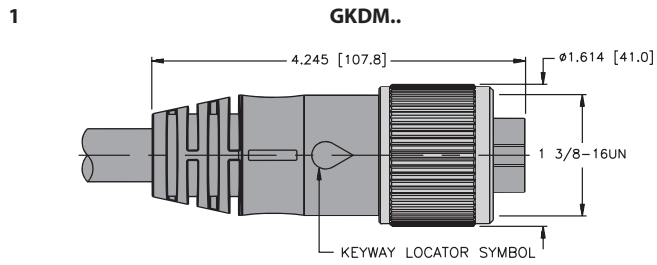

D-Size 1 3/8" Powerfast Receptacle and Field Wireable Dimensions

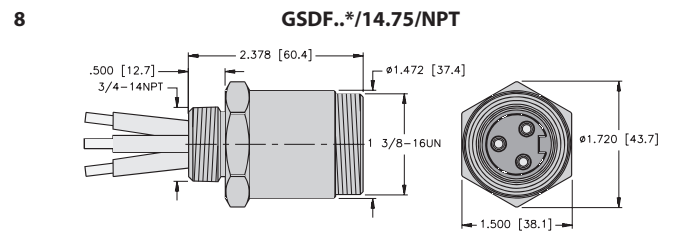
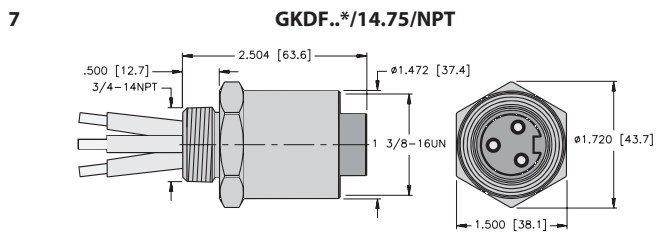
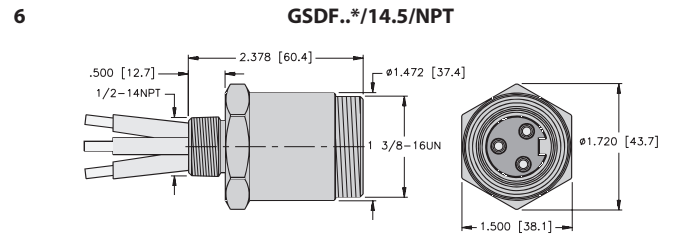
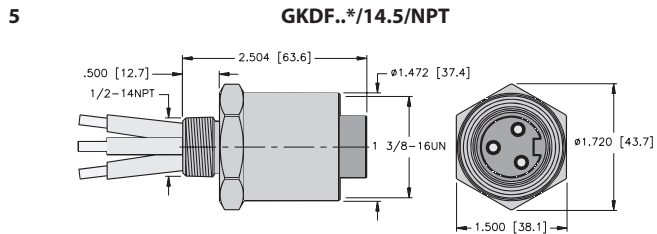

D-Size 1 3/8" powerfast

D-Size 1 3/8" powerfast Connectivity



D-Size 1 3/8" Powerfast Receptacle and Field Wireable Dimensions

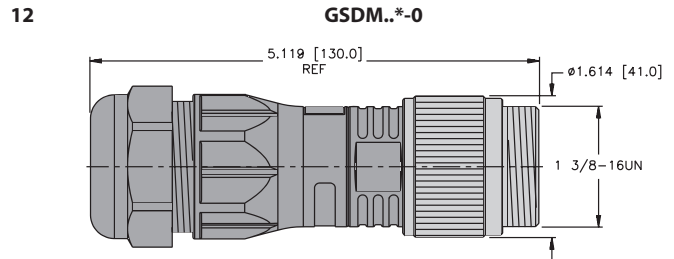
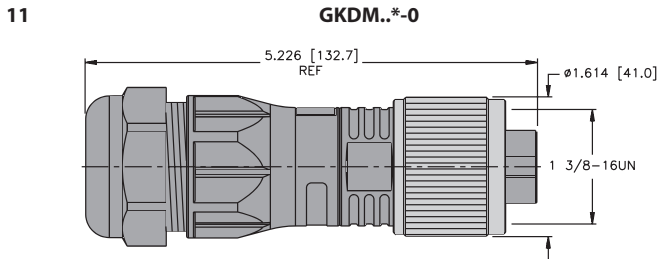
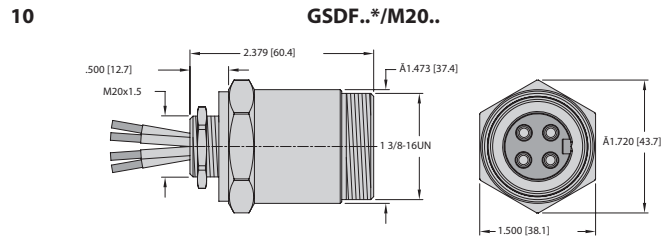
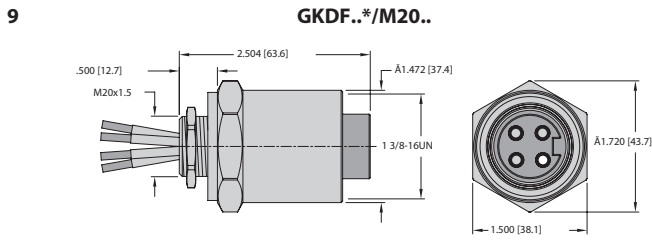

D-Size 1 3/8" Powerfast Cordset, Receptacle and Field Wireable Pinouts

3-Pin		Pinouts	4-Pin		Pinouts
Female	Male		Female	Male	
		1. BK 2. GN 3. WH			1. BK 2. GN 3. RD 4. WH

D-Size 1 3/8" Powerfast Tee Specifications

Mechanical

Mold material/color:	PVC/Black
Contact carrier material:	
Coupling nut material:	
Standard:	Nickel plated brass
Additional options:	Anodized aluminum 316 stainless steel

Environmental protection: NEMA 1, 3, 4, 6P and IEC IP67, IP68, IP69K

Temperature rating: -40 °C to +90 °C (-40 °F to +194 °F)

Electrical





Contact material:	Brass or copper with gold plating
Cable jacket material/color:	
Standard:	TC-ER STOOW TPE/Black
Additional options:	TC-ER PVC/Black (/S4000 version)
Ratings:	19-31 Amps, 600 VAC







Note: UL approval applies to D-size and A-size power connectors with integral connector drop.

We reserve the right to make technical alterations without prior notice.

D-Size 1 3/8" Powerfast Tee Selection Matrix

				13	14	15	16
							
				Integral D-Size Connector Drop	Integral A-Size Connector Drop	Dual Integral A-Size Power Connector Drop	Integral M16 Connector Drop
Pins	Drop AWG	Trunk Current Rating	Drop Current Rating				
3	10	31 Amps	31 Amps	GSDM/2GKDM 30			
	14	31 Amps	15 Amps		GSDM/GKDM/RKM 34	GSDM/2RKM 34	GSDM/GKDM/BKM 34
4	10	28 Amps	28 Amps	GSDM/2GKDM 40			
	14	28 Amps	15 Amps		GSDM/GKDM/RKM 44	GSDM/2RKM 44	GSDM/GKDM/BKM 44

				17	18	19	20
							
				Cable Drop	Cable Drop With D-Size Power Connector	Cable Drop With A-Size Power Connector	Cable Drop With M16 Power Connector
Pins	Drop AWG	Trunk Current Rating	Drop Current Rating	TC-ER STOOW	TC-ER STOOW	TC-ER STOOW	TC-ER STOOW
3	10	31 Amps	31 Amps	GSDM/GKDM/T30-*	GSDM/2GKDM 30-*		
	12	31 Amps	26 Amps	GSDM/GKDM/T32-*	GSDM/2GKDM 32-*		
	14	31 Amps	23 Amps	GSDM/GKDM/T34-*	GSDM/2GKDM 34-*	GSDM/GKDM/RKM 34-*	†
4	10	28 Amps	28 Amps	GSDM/GKDM/T40-*	GSDM/2GKDM 40-*		
	12	28 Amps	22 Amps	GSDM/GKDM/T42-*	GSDM/2GKDM 42-*		
	14	28 Amps	19 Amps	GSDM/GKDM/T44-*	GSDM/2GKDM 44-*	GSDM/GKDM/RKM 44-*	†

Pins	Drop AWG	Trunk Current Rating	Drop Current Rating	TC-ER	TC-ER	TC-ER	TC-ER
3	10	31 Amps	31 Amps	GSDM/GKDM/T30-*/S4000	GSDM/2GKDM 30-*/S4000		
	12	31 Amps	26 Amps	GSDM/GKDM/T32-*/S4000	GSDM/2GKDM 32-*/S4000		
	14	31 Amps	23 Amps	GSDM/GKDM/T34-*/S4000	GSDM/2GKDM 34-*/S4000	GSDM/GKDM/RKM 34-*/S4000†	GSDM/GKDM/BKM 34-*/S4000†
4	10	28 Amps	28 Amps	GSDM/GKDM/T40-*/S4000	GSDM/2GKDM 40-*/S4000		
	12	28 Amps	22 Amps	GSDM/GKDM/T42-*/S4000	GSDM/2GKDM 42-*/S4000		
	14	28 Amps	19 Amps	GSDM/GKDM/T44-*/S4000	GSDM/2GKDM 44-*/S4000	GSDM/GKDM/RKM 44-*/S4000†	GSDM/GKDM/BKM 44-*/S4000†

See page 19-20 for dimensional drawings.

* Length in meters.

† Drop current rating of 15 amps.

Note: Standard coupling nut material is nickel plated brass. Consult Part Number Key (page 11) for anodized aluminum and 316 stainless steel options.



We reserve the right to make technical alterations without prior notice.





D-Size 1 3/8" powerfast

D-Size 1 3/8" powerfast Connectivity



D-Size 1 3/8" Powerfast h-Style Tee Selection Matrix

				21	22	23
						
				Integral D-Size Connector Drop	Integral A-Size Connector Drop	Integral M16 Connector Drop
Pins	Drop AWG	Trunk Current Rating	Drop Current Rating			
3	10	31 Amps	31 Amps	SH-GSDM/2GKDM 30		
	14	31 Amps	15 Amps		SH-GSDM/GKDM/RKM 34-*	SH-GSDM/GKDM/BKM 34
4	10	28 Amps	28 Amps	SH-GSDM/2GKDM 40		
	14	28 Amps	15 Amps		SH-GSDM/GKDM/RKM 44-*	SH-GSDM/GKDM/BKM 44

				24	25	26	27
							
				Cable Drop	Cable Drop With D-Size Power Connector	Cable Drop With A-Size Power Connector	Cable Drop With M16 Power Connector
Pins	Drop AWG	Trunk Current Rating	Drop Current Rating	TC-ER STOOW	TC-ER STOOW	TC-ER STOOW	TC-ER STOOW
3	10	31 Amps	31 Amps	SH-GSDM/GKDM/T30-*	SH-GSDM/2GKDM 30-*		
	12	31 Amps	26 Amps	SH-GSDM/GKDM/T32-*	SH-GSDM/2GKDM 32-*		
	14	31 Amps	23 Amps	SH-GSDM/GKDM/T34-*	SH-GSDM/2GKDM 34-*	SH-GSDM/GKDM/RKM 34-*	†
4	10	28 Amps	28 Amps	SH-GSDM/GKDM/T40-*	SH-GSDM/2GKDM 40-*		
	12	28 Amps	22 Amps	SH-GSDM/GKDM/T42-*	SH-GSDM/2GKDM 42-*		
	14	28 Amps	19 Amps	SH-GSDM/GKDM/T44-*	SH-GSDM/2GKDM 44-*	SH-GSDM/GKDM/RKM 44-*	†

We reserve the right to make technical alterations without prior notice.

Pins	Drop AWG	Trunk Current Rating	Drop Current Rating	TC-ER	TC-ER	TC-ER	TC-ER
3	10	31 Amps	31 Amps	SH-GSDM/GKDM/T30-*/S4000	SH-GSDM/2GKDM 30-*/S4000		
	12	31 Amps	26 Amps	SH-GSDM/GKDM/T32-*/S4000	SH-GSDM/2GKDM 32-*/S4000		
	14	31 Amps	23 Amps	SH-GSDM/GKDM/T34-*/S4000	SH-GSDM/2GKDM 34-*/S4000	SH-GSDM/GKDM/RKM 34-*/S4000†	SH-GSDM/GKDM/BKM 34-*/S4000†
4	10	28 Amps	28 Amps	SH-GSDM/GKDM/T40-*/S4000	SH-GSDM/2GKDM 40-*/S4000		
	12	28 Amps	22 Amps	SH-GSDM/GKDM/T42-*/S4000	SH-GSDM/2GKDM 42-*/S4000		
	14	28 Amps	19 Amps	SH-GSDM/GKDM/T44-*/S4000	SH-GSDM/2GKDM 44-*/S4000	SH-GSDM/GKDM/RKM 44-*/S4000†	SH-GSDM/GKDM/BKM 44-*/S4000†

See page 21-22 for dimensional drawings.

* Length in meters.

† Drop current rating of 15 amps.

Note: Standard coupling nut material is nickel plated brass. Consult Part Number Key (page 11) for anodized aluminum and 316 stainless steel options.

2 and 3-Wire Receptacles, Front Mount, 1/4-18 NPT Threads

13

**Integral D-Size Power Connector Drop
GSDM/2GKDM..**

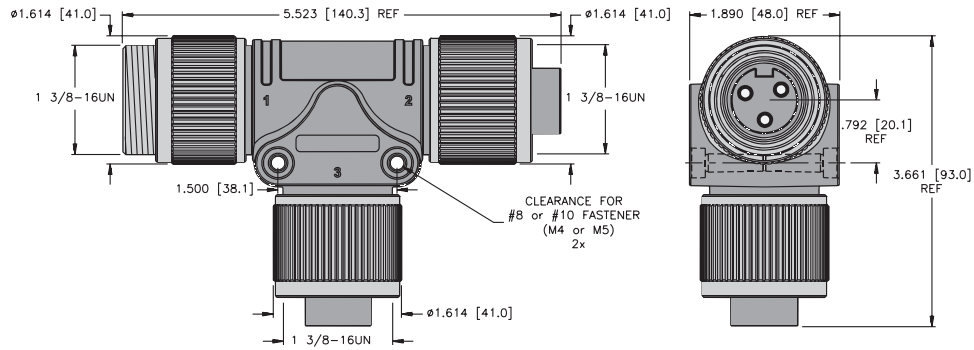

14

**Integral A-Size Power Connector Drop
GSDM/GKDM/RKM..**

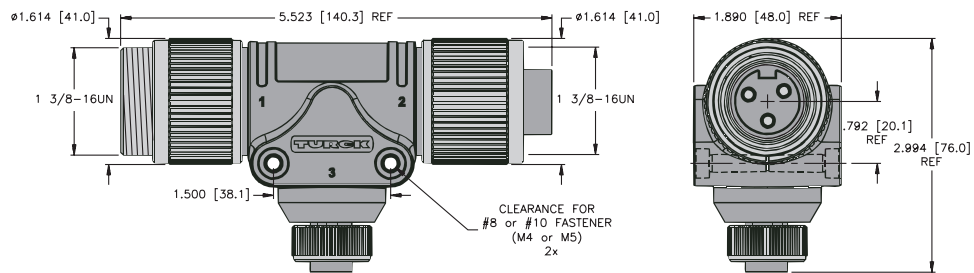

15

**Dual Integral A-Size Power Connector Drop
GSDM/2RKM..**

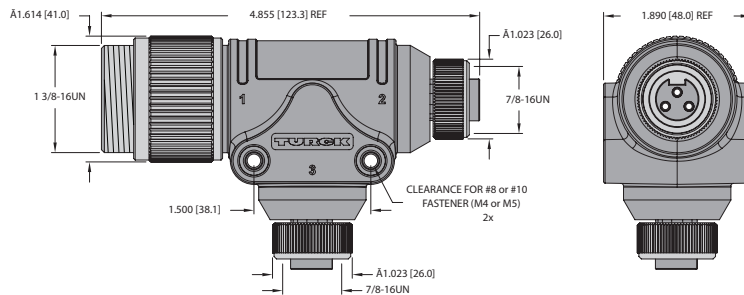

16

**Integral M16 Power Connector Drop
GSDM/GKDM/BKM..**

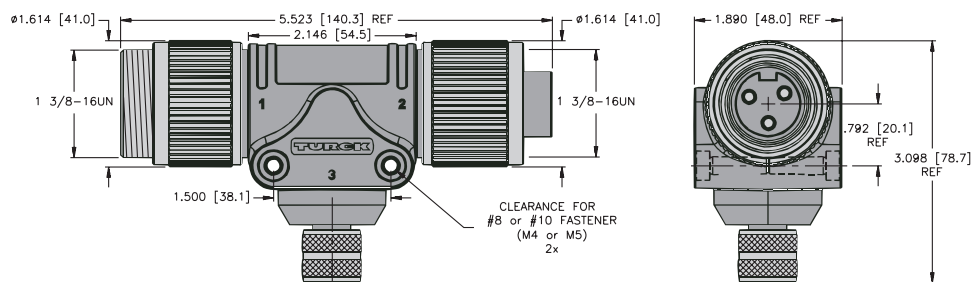

D-Size 1 3/8" powerfast

D-Size 1 3/8" Powerfast Tee Dimensions

Tee with Cable Drop and Connector Options

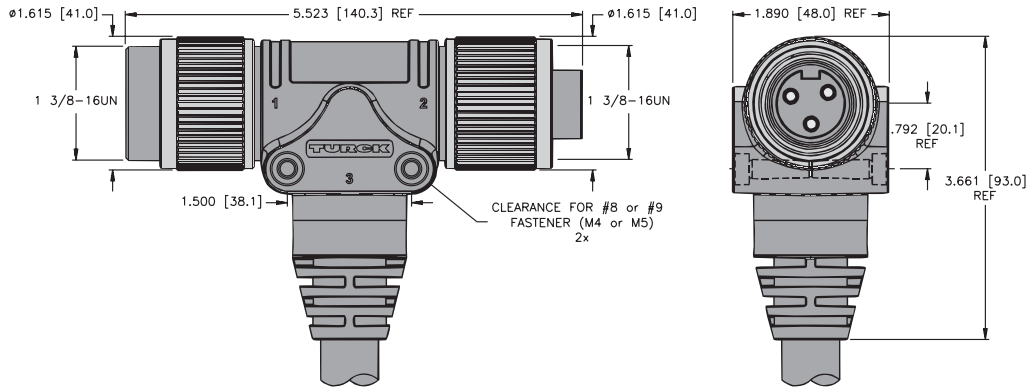

17 Cable Drop
GSDM/GKDM/T..

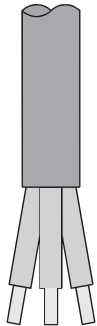

18 D-Size Power Connector
GSDM/2GKDM..

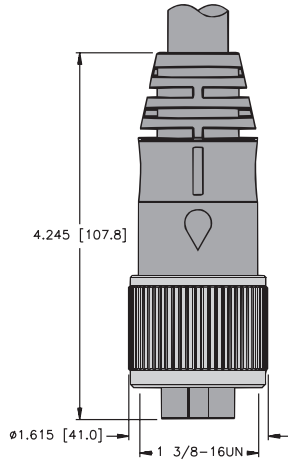

19 A-Size Power Connector
GSDM/GKDM/RKM..

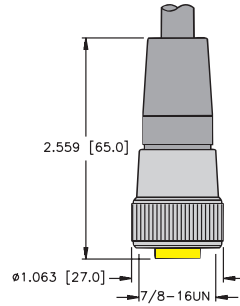

20 M16 Power Connector
GSDM/GKDM/BKM..

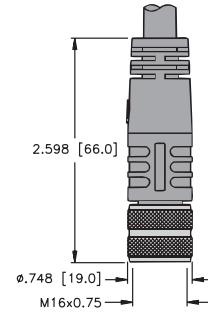

D-Size 1 3/8" Powerfast h-Style Tee Dimensions

21

**Integral D-Size Power Connector Drop
SH-GSDM/2GKDM..**

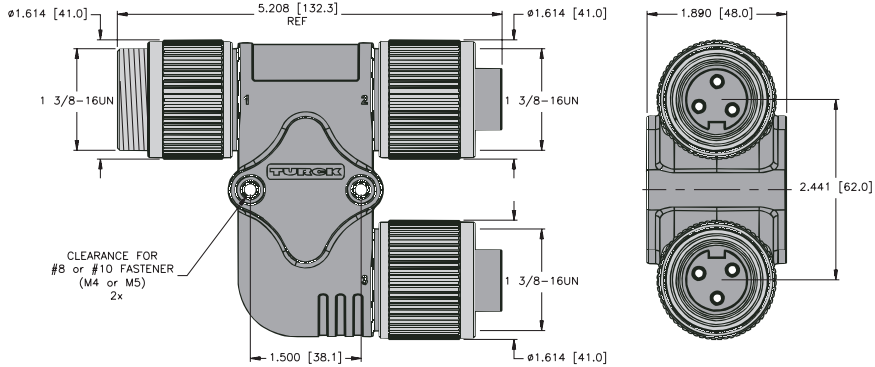

22

**Integral A-Size Power Connector Drop
SH-GSDM/GKDM/RKM..**

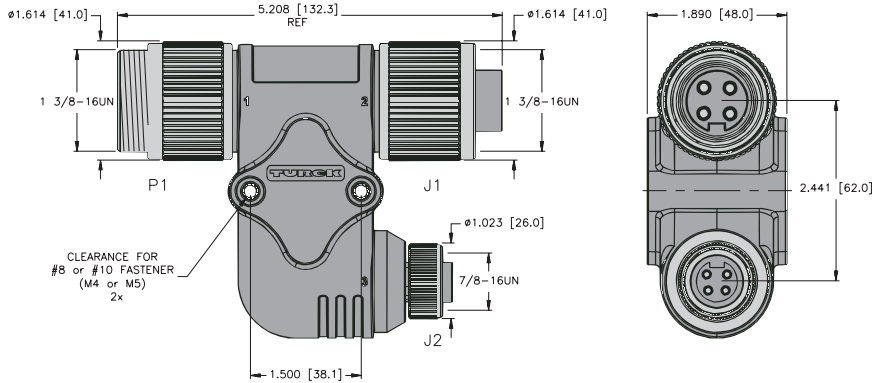

23

**Integral M16 Power Connector Drop
SH-GSDM/GKDM/BKM..**

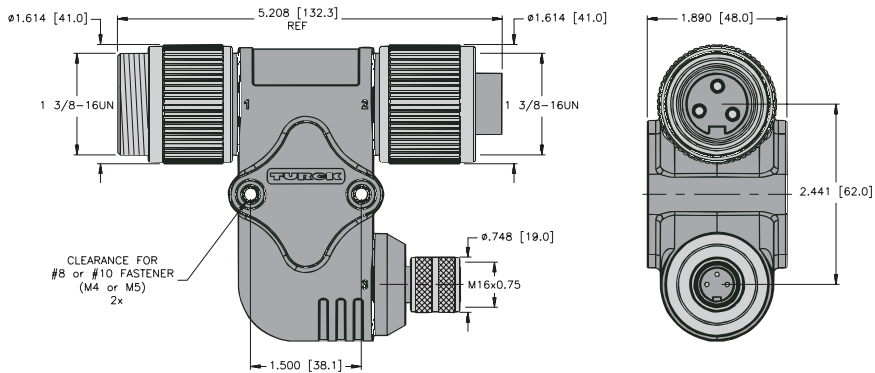

D-Size 1 3/8" powerfast

h-Style Tee with Cable Drop and Connector Options

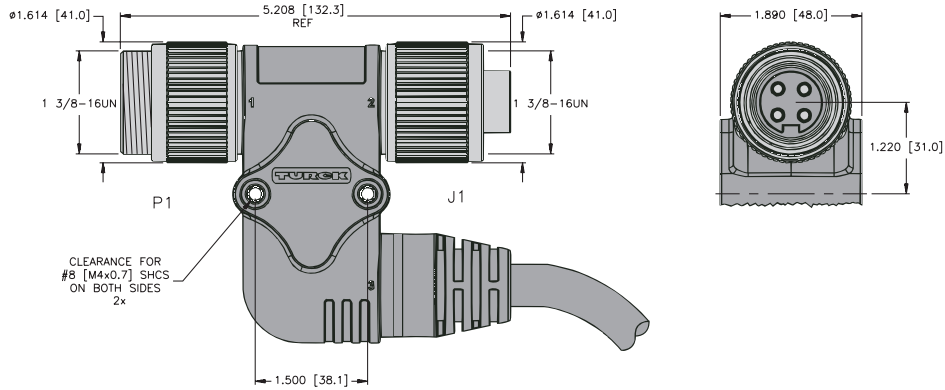

24 Cable Drop
SH-GSDM/GKDM/T

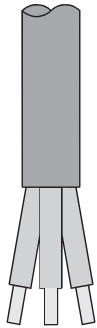

25 D-Size Power Connector
SH-GSDM/2GKDM..

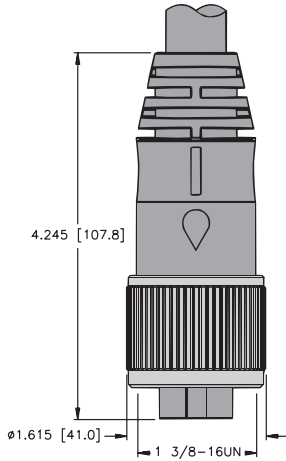

26 A-Size Power Connector
SH-GSDM/GKDM/RKM..

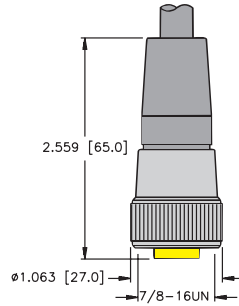

27 M16 Power Connector
SH-GSDM/GKDM/BKM..

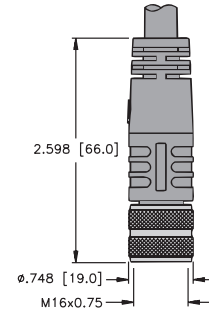

D-Size 1 3/8" Powerfast Power Reducer Specifications

Mechanical

Mold material/color:	PVC/Black
Contact carrier material:	PVC
Coupling nut material:	
Standard:	Nickel plated brass
Additional options:	Anodized aluminum 316 stainless steel
Environmental protection:	NEMA 1, 3, 4, 6P and IEC IP67, IP68, IP69K
Temperature rating:	-40 °C to +90 °C (-40 °F to +194 °F)

Electrical

Contact material:	Brass or copper with gold plating
Ratings:	15 Amps, 600 VAC



Note: UL approval applies to D-size and A-size Power connectors.

D-Size 1 3/8" Powerfast Power Reducer Selection Matrix

			28		29	
Pins	Drop AWG	Current Rating	D-Size Power to A-Size Power Reducer		D-Size Power to M16 Power Reducer	
3	14	Up to 15 Amps	GSDM RKM 34-0		GSDM BKM 34-0	
4	14	Up to 15 Amps	GSDM RKM 44-0		GSDM BKM 44-0	

See below for dimensional drawings.

Note: Standard coupling nut material is nickel plated brass. Consult factory for anodized aluminum and 316 stainless steel options.

D-Size 1 3/8" Powerfast Power Reducer Dimensions

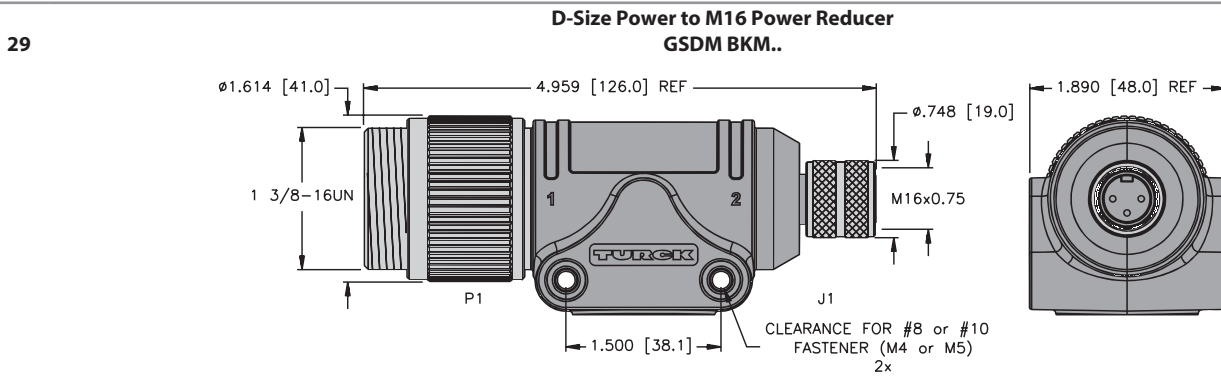
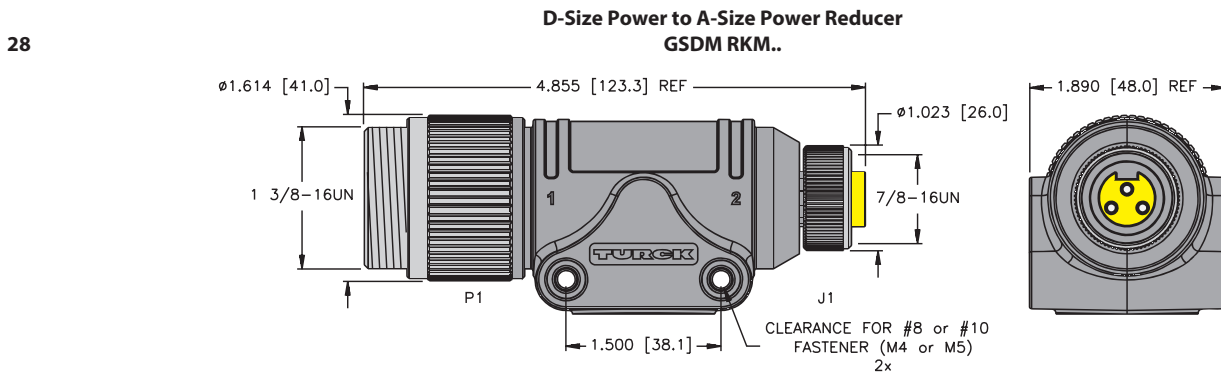

We reserve the right to make technical alterations without prior notice.

D-Size 1 3/8" powerfast

D-Size 1 3/8" powerfast Connectivity

D-Size 1 3/8" Powerfast Tee Wiring Diagrams



Cable Drop

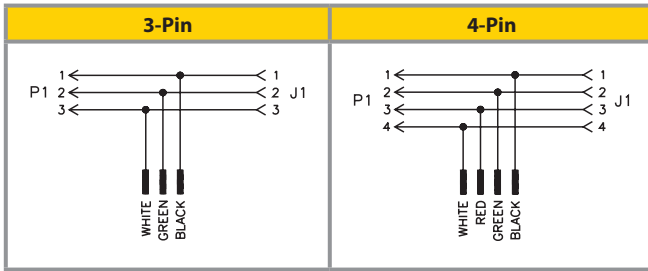

D-Size Power Drop

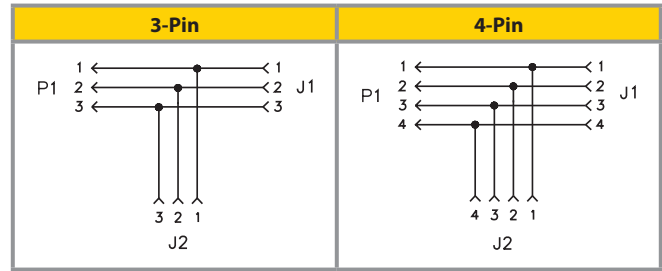

A-Size Power Drop

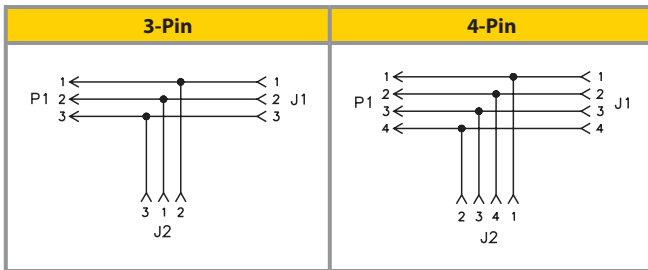

M16 Power Drop

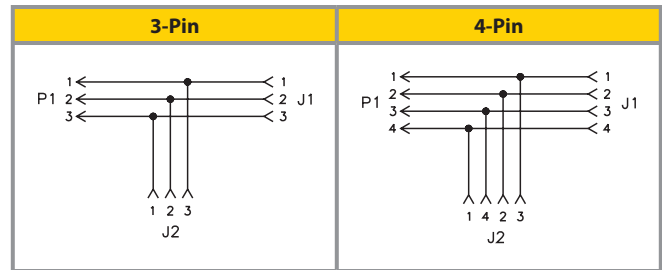

D-Size 1 3/8" Powerfast Power Reducer Wiring Diagrams

D-Size Power to A-Size Power

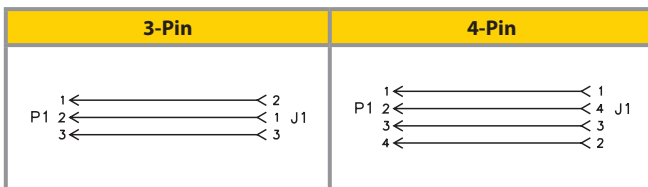

D-Size Power to M16 Power

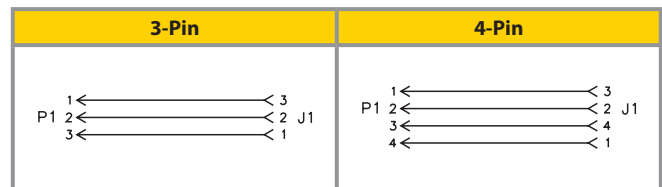

D-Size 1 3/8" Powerfast Tee and Power Reducer Pinouts

D-Size Power

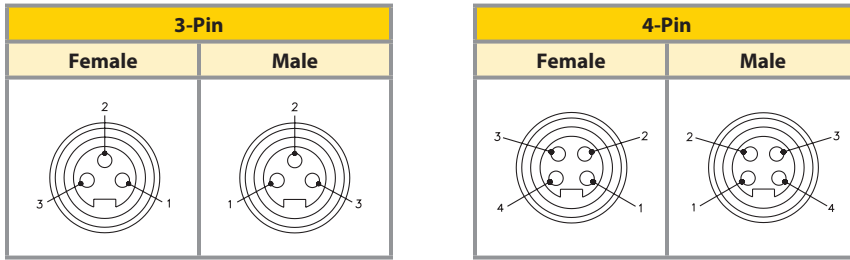

A-Size Power

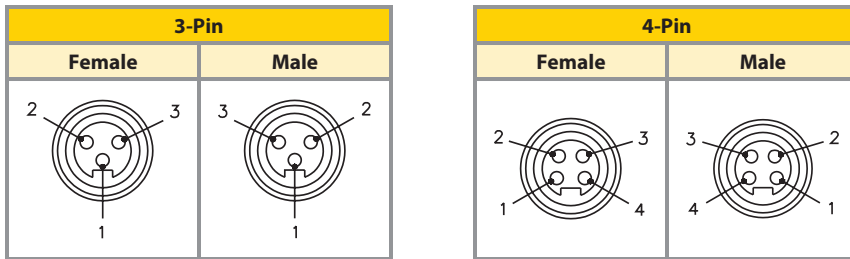

M16 Power

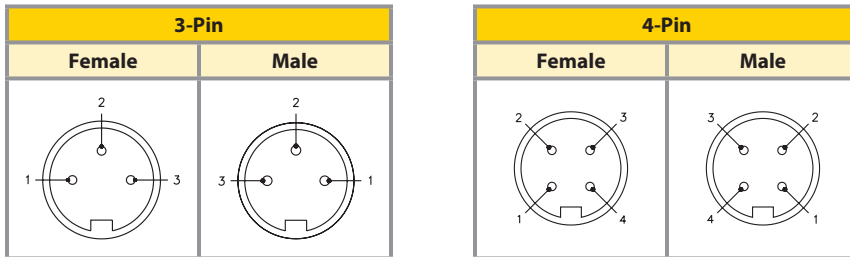

D-Size 1 3/8" powerfast Connectivity



D-Size 1 3/8" Powerfast Closure Cap Selection Matrix

		30	31	32	33	34	35
		Mates to male cordsets and receptacles	Mates to female cordsets and receptacles	Mates to male receptacles	Mates to female receptacles	Mates to male cordsets and receptacles	Mates to female cordsets and receptacles
Material	Thread	6" SS Loop Lanyard	6" SS Loop Lanyard	6" SS Lanyard with Eyelet	6" SS Lanyard with Eyelet	No Lanyard	No Lanyard
Nickel Plated Brass	1 3/8-16 UN	GKDM-CC	GSDM-CC	GKDF-CC	GSDF-CC	GKDM-MC	GSDM-MC

See table below for dimensional drawings.

D-Size 1 3/8" Powerfast Power Reducer Wiring Diagrams

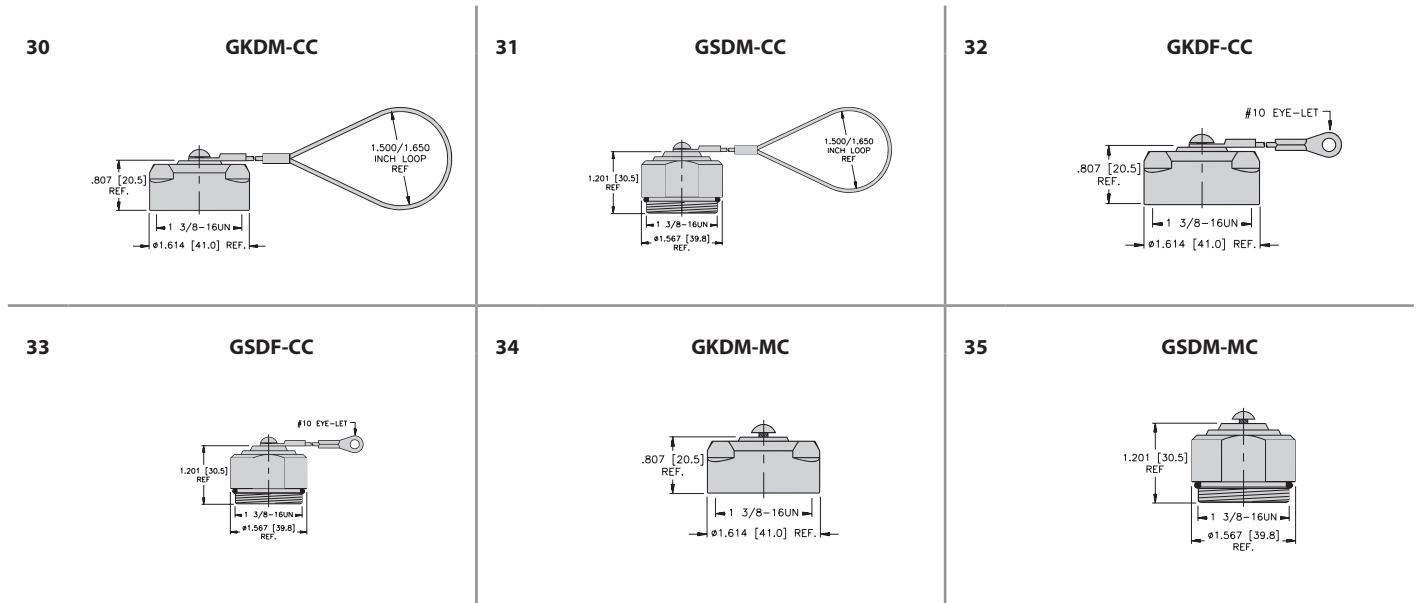

D-Size 1 3/8" Powerlok

Part Number	Application
LOCK-A POWER	Nylon locking guard for straight or right angle D-Size Powerfast connectors

A-Size Powerlok Open



A-Size Powerlok Closed



Part Number Keys	J28
Cordset, Receptacle and Field Wireable Specifications	J30
Cordset, Receptacle and Field Wireable Selection Matrix	J31
Cordset, Receptacle and Field Wireable Dimensions	J32
Cordset, Receptacle and Field Wireable Pinouts	J33
Tee Specifications	J34
Tee Selection Matrix	J34
Tee Dimensions	J35
Tee Wiring Diagrams	J41
Tee Pinouts	J41
Closure Caps	J42
Powerlok Accessories	J42

Features

- Ideal for small motor applications
- Shielded versions available
- Multiple tee configurations
- 2 to 4-pin
- 12 and 14 AWG conductors
- Up to 18 Amp, 600 Volt rated
- Tray rated-exposed run PVC cable
- IEC IP67 protection



M16 Powerfast Cordset Part Number Key

Part Number Keys are to assist in IDENTIFICATION ONLY. Consult factory for catalog items not identified.

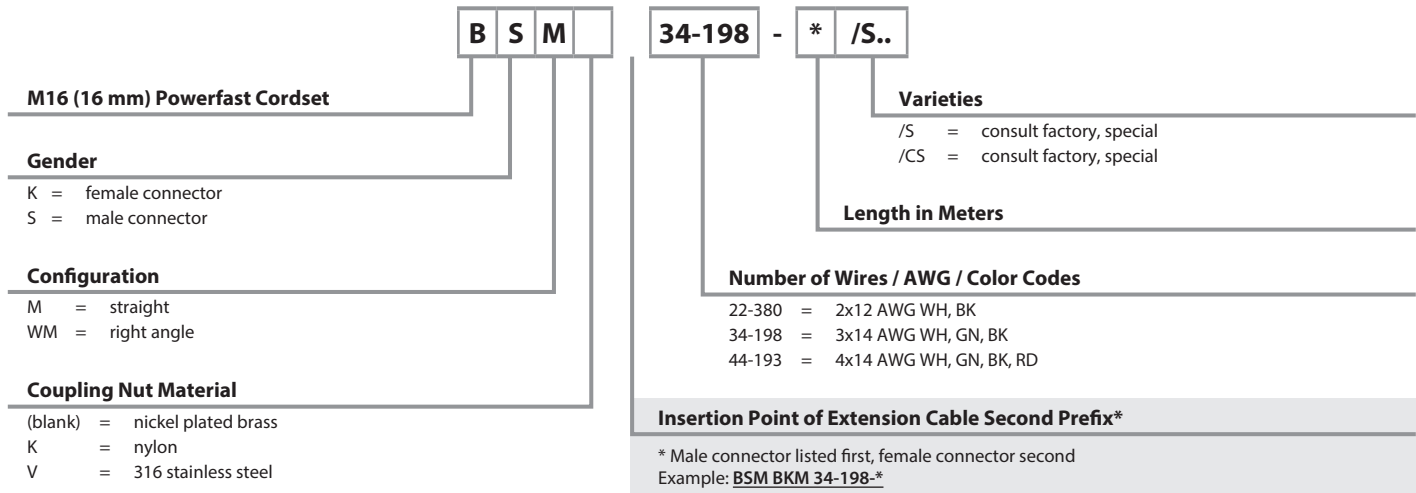

Extension Examples



M16 Powerfast Tee Part Number Key

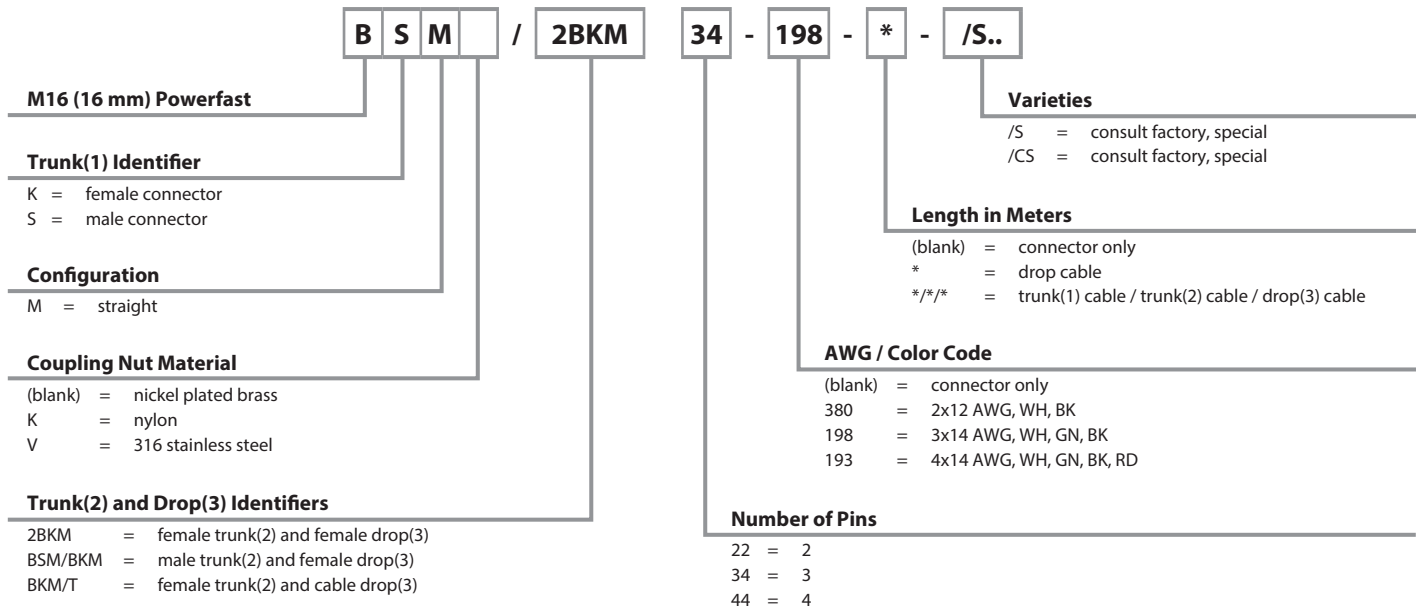

Note: Only one male connector per tee available.

Extension Examples

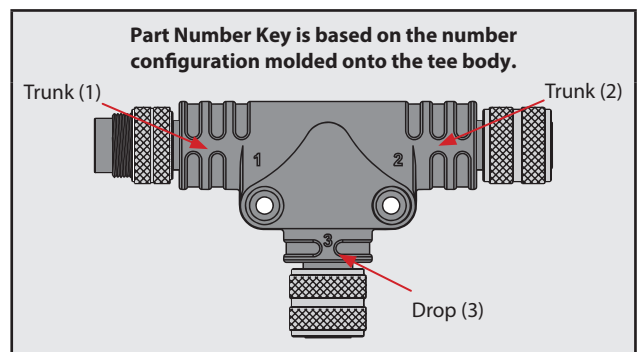

M16 Powerfast Receptacle Part Number Key

Part Number Keys are to assist in IDENTIFICATION ONLY. Consult factory for catalog items not identified.

B	K	F			22	-	*	/14.5/NPT	
M16 (16 mm) Powerfast Receptacle					Thread Type				
Gender					/14.5/NPT = 1/2-14 NPT threads				
K = female receptacle					/18.375/NPT = 3/8-18 NPT threads				
S = male receptacle					/M20 = M20 threads				
Designator for Receptacle					/M18 = M18 threads				
Housing Style					Length in Meters				
(blank) = front mount					Number of Wires / AWG / Color Codes				
D = rear mount					22 = 2x12 AWG WH, BK				
Housing Material					34 = 3x14 AWG WH, GN, BK				
(blank) = nickel plated brass					44 = 4x14 AWG WH, GN, BK, RD				
V = 316 stainless steel									

M16 Powerfast Tee Part Number Key

BH	-	B	S	M		2BKM	34	-	198	-	*	-	/S..
M16 (16 mm) Powerfast							Varieties						
BH = big H							/S = consult factory, special						
SH = small h							/CS = consult factory, special						
M16 (16 mm) Powerfast							Length in Meters						
Trunk(1) Identifier							(blank) = connector only						
K = female connector							* = drop cable						
S = male connector							**/* = trunk(1) cable / trunk(2) cable / drop(3) cable						
Configuration							**/*/* = trunk(1) cable / trunk(2) cable / drop(3) cable / drop(4) cable						
M = straight							AWG / Color Code						
Coupling Nut Material							(blank) = connector only						
(blank) = nickel plated brass							380 = 2x12 AWG, WH, BK						
K = nylon							198 = 3x14 AWG, WH, GN, BK						
V = 316 stainless steel							193 = 4x14 AWG, WH, GN, BK, RD						
Trunk(2) and Drop(3) Identifiers							Number of Pins						
2BKM = female trunk(2) and female drop(3)							22 = 2						
BSM/BKM = male trunk(2) and female drop(3)							34 = 3						
BKM/T = female trunk(2) and cable drop(3)							44 = 4						
BSM/BKM = male trunk(2) and female drop(3)													
BKM/T = female trunk(2) and cable drop(3)													

Note: Only one male connector per tee available.

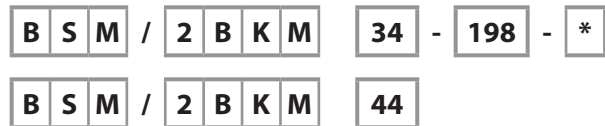
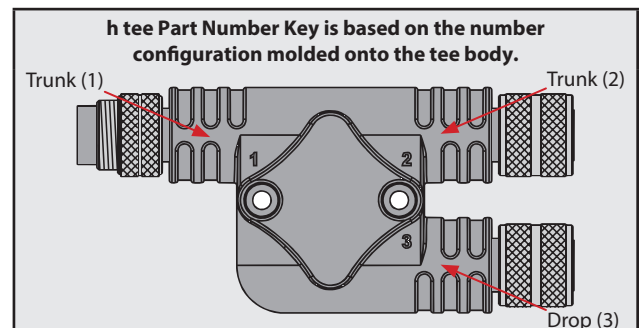
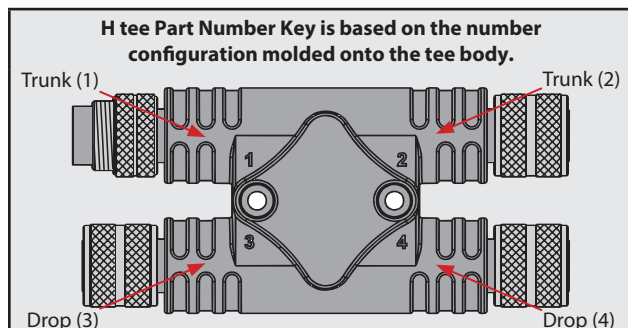

M16 Powerfast Cordset Specifications

Mechanical

Mold material/color:	PUR/Black
Contact carrier material:	PUR
Coupling nut material:	
Standard:	Nickel plated brass
Additional options:	Nylon 316 stainless steel
Environmental protection:	IEC IP67
Temperature rating:	-40 °C to +90 °C (-40 °F to +194 °F)

Electrical

Contact material:	Brass or copper with gold plating
Cable jacket material/color:	TC-ER PVC/Black
Ratings:	15-18 Amps, 600 V



M16 Powerfast Receptacle Specifications

Mechanical

Contact carrier material:	PUR
Housing material/plating:	
Standard:	Nickel plated brass
Additional options:	316 stainless steel
O-Ring material:	Nitrile (BUNA-N)
Environmental protection:	IEC IP67
Temperature rating:	-40 °C to +105 °C (-40 °F to +221 °F)

Electrical

Contact material:	Brass or copper with gold plating
Conductor insulation:	PVC
Ratings:	15-18 Amps, 600 V



M16 Powerfast Field Wireable Specifications





Mechanical

Housing material/color:	Glass filled nylon or PVC/Black
Contact carrier material:	PUR
Coupling nut material:	
Standard:	Nickel plated brass
Additional options:	Nylon 316 stainless steel
Environmental protection:	NEMA 6P and IEC IP67
Temperature rating:	-40 °C to +90 °C (-40 °F to +194 °F)

Electrical

Contact material:	Brass or copper with gold plating
Ratings:	15-18 Amps, 600 VAC





M16 Powerfast Cordset Selection Matrix





			1 	2 	3 	4 
			Straight Female	Straight Male	Right Angle Female	Right Angle Male
Pins	AWG	Current Rating	TC-ER	TC-ER	TC-ER	TC-ER
2	12	18 Amps	BKM 22-380-*	BSM 22-380-*	BKWM 22-380-*	BSWM 22-380-*
3	14	15 Amps	BKM 34-198-*	BSM 34-198-*	BKWM 34-198-*	BSWM 34-198-*
4	14	15 Amps	BKM 44-193-*	BSM 44-193-*	BKWM 44-193-*	BSWM 44-193-*



Pins	AWG	Current Rating	SHIELDED TC-ER	SHIELDED TC-ER	SHIELDED TC-ER	SHIELDED TC-ER
2	12	18 Amps	BKMS 22-1759-*	BSMS 22-1759-*	BKWMS 22-1759-*	BSWMS 22-1759-*
3	14	15 Amps	BKMS 34-1364-*	BSMS 34-1364-*	BKWMS 34-1364-*	BSWMS 34-1364-*
4	14	15 Amps	BKMS 44-1363-*	BSMS 44-1363-*	BKWMS 44-1363-*	BSWMS 44-1363-*

We reserve the right to make technical alterations without prior notice.

2 and 3-Wire Receptacles, Front Mount, 1/4-18 NPT Threads

Front Mount			5		6		7		8	
			Female		Male		Female		Male	
Pins	AWG	Current Rating	1/2-14 NPT Mounting Thread	1/2-14 NPT Mounting Thread	3/8-18 NPT Mounting Thread	3/8-18 NPT Mounting Thread				
2	12	18 Amps	BKF 22-*/14.5/NPT	BSF 22-*/14.5/NPT	BKF 22-*/18.375/NPT	BSF 22-*/18.375/NPT				
3	14	15 Amps	BKF 34-*/14.5/NPT	BSF 34-*/14.5/NPT	BKF 34-*/18.375/NPT	BSF 34-*/18.375/NPT				
4	14	15 Amps	BKF 44-*/14.5/NPT	BSF 44-*/14.5/NPT	BKF 44-*/18.375/NPT	BSF 44-*/18.375/NPT				

Front Mount			9		10		11		12	
			Female		Male		Female		Male	
Pins	AWG	Current Rating	M18 Mounting Thread	M18 Mounting Thread	M20 Mounting Thread	M20 Mounting Thread				
2	12	18 Amps	BKF 22-*/M18	BSF 22-*/M18	BKF 22-*/M20	BSF 22-*/M20				
3	14	15 Amps	BKF 34-*/M18	BSF 34-*/M18	BKF 34-*/M20	BSF 34-*/M20				
4	14	15 Amps	BKF 44-*/M18	BSF 44-*/M18	BKF 44-*/M20	BSF 44-*/M20				

Front Mount			13		14	
			Female		Male	
Pins	AWG	Current Rating	M18 Mounting Thread	M18 Mounting Thread		
2	12	18 Amps	BKFD 22-*/M18	BSFD 22-*/M18		
3	14	15 Amps	BKFD 34-*/M18	BSFD 34-*/M18		
4	14	15 Amps	BKFD 44-*/M18	BSFD 44-*/M18		

See pages 32-33 for dimensional drawings.



* Length in meters. Standard lead length is 0.5 meters. Consult factory for other lengths.

Note: Standard housing material is nickel plated brass. Consult Part Number Key (page 27) for 316 stainless steel options.

We reserve the right to make technical alterations without prior notice.

M16 powerfast

M16 Powerfast Field Wireable Selection Matrix

			15		16	
			Straight Female, PG 11 Cable Gland Accepts 8-11 mm Cable Diameter		Straight Male, PG 11 Cable Gland Accepts 8-11 mm Cable Diameter	
Pins	Acceptable Conductor AWG	Current Rating	Screw Terminal		Screw Terminal	
2	12	18 Amps	BK 22-0		BS 22-0	
3	14	15 Amps	BK 34-0		BS 34-0	
4	14	15 Amps	BK 44-0		BS 44-0	

See page 33 for dimensional drawings.

* Note: Standard coupling nut material is nickel plated brass. Consult factory for nylon and 316 stainless steel options.

<p>1 BKM..</p>	<p>2 BSM..</p>
<p>3 BKWM..</p>	<p>4 BSWM..</p>
<p>5 BKF../14.5/NPT</p>	<p>6 BSF../14.5/NPT</p>
<p>7 BKF../18.375/NPT</p>	<p>8 BSF../18.375/NPT</p>
<p>9 BKF../M18</p>	<p>10 BSF../M18</p>
<p>11 BKF../M20</p>	<p>12 BSF../M20</p>

M16 Powerfast Cordset, Receptacle and Field Wireable Dimensions

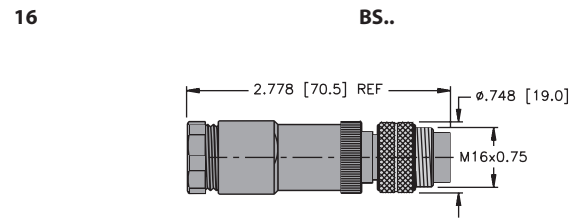
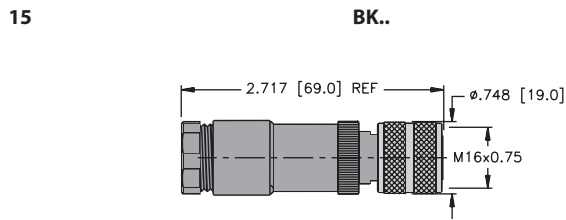
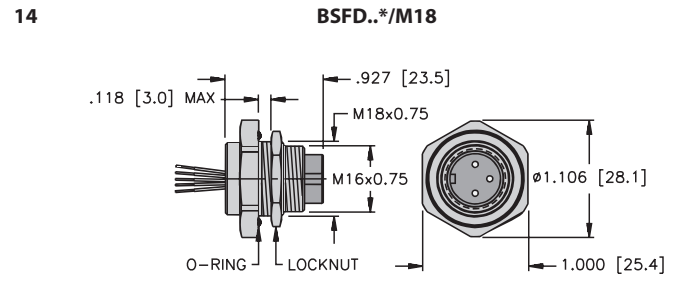
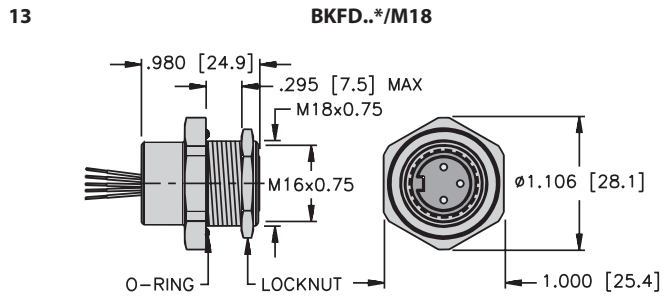

M16 Powerfast Cordset, Receptacle and Field Wireable Pinouts

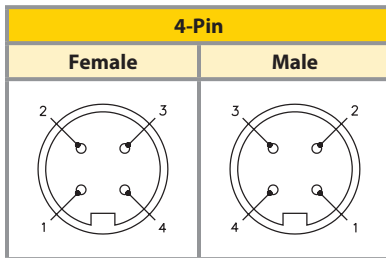
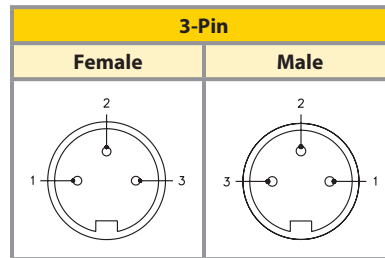
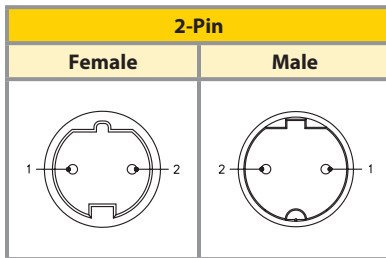

M16 powerfast

M16 Powerfast Tee Specifications

Mechanical

Mold material/color:	PUR/Black
Contact carrier material:	PUR
Housing material/plating:	
Standard:	Nickel plated brass
Additional options:	Nylon 316 stainless steel

Environmental protection: IEC IP67

Temperature rating:

Integral connector version:	-40 °C to +105 °C (-40 °F to +221 °F)
Cable version:	-40 °C to +90 °C (-40 °F to +194 °F)

Electrical

Contact material:	Brass or copper with gold plating
Cable jacket material/color:	TC-ER PVC/Black
Ratings:	15-18 Amps, 600 V



M16 Powerfast Tee Selection Matrix

			17	18	19	20
			Integral M16 Power Connector Drop	Cable Drop with M16 Power Connector	Cable Trunk and Cable Drop with M16 Power Connectors	Cable Drop
Pins	AWG	Current Rating	TC-ER		TC-ER	
2	12	18 Amps	BSM/2BKM 22	BSM/2BKM 22-380-*	BSM/2BKM 22-380-*/*/*	BSM/BKM/T22-380-*
3	14	15 Amps	BSM/2BKM 34	BSM/2BKM 34-198-*	BSM/2BKM 34-198-*/*/*	BSM/BKM/T34-198-*
4	14	15 Amps	BSM/2BKM 44	BSM/2BKM 44-193-*	BSM/2BKM 44-193-*/*/*	BSM/BKM/T44-193-*

We reserve the right to make technical alterations without prior notice.

M16 Powerfast h-Style Tee Selection Matrix

			21	22	23	24
			Integral M16 Power Connector Drop	Cable Drop with M16 Power Connector	Cable Trunk and Cable Drop with M16 Power Connectors	Cable Drop
Pins	AWG	Current Rating	TC-ER		TC-ER	
2	12	18 Amps	SH-BSM/2BKM 22	SH-BSM/2BKM 22-380-*	SH-BSM/2BKM 22-380-*/*/*	SH-BSM/BKM/T22-380-*
3	14	15 Amps	SH-BSM/2BKM 34	SH-BSM/2BKM 34-198-*	SH-BSM/2BKM 34-198-*/*/*	SH-BSM/BKM/T34-198-*
4	14	15 Amps	SH-BSM/2BKM 44	SH-BSM/2BKM 44-193-*	SH-BSM/2BKM 44-193-*/*/*	SH-BSM/BKM/T44-193-*

			25	26	27	28
			Integral M16 Power Connector Drop	Cable Drop with M16 Power Connector	Cable Trunk and Cable Drop with M16 Power Connectors	Cable Drop
Pins	AWG	Current Rating	TC-ER		TC-ER	
2	12	18 Amps	SH-BKM/BSM/BKM 22	SH-BKM/BSM/BKM 22-380-*	SH-BKM/BSM/BKM 22-380-*/*/*	SH-BKM/BSM/T22-380-*
3	14	15 Amps	SH-BKM/BSM/BKM 34	SH-BKM/BSM/BKM 34-198-*	SH-BKM/BSM/BKM 34-198-*/*/*	SH-BKM/BSM/T34-198-*
4	14	15 Amps	SH-BKM/BSM/BKM 44	SH-BKM/BSM/BKM 44-193-*	SH-BKM/BSM/BKM 44-193-*/*/*	SH-BKM/BSM/T44-193-*

2 and 3-Wire Receptacles, Front Mount, 1/4-18 NPT Threads

			29	30	31
Trunk #1: Male Connector			Integral M16 Power Connector Drop	Cable Drop with M16 Power Connector	Cable Trunk and Cable Drop with M16 Power Connectors
Pins	AWG	Current Rating	TC-ER		TC-ER
2	12	18 Amps	BH-BSM/3BKM 22	BH-BSM/3BKM 22-380-*	BH-BSM/3BKM 22-380-*/*/**
3	14	15 Amps	BH-BSM/3BKM 34	BH-BSM/3BKM 34-198-*	BH-BSM/3BKM 34-198-*/*/**
4	14	15 Amps	BH-BSM/3BKM 44	BH-BSM/3BKM 44-193-*	BH-BSM/3BKM 44-193-*/*/**

			32	33	34
Trunk #1: Male Connector			Integral M16 Power Connector Drop	Cable Drop with M16 Power Connector	Cable Trunk and Cable Drop with M16 Power Connectors
Pins	AWG	Current Rating	TC-ER		TC-ER
2	12	18 Amps	BH-BKM/BSM/2BKM 22	BH-BKM/BSM/2BKM 22-380-*	BH-BKM/BSM/2BKM 22-380-*/*/**
3	14	15 Amps	BH-BKM/BSM/2BKM 34	BH-BKM/BSM/2BKM 34-198-*	BH-BKM/BSM/2BKM 34-198-*/*/**
4	14	15 Amps	BH-BKM/BSM/2BKM 44	BH-BKM/BSM/2BKM 44-193-*	BH-BKM/BSM/2BKM 44-193-*/*/**

See pages 35-40 for dimensional drawings.

* Length in meters. Standard cable lengths are 2, 5 and 10 meters. Consult factory for other lengths.

Note: Standard coupling nut material is nickel plated brass. Consult Part Number Key (page 27) for nylon and 316 stainless steel options.

We reserve the right to make technical alterations without prior notice.

M16 powerfast

M16 Powerfast Tee Dimensions

17

**Integral M16 Power Connector Drop
BSM/2BKM..**

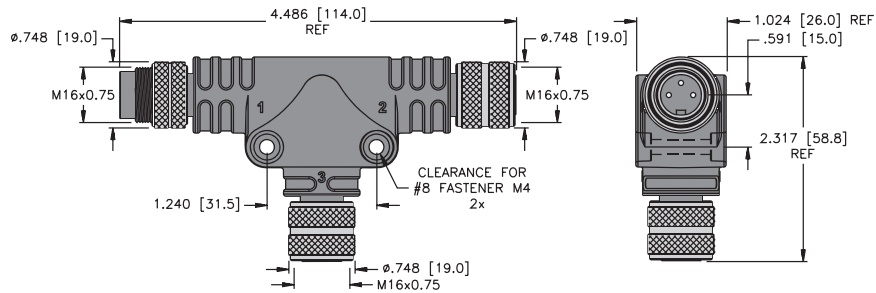

M16 Powerfast Tee Dimensions

18

Cable Drop with M16 Power Connector
BSM/2BKM..

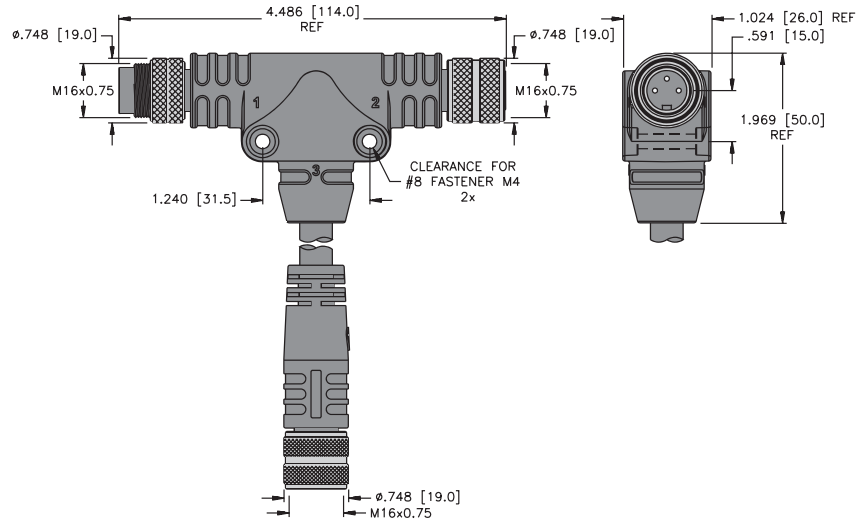

19

Cable Trunk and Cable Drop with M16 Power Connectors
BSM/2BKM..

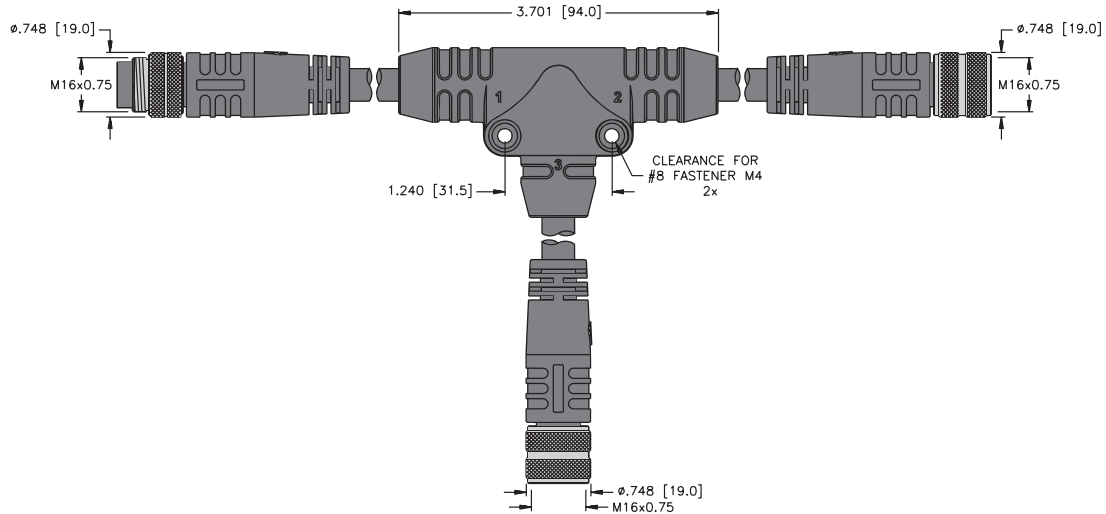

20

Cable Drop
BSM/BKM/T..

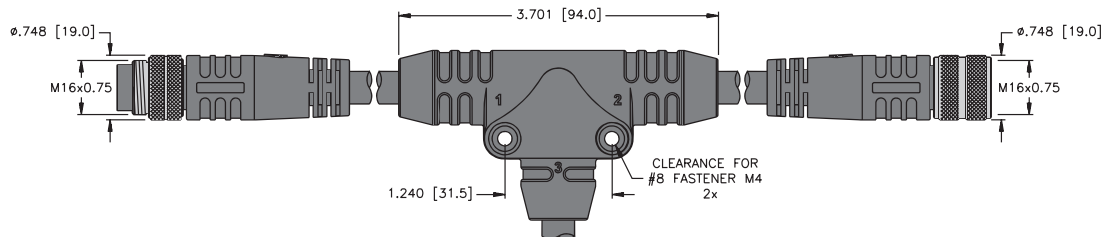

M16 Powerfast h-Style Tee Dimensions

21

Integral M16 Power Connector Drop, Trunk #1 Male
SH-BSM/2BKM..

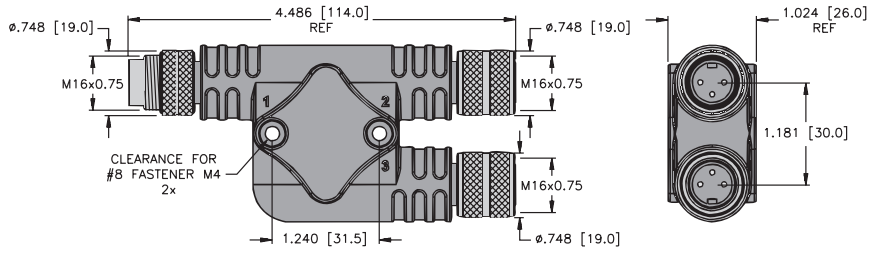

22

Cable Drop with M16 Power Connector, Trunk #1 Male
SH-BSM/2BKM..

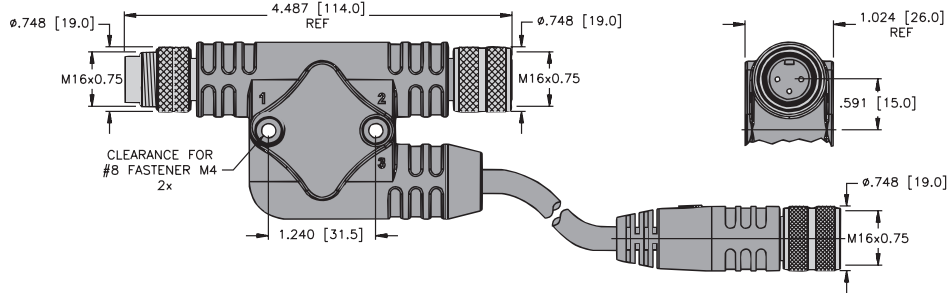

23

Cable Trunk and Cable Drop with M16 Power Connectors, Trunk #1 Male
SH-BSM/2BKM..

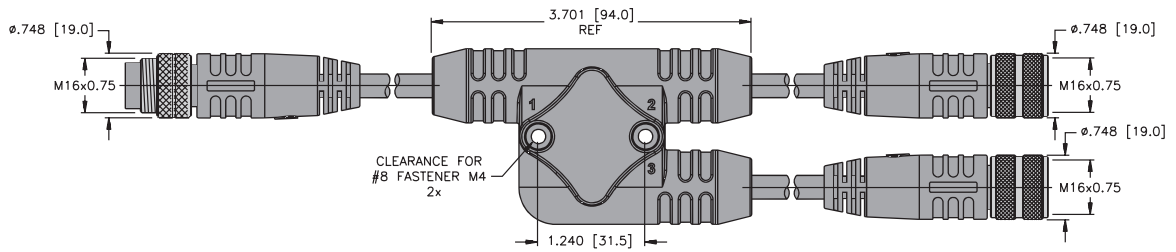

24

Cable Drop, Trunk #1 Male
SH-BSM/BKM/T..

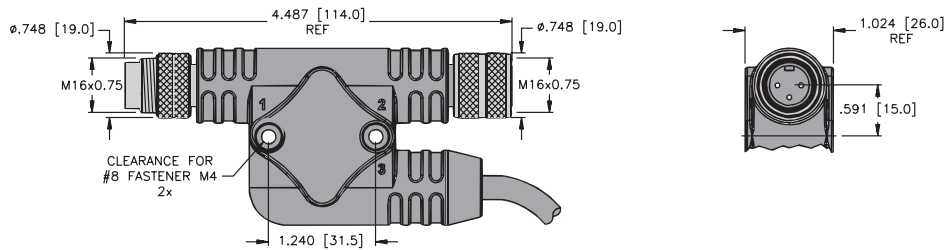

M16 powerfast

M16 Powerfast h-Style Tee Dimensions

25

**Integral M16 Power Connector Drop, Trunk #2 Male
SH-BKM/BSM/BKM..**

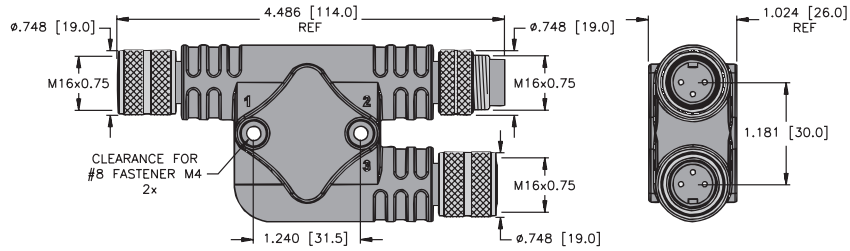

26

**Cable Drop with M16 Power Connector, Trunk #2 Male
SH-BKM/BSM/BKM..**

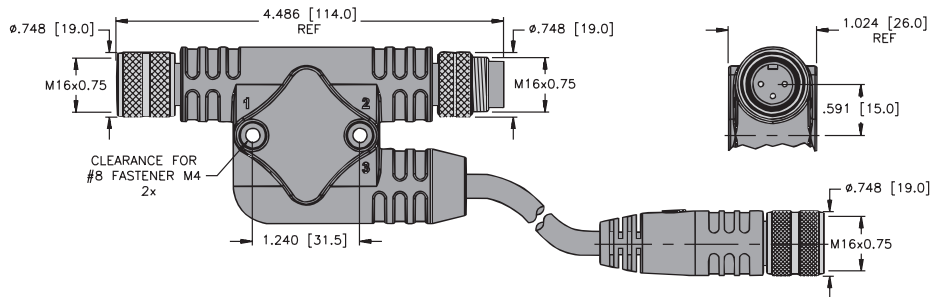

27

**Cable Trunk and Cable Drop with M16 Power Connectors, Trunk #2 Male
SH-BKM/BSM/BKM..**

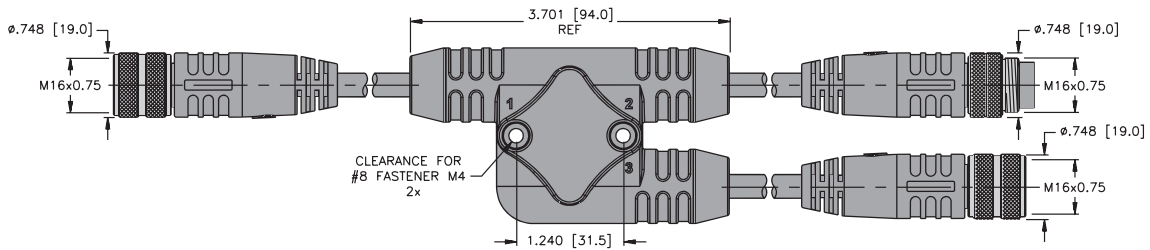

28

**Cable Drop, Trunk #2 Male
SH-BKM/BSM/T..**

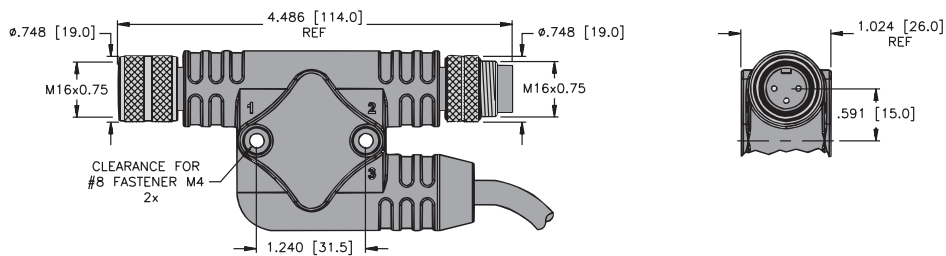

M16 Powerfast H-Style Tee Dimensions

29

**Integral M16 Power Connector Drop, Trunk #1 Male
BH-BSM/3BKM..**

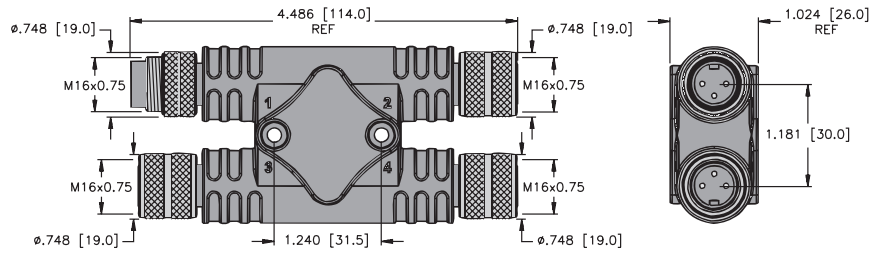

30

**Cable Drop with M16 Power Connector, Trunk #1 Male
BH-BSM/3BKM..**

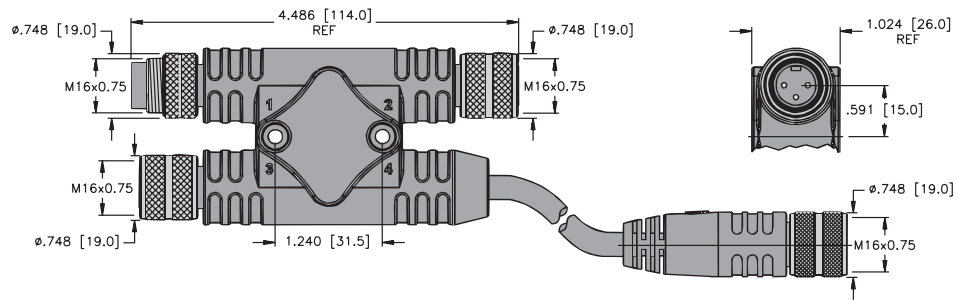

31

**Cable Trunk and Cable Drop with M16 Power Connectors, Trunk #1 Male
BH-BSM/3BKM..**

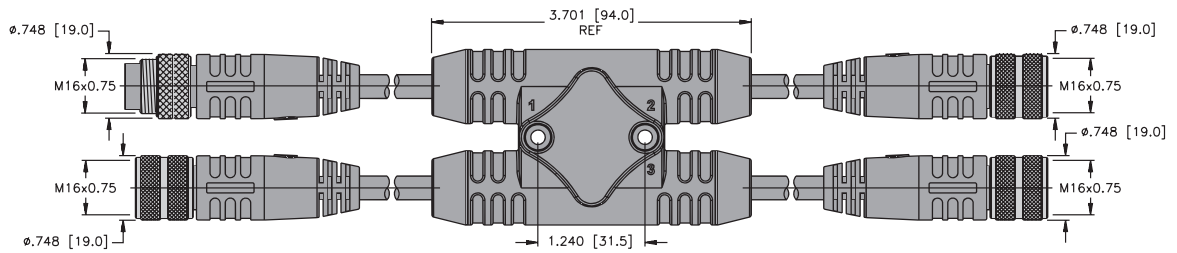

M16 powerfast

M16 Powerfast H-Style Tee Dimensions

32

**Integral M16 Power Connector Drop, Trunk #2 Male
BH-BKM/BSM/2BKM..**

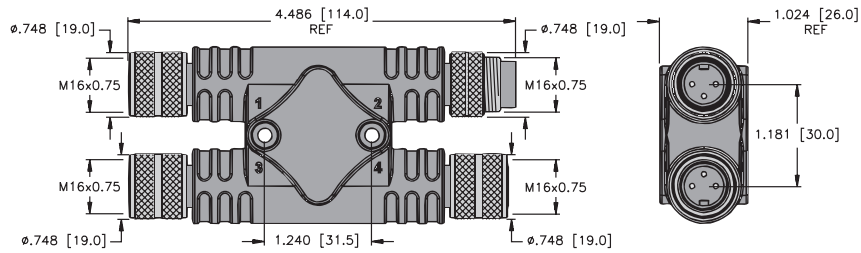

33

**Cable Drop with M16 Power Connector, Trunk #2 Male
BH-BKM/BSM/2BKM..**

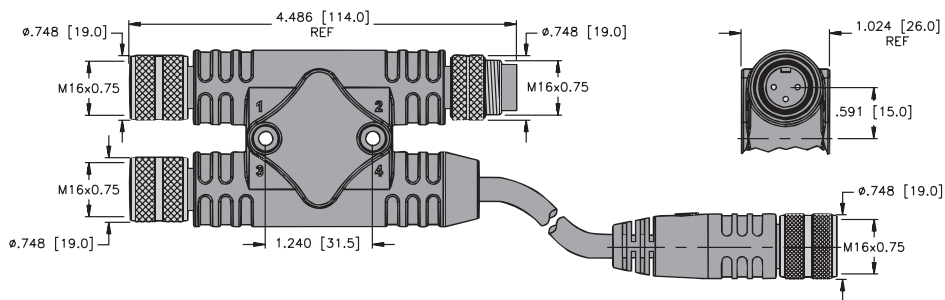

34

**Cable Trunk and Cable Drop with M16 Power Connectors, Trunk #2 Male
BH-BKM/BSM/2BKM..**

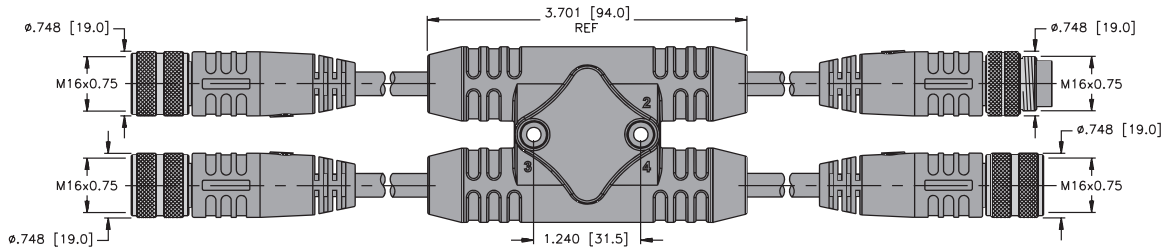

M16 Powerfast Tee Wiring Diagrams

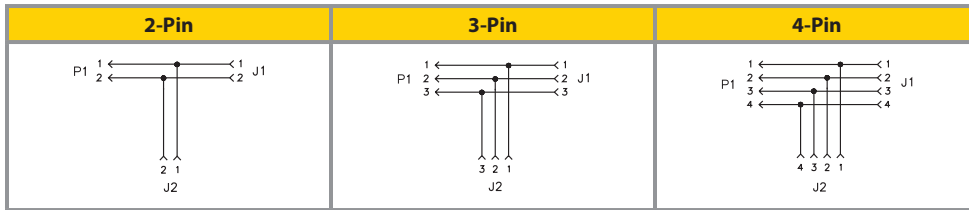

M16 Powerfast h-Style Tee Wiring Diagrams

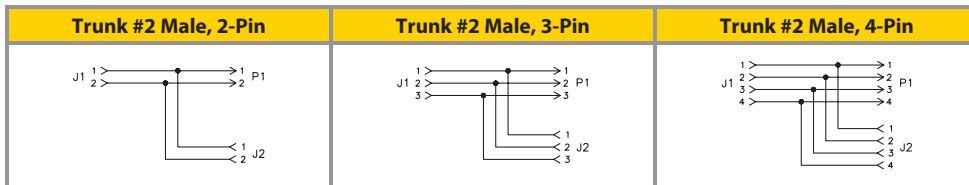
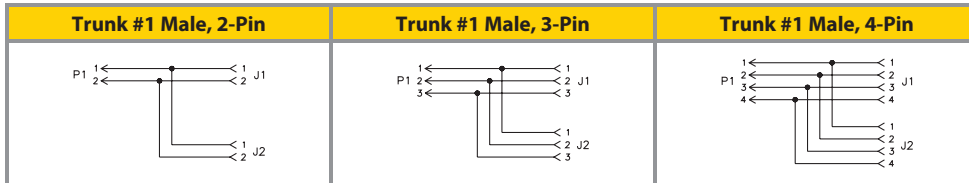

M16 Powerfast H-Style Tee Wiring Diagrams

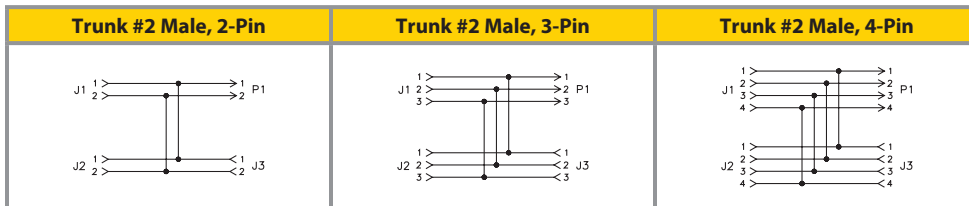
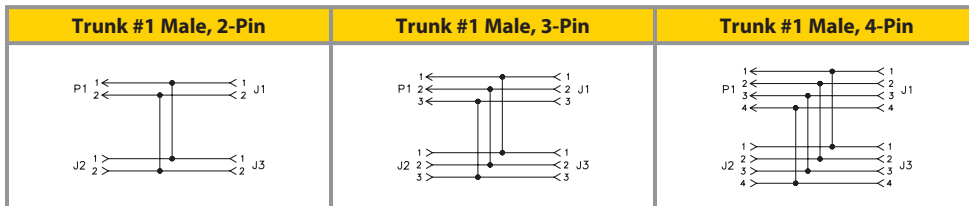

M16 Powerfast Tee Pinouts

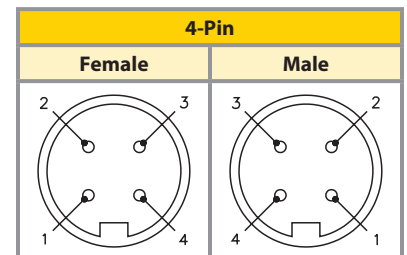
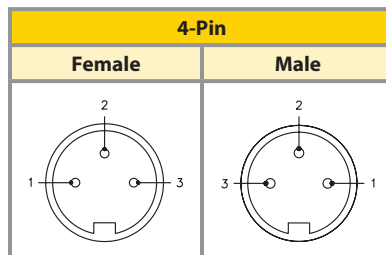
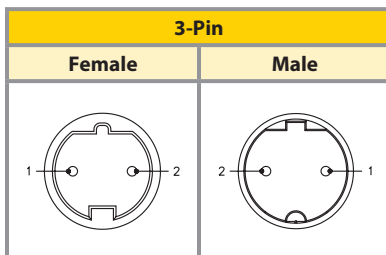

M16 Powerfast Closure Cap Selection Matrix

		35	36	37	38	39	40
		Mates to male cordsets and receptacles	Mates to female cordsets and receptacles	Mates to male receptacles	Mates to female receptacles	Mates to male cordsets and receptacles	Mates to female cordsets and receptacles
Material	Thread	6" SS Loop Lanyard	6" SS Loop Lanyard	6" SS Lanyard with Eyelet	6" SS Lanyard with Eyelet	No Lanyard	No Lanyard
Nickel Plated Brass	M16	BKM-CC	BSM-CC	BKF-CC	BSK-CC	BKM-MC	BSM-MC

See table below for dimensional drawings.

M16 Powerfast Closure Cap Dimensions

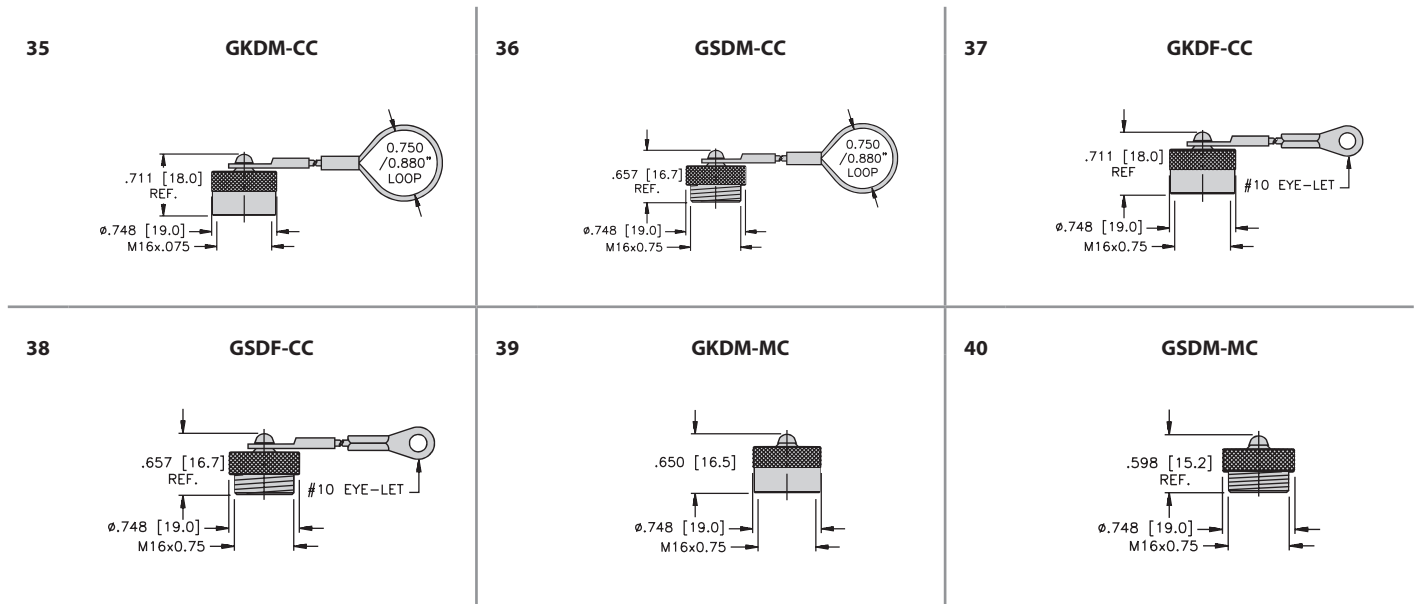

M16 Powerlok

Part Number	Application
LOCK-M16	Nylon locking guard for straight M16 Powerfast connectors
LOCK-M16-TEE	

M16 Powerlok Open



M16 Powerlok Closed



Part Number Keys	J44
Cordset and Receptacle Specifications	J45
Cordset and Receptacle Selection Matrix	J46
Cordset and Receptacle Dimensions	J47
Cordset and Receptacle Pinouts	J48

M23 powerfast

Features

- Options for combination of power and signal wires in one cable
- Shielded versions available
- 6 to 9-pin
- 12 to 14 AWG conductors for power, 18 AWG conductors for signal
- Up to 30 Amp, 600 Volt rated for power
- Up to 8 Amp, 300 Volt rated for signal
- AWM or tray rated-exposed run PVC cable
- IEC IP67 protection



M23 Powerfast Cordset Part Number Key

Part Number Keys are to assist in IDENTIFICATION ONLY. Consult factory for catalog items not identified.

M23 (23 mm) Powerfast Cordset	B S M	34-198	-	*	/S..
Gender					Varieties
K = female contact holder, female threads					(blank) = PVC jacket
S = male contact holder, female threads					/S90 = PUR jacket
SS = male contact holder, male threads					Length in Meters
Configuration					Number of Wires / AWG / Color Codes
M = straight					64-078 = 6x14 AWG WH, RD, GN, OG, BK, BU
WM = right angle					74-079 = 7x14 AWG WH/BK, BK, WH, RD, OG, BU, GN
(blank) = straight assembled connector					94-080 = 3x14 & 6X18 AWG RD, WH, WH/BK, BU, OG, BK, GN/BK, GN, RD/BK
Coupling Nut Material					622-059 = 6x12 AWG BU, RD, GN, BN, OG, YE
(blank) = nickel plated brass					822-287 = 4x12 & 4X18 AWG BU, GN, WH, BK, OG, RD, WH/BK, RD/BK
V = stainless steel					622-286 = 6x12 AWG BU, RD, GN, BN, OG, YE
S = shielded					822-288 = 4x12 & 4X18 AWG BU, GN, WH, BK, OG, RD, WH/BK, RD/BK
					Insertion Point of Extension Cable Second Prefix*
					* Male connector listed first, female connector second
					Example: <u>CSM CKM 64-078-1</u>

Extension Examples

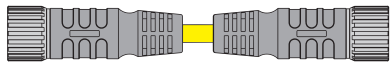

C K M

C K M

74-079 - ***** **/S..**

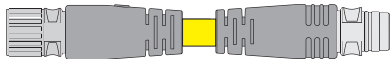

C SS M

C K M

622-059 - ***** **/S..**

M23 Powerfast Receptacle Part Number Key

M23 (23 mm) Powerfast Cordset	C K F	64-6	-	*	/M20
Gender					Connection Thread
K = female contact holder, male threads					/M20 = M20x1.5 threads
S = male contact holder, male threads					Length in Meters
Designator for Receptacle					Number of Wires / AWG / Color Codes
					64-6 = 6x14 AWG WH, RD, GN, OG, BK, BU
					74-7 = 7x14 AWG WH/BK, BK, WH, RD, OG, BU, GN
					94-9 = 3x14 & 6X18 AWG RD, WH, WH/BK, BU, OG, BK, GN/BK, GN, RD/BK
					622-6 = 6x12 AWG BU, RD, GN, BN, OG, YE
					822-8 = 4x12 & 4X18 AWG BU, GN, WH, BK, OG, RD, WH/BK, RD/BK
					Number of Wires / AWG / Color Codes
					(blank) = front mount
					D = rear mount
					F = flange
					MF = flange, rotating coupling nut
					L = front mount, long threads

M23 Powerfast Single Keyway Cordset Specifications

Mechanical

Mold material/color:	PUR/Black
Contact carrier material:	Nylon or PBT
Coupling nut material:	
Standard:	Nickel plated brass
Additional options:	316 stainless steel
Environmental protection:	IEC IP67
Temperature rating:	-40 °C to +105 °C (-40 °F to +221 °F)

Electrical

Contact material:	Brass with gold plating
Cable jacket material/color:	PVC/Yellow
Ratings:	
Power:	20 Amps, 300 V
Signal:	8 Amps, 150 V

M23 Powerfast 3-Key Cordset Specifications

Mechanical

Mold material/color:	PUR/Black
Contact carrier material:	Nylon or PBT
Coupling nut material:	
Standard:	Nickel plated brass
Environmental protection:	IEC IP67
Temperature rating:	-40 °C to +90 °C (-40 °F to +194 °F)

Electrical

Contact material:	Brass with gold plating
Cable jacket material/color:	TC-ER PVC/Yellow
Ratings:	
Power:	30 Amps, 600 V
Signal:	9 Amps, 300 V

M23 Powerfast Single Keyway Receptacle Specifications

Mechanical

Contact carrier material:	Nylon or PBT
Housing material/plating:	
Standard:	Nickel plated brass
Additional options:	316 stainless steel
Environmental protection:	IEC IP67
Temperature rating:	-30 to +90 °C (-40 °F to +194 °F)

Electrical

Contact material:	Brass with gold plating
Conductor insulation:	PVC
Ratings:	
Power:	20 Amps, 300 V
Signal:	8 Amps, 150 V

M23 Powerfast 3-Key Receptacle Specifications

Mechanical

Contact carrier material:	Nylon or PBT
Housing material/plating:	
Standard:	Zinc die-cast, chromated
Environmental protection:	IEC IP67
Temperature rating:	-30 to +80 °C (-40 °F to +176 °F)



Electrical

Contact material:	Brass with gold plating
Conductor insulation:	PVC
Ratings:	
Power:	30 Amps, 600 V
Signal:	9 Amps, 300 V





We reserve the right to make technical alterations without prior notice.

M23 powerfast

M23 Powerfast Single Keyway Cordset Selection Matrix





			1 	2 	3 
			Straight Female	Straight Male	Straight Male
Pins	AWG	Current Rating	Single Keyway	Single Keyway	Single Keyway
6	14	20 Amps	CKM 64-078-*	CSM 64-078-*	CSSM 64-078-*
7	14	20 Amps	CKM 74-079-*	CSM 74-079-*	CSSM 74-079-*
9	3x14; 6x18	8 Amps (1-3,5,7,9), 20 Amps (4,6,8)	CKM 94-080-*	CSM 94-080-*	CSSM 94-080-*

M23 Powerfast 3-Key Cordset Selection Matrix





			4 	5 	6 	7 
			Straight Female	Straight Male	Right Angle Female	Right Angle Male
Pins	AWG	Current Rating	3-Key	3-Key	3-Key	3-Key
6	12	30 Amps	CKM 622-059-*	CSSM 622-059-*	CKWM 622-059-*	CSSWM 622-059-*
8	4x12; 4x18	9 Amps (A-D), 30 Amps (1-4)	CKM 822-287-*	CSSM 822-287-*	CKWM 822-287-*	CSSWM 822-287-*

Pins	AWG	Current Rating	Shielded 3-Key	Shielded 3-Key	Shielded 3-Key	Shielded 3-Key
6	12	30 Amps	CKMS 622-286-*	CSSMS 622-286-*	CKWMS 622-286-*	CSSWMS 622-286-*
8	4x12; 4x18	9 Amps (A-D), 30 Amps (1-4)	CKMS 822-288-*	CSSMS 822-288-*	CKWMS 822-288-*	CSSWMS 822-288-*

M23 Powerfast Single Keyway Receptacle Selection Matrix

			8 	9 	10 	11 
			Female	Male	Female	Male
Pins	AWG	Current Rating	M20 Mount, Standard Thread	M20 Mount, Standard Thread	M20 Mounting, Long Thread	M20 Mounting, Long Thread
6	14	20 Amps	CKF 64-6-*	CSF 64-6-*	CKFL 64-6-*	CSFL 64-6-*
7	14	20 Amps	CKF 74-7-*	CSF 74-7-*	CKFL 74-7-*	CSFL 74-7-*
9	3x14; 6x18	8 Amps (1-3,5,7,9), 20 Amps (4,6,8)	CKF 94-9-*	CSF 94-9-*	CKFL 94-9-*	CSFL 94-9-*

M23 Powerfast 3-Key Receptacle Selection Matrix

			12 	13 	14 	15 
			Female	Male	Female	Male
Pins	AWG	Current Rating	Flange Mount	Flange Mount	M20 Mounting Thread	M20 Mounting Thread
6	12	30 Amps	CKFMF 622-6-*	CSFF 622-6-*	CKFMF 622-6-*/M20	CSFF 622-6-*/M20
8	4x12; 4x18	9 Amps (A-D), 30 Amps (1-4)	CKFMF 822-8-*	CSFF 822-8-*	CKFMF 822-8-*/M20	CSFF 822-8-*/M20

See pages 47-48 for dimensional drawings.

* Length in meters. Standard cable lengths are 2, 5 and 10 meters. Standard lead length is 0.5 meters. Consult factory for other lengths.

Note: Extension cables are available, please consult Part Number Key (page 42).

Standard coupling nut and housing material is nickel plated brass. Consult Part Number Key (page 42) for 316 stainless steel options.

We reserve the right to make technical alterations without prior notice.

M23 Powerfast Single Keyway Cordset Dimensions

1 & 2

CKM (CSM)..

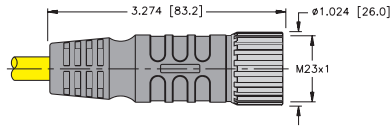

3

CSSM..

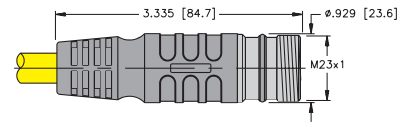

M23 Powerfast 3-Key Cordset Dimensions

4

CKM..

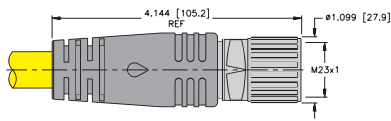

5

CSSM..

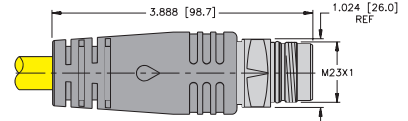

6

CKWM..

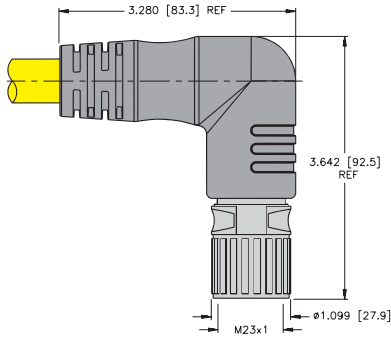

7

CSSWM..

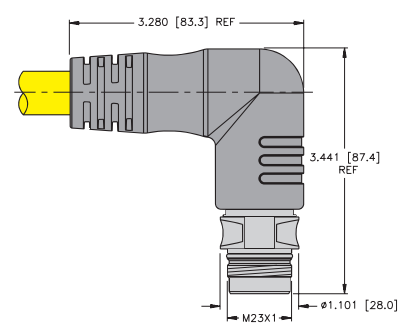

M23 powerfast

M23 Powerfast Single Keyway Receptacle Dimensions

8 & 9

CKF (CSF)..

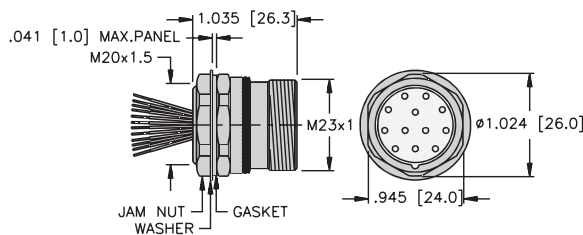

10 & 11

CKFL (CSFL) ..

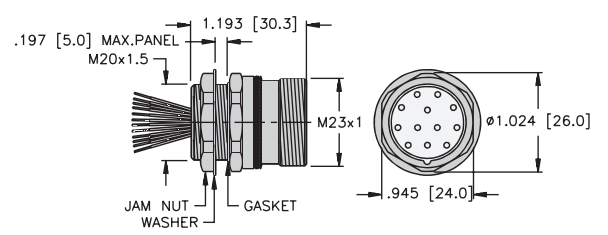

M23 Powerfast 3-Key Receptacle Dimensions

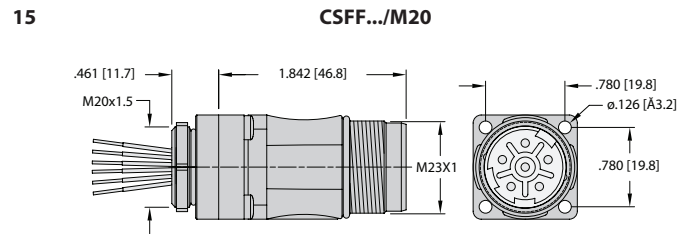
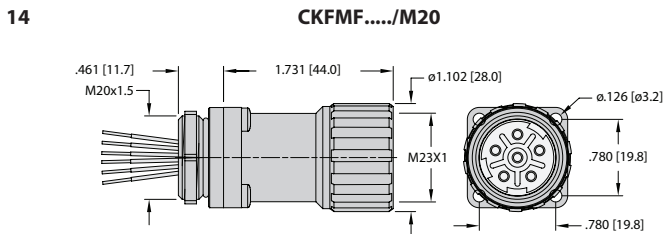
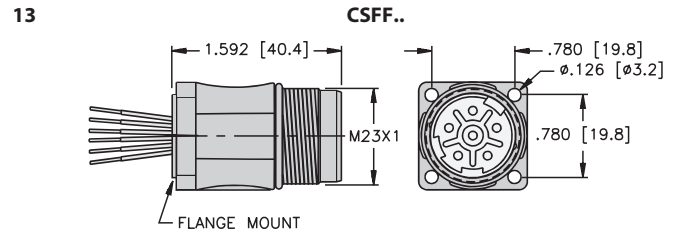
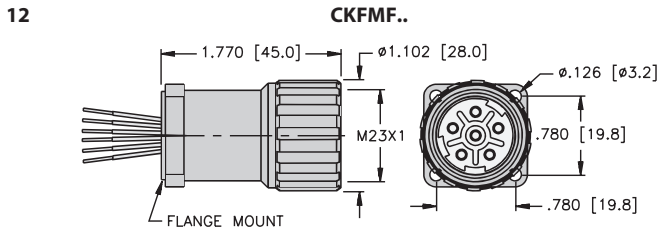

M23 Powerfast Single Keyway Cordset and Receptacle Pinouts

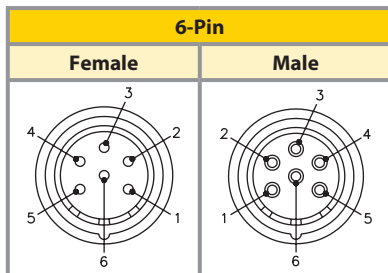

- Pinouts**
1. WH
 2. RD
 3. GN
 4. OG
 5. BK
 6. BU

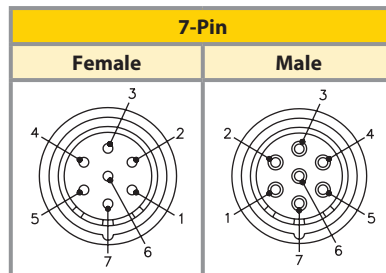

- Pinouts**
1. WH/BK
 2. BK
 3. WH
 4. RD
 5. OG
 6. BU
 7. GN

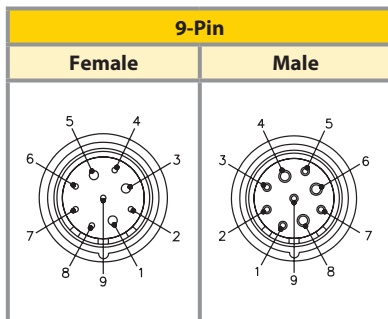

- Pinouts**
1. RD
 2. WH
 3. WH/BK
 4. BU
 5. OG
 6. BK
 7. GN/BK
 8. GN
 9. RD/BK

M23 Powerfast 3-Key Cordset and Receptacle Pinouts

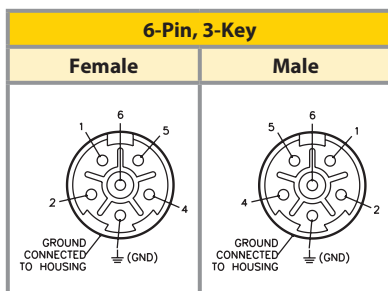

- Pinouts**
1. BU
 2. RD
 3. GN
 4. BN
 5. OG
 6. YE

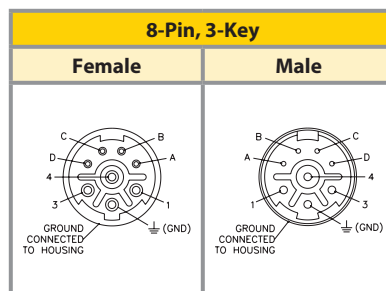

- Pinouts**
1. BU
 2. GN
 3. WH
 4. BK
 - A. OG
 - B. RD
 - C. WH/BK
 - D. RD/BK

Part Number Keys	J50
Cordset and Receptacle Specifications	J51
Cordset and Receptacle Selection Matrix	J51
Cordset and Receptacle Dimensions	J52
Cordset and Receptacle Pinouts	J52
h-Style Tee, Jumper Plug and Extension Specifications	J53
h-Style Tee, Jumper Plug and Extension Matrix	J54
h-Style Tee, Jumper Plug and Extension Dimensions	J55
h-Style Tee, Jumper Plug and Extension Pinouts	J55

Features

- Options for combination of power & signal wires in one cable
- 8 AWG conductors for power
- 14 AWG and 18 AWG conductor options for signal
- Up to 35 Amp, 250 and 600 volt rated



M40 Powerfast Cordset Part Number Key

Part Number Keys are to assist in IDENTIFICATION ONLY. Consult factory for catalog items not identified.

H S M	4 8 0 0	- 1279	- *	/S..
--------------	----------------	---------------	------------	-------------

M40 Powerfast Cordset

Gender
 K = female connector, female threads
 S = male connector, male threads

M = molded connector
 (blank) = assembled connector

Shielding
 S = shield tied to coupling nut

Housing Material
 (blank) = nickel plated brass

Insertion Point for Second Connector*
 * Male connector listed first, female connector second
 Example: **HSM HKM 4800-1279-5**

Number of Power Wires
 4 = 4 wires connected to power pins
 3 = 3 wires connected to power pins

Varieties
 /S... = consult factory
 /CS... = consult factory

Length in Meters

Color Codes / Cable Type
 1279 = WH, BK, RD, GN, TC-ER TPE Black
 1313 = WH, BK, RD, GN, TC-ER TPE Yellow
 1314 = WH, BK, RD, GN, BK, WH, BN, BU, TC-ER TPE Black
 1884 = BK"V", BK"U", BK"W". BU/YE"+", BU/YE"-", GN/YE, TC-ER/STOOW, PVC Black

Gauge of Control Wires
 0 = no connection or 20 AWG wire to control wins
 4 = 14 AWG Wire to control pins
 6 = 16 AWG wire to control pins
 8 = 18 AWG wire to control pins

Color Codes / Cable Type
 0 = no connection to control pins
 2 = 2 control pins connected
 4 = 4 control pins connected

Color Codes / Cable Type
 8 = 8 AWG wire to power pins
 0 = 10 AWG wire to power pins

Extension Examples

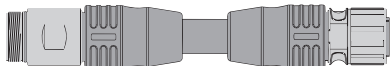

H S M **H K M** **4 8 0 0** - **1279** - ***** /S..

M23 Powerfast Receptacle Part Number Key

H S F F	4 8 0 0	- *	/S..
----------------	----------------	------------	-------------

M40 Powerfast Receptacle

Gender
 K = female connector, female threads
 S = male connector, male threads

Designator for Receptacles

Mounting Style
 F = flange
 MF = flange, rotating coupling nut

Number of Power Wires
 4 = 4 wires connected to power pins
 3 = 3 wires connected to power pins

Varieties
 /S... = consult factory
 /CS... = consult factory

Length in Meters

Gauge of Control Wires
 0 = no connection or 20 AWG wire to control pins
 4 = 14 AWG wire to control pins
 6 = 16 AWG wire to control pins
 8 = 18 AWG wire to control pins

Number of Control Wires
 0 = no connection to control pins
 2 = 2 control pins connected
 4 = 4 control pins connected

Gauge of Power Wires
 8 = 8 AWG wire to power pins
 0 = 10 AWG wire to power pins

M40 Powerfast Cordset Specifications

Mechanical

Mold material/color:	Polyamide/Black
Contact carrier material:	Nylon
Coupling nut material	Nickel plated brass
Environmental protection:	IEC IP67
Temperature rating:	-40 °C to +90 °C (-40 °F to +194 °F)

Electrical

Contact material:	Brass or copper with gold plating
Cable jacket material/color:	TC-ER PVC
Ratings:	
Power:	35 Amps, 600 VAC
Signal:	4-9 Amps, 250 VAC



M40 Powerfast Receptacle Specifications

Mechanical

Contact carrier material:	Nylon
Housing material/plating:	Nickel plated brass
Environmental protection:	IEC IP67
Temperature rating:	-40 °C to +105 °C (-40 °F to +221 °F)

Electrical

Contact material:	Brass or copper with gold plating
Conductor insulation:	PVC
Ratings:	
Power:	35 Amps, 600 VAC
Signal:	4-9 Amps, 250 VAC



M40 Powerfast Cordset Selection Matrix

Front Mount			1	2	3	4
Pins	AWG	Current Rating	Straight Female	Straight Male	Right Angle Female	Right Angle Male
4	8	35 Amps	HKM 4800-1279-*	HSM 4800-1279-*	HKWM 4800-1279-*	HSWM 4800-1279-*
6	4x8; 2x14	35 Amps (8 AWG), 9 Amps (14 AWG)	HKM 4824-1884-*	HSM 4824-1884-*	HKWM 4824-1884-*	HSWM 4824-1884-*
8	4x8; 4x18	35 Amps (8 AWG), 4 Amps (18 AWG)	HKM 4848-1314-*	HSM 4848-1314-*	HKWM 4848-1314-*	HSWM 4848-1314-*

M40 Powerfast Receptacle Selection Matrix

Front Mount			5	6
Pins	AWG	Current Rating	Female Flange Mount	Male Flange Mount
4	8	35 Amps	HKFMF 4800-*	HSFF 4800-*
6	4x8; 2x14	35 Amps (8 AWG), 9 Amps (14 AWG)	HKFMF 4824-*	HSFF 4824-*
8	4x8; 4x18	35 Amps (8 AWG), 4 Amps (18 AWG)	HKFMF 4848-*	HSFF 4848-*

We reserve the right to make technical alterations without prior notice.

M40 powerfast

M40 Powerfast Cordset and Receptacle Dimensions

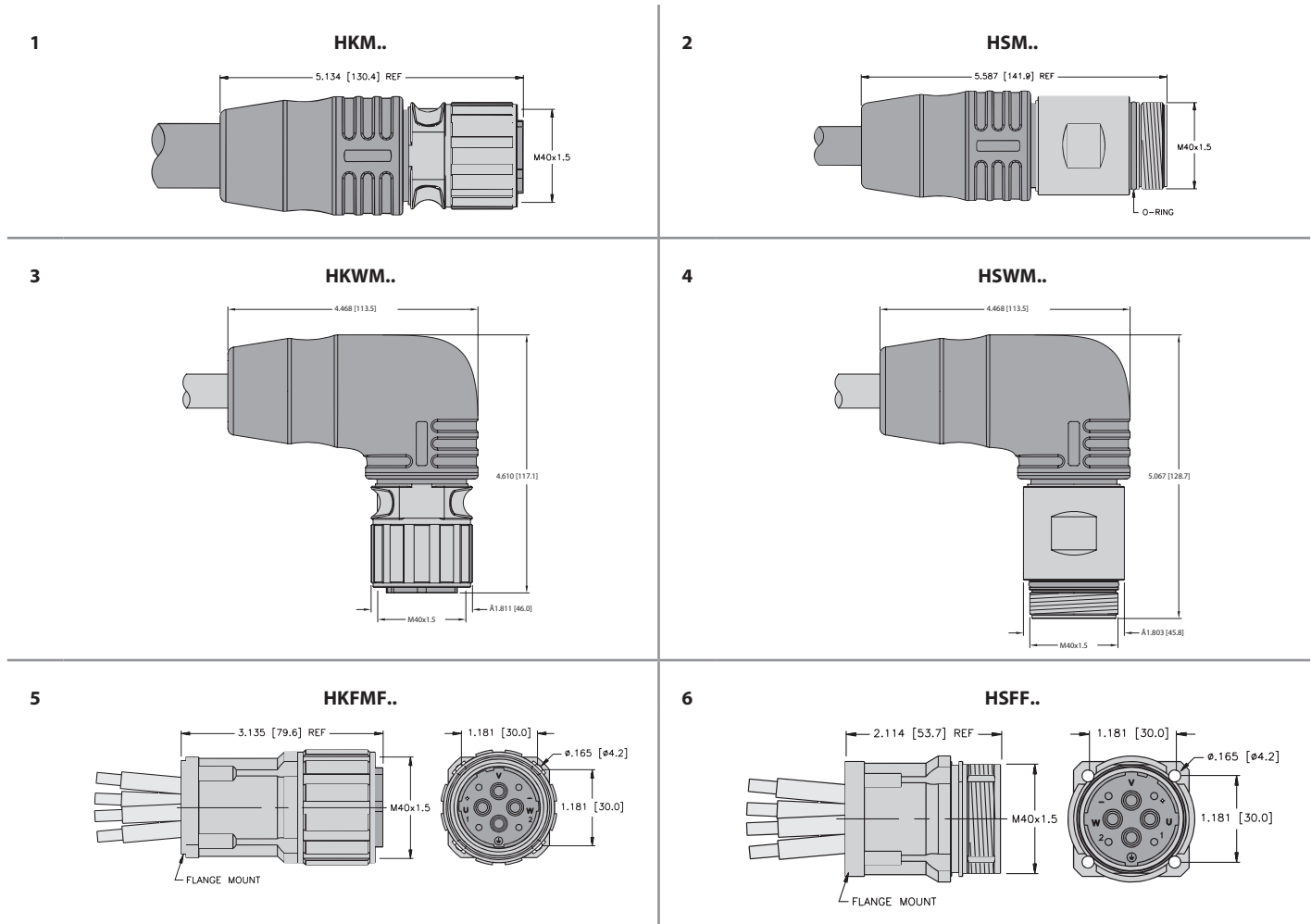

M40 Powerfast Cordset and Receptacle Pinouts

4-Pin		Pinouts	6-Pin		Pinouts
Female	Male		Female	Male	
		V. WH U. BK W. RD \pm . GN +. N/C -. N/C 1. N/C 2. N/C			V. Black V U. Black U W. Black W \pm . GN/YE +. BU/YE "+" -. BU/YE "-"
			V. WH U. BK W. RD \pm . GN +. BK -. BU 1. WH 2. BN		

M40 Powerfast h-Style Tee Specifications

Mechanical

Mold material/color:	Polyamide/Black
Contact carrier material:	Nylon
Coupling nut material	Nickel plated brass
Environmental protection:	IEC IP67
Temperature rating:	-40 °C to +90 °C (-40 °F to +194 °F)

Electrical

Contact material:	Brass or copper with gold plating
Ratings:	
Power:	35 Amps, 600 VAC
Signal:	9 Amps, 250 VAC



M40 Powerfast Jumper Plug Specifications

Mechanical

Mold material/color:	Polyamide/Black
Contact carrier material:	Nylon
Coupling nut material	Nickel plated brass
Environmental protection:	IEC IP67
Temperature rating:	-40 °C to +90 °C (-40 °F to +194 °F)

Electrical

Contact material:	Brass or copper with gold plating
Ratings:	
Power:	35 Amps, 600 VAC
Signal:	9 Amps, 250 VAC



M40 Powerfast to Harting Connector Specifications

Mechanical

Mold material/color:	
M40 connector:	Polyamide/Black
Hood material/color:	
Harting connector:	Zinc die-cast/Black (Harting)
Contact carrier material:	
M40 connector:	Nylon
Harting connector:	Polycarbonate
Coupling nut material:	
M40 connector:	Nickel plated brass
Environmental protection:	
M40 connector:	IEC IP67
Harting connector:	IEC IP65
Temperature rating:	-40 °C to +90 °C (-40 °F to +194 °F)

Electrical

Contact material:	
M40 connector:	Brass or copper with gold plating
Harting connector:	Copper alloy with gold over silver plating
Cable jacket material:	
Standard:	TC-ER STOOW PVC
Additional options:	TC-ER PVC (/S4000 version)
Ratings:	20 Amps, 600 VAC

We reserve the right to make technical alterations without prior notice.

M40 powerfast

M40 Powerfast h-Style Tee Selection Matrix



Pins	Drop AWG	Trunk Current Rating	Drop Current Rating	Integral M40 Connector Drop
6	4x8; 2x14	35 Amps (8 AWG), 6 Amps (14 AWG)	35 Amps (8 AWG), 9 Amps (14 AWG)	SH-HSM/2 HKM 4824

M40 Powerfast Jumper Plug Selection Matrix



Pins	AWG	Current Rating	Male
6	4x8; 2x14	35 Amps (8 AWG), 9 Amps (14 AWG)	HSM 4824/J+ -

M40 Powerfast to Harting Connector Selection Matrix



Pins	AWG	Current Rating	TC-ER	TC-ER STOOW
6	4x8; 2x14	20 Amps (12 AWG), 9 Amps (14 AWG)	HSM 40 HANQW4/2-1850-*/S4000	HSM 40 HANQW4/2-1668-*

We reserve the right to make technical alterations without prior notice.

M40 Powerfast h-Style Tee and Jumper Plug Receptacle Dimensions

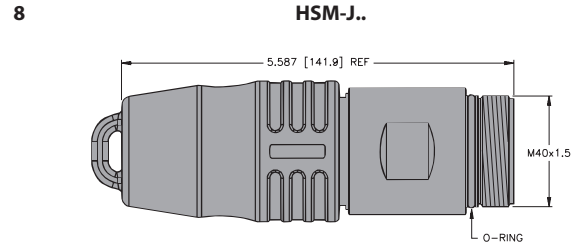
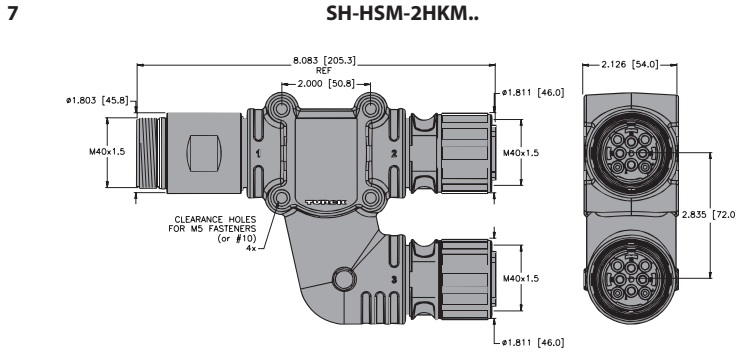

M40 Powerfast to Harting Receptacle Dimensions

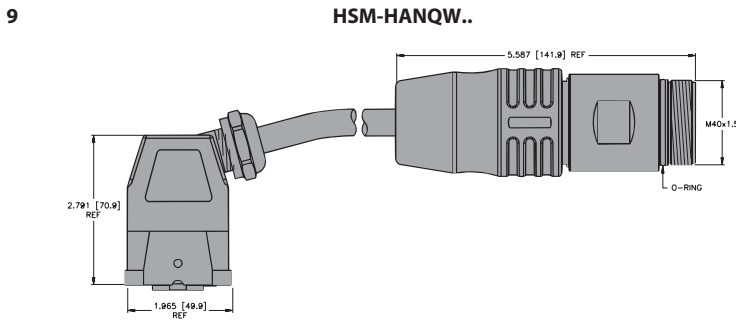

M40 Powerfast h-Style Wiring Diagram

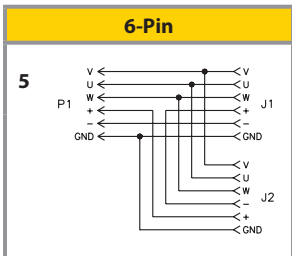

M40 Powerfast Jumper Plug and M40 Powerfast to Harting Connector Pinouts

6-Pin	Pinouts	6-Pin	Pinouts	6-Pin	Pinouts
Male		Male		Female	
6	V. N/C U. N/C W. N/C ±. N/C +. Jumper to "-" -. Jumper to "+"	7	1. RD 2. WH 3. BK ±. GN 4. N/C 11. N/C 12. N/C	7	U. RD V. WH W. BK ±. GN +. Jumper to "-" -. Jumper to "+"

Part Number Keys	K3
Cordsets	K6
Receptacles	K13
EtherNet/IP Cordsets	K16
Field Wireables	K23

Features

- CAT 5e rated cables
- 2 pair and 4 pair cable option
- 8-pin and 4-pin D-coded connectors
- M12 and RJ45 connectors
- Up to 4 Amp and 250 Volt rated
- IP67/IP69K rated



System Description

Ethernet is the most popular protocol used to connect office computers and peripherals today. It is increasingly finding its way into other applications, and is rapidly becoming the network of choice for higher level industrial control applications. Ethernet is primarily used to connect PLCs, computers, HMI displays and other high level components.

The term “Ethernet” actually refers to the lower level communication structure. Various different versions, or implementations, of Ethernet are available, such as EtherNet/IP™ and Modbus-TCP. It is important to note that while all of these different specifications use the same physical communication method and can operate on the same cable simultaneously, they cannot necessarily communicate with each other. For example, Modbus-TCP devices cannot communicate with EtherNet/IP devices. This is because the messages and communication protocol have been defined differently for these systems, even though the physical electrical structure is the same. Think of it as two people who speak different languages; they speak by moving air with their mouths, but the rules of the languages are different.

Turck’s BL67 Ethernet gateways provide a convenient way to connect industrial I/O devices directly to the Ethernet system, expediting monitoring and troubleshooting for the overall control scheme.

Typical System Configuration

Basic Parts List

A typical Ethernet system consists of the following parts:

- Controller
- Ethernet I/O modules
- Power supply
- Switches
- Ethernet cable

Ethernet I/O modules act as clients on a network. A server device is needed to retrieve data from and post data to the client. This is analogous to an office network, where the client PC on a user’s desk may actively connect with multiple servers to access information in different areas of the enterprise. Turck Ethernet stations are designed to be fully compatible with established Ethernet standards for industrial use.

Cordsets

Turck offers a complete line of molded Ethernet cordsets to facilitate network installation, resulting in a faster start-up and fewer wiring errors. Cables are available with stranded or solid-core conductors, with or without shielding.

Most Turck Ethernet equipment uses the 4 or 8-pin (M12) Eurofast® connector specifications. These connectors provide a tough, rugged seal, and are IP 67 rated. In some cases (mainly in the control cabinet) a traditional RJ45 Ethernet connector needs to be used. Turck provides RJ45 cordsets, as well as a variety of devices made to convert between RJ45 and Eurofast connectors. Turck cordsets for the Ethernet system are available in standard lengths. Please contact your local sales representative to order custom lengths.

Maximum Lengths Ratings

Ethernet allows different maximum cable lengths depending on the type of cable being used. An Ethernet segment may be as long as 100 m, with up to 90 m solid core cable and the remaining 10 m can be stranded patch cords.

Eurofast® Cordset Part Number Key

Part Number Keys are to assist in IDENTIFICATION ONLY. Consult factory for catalog items not identified.

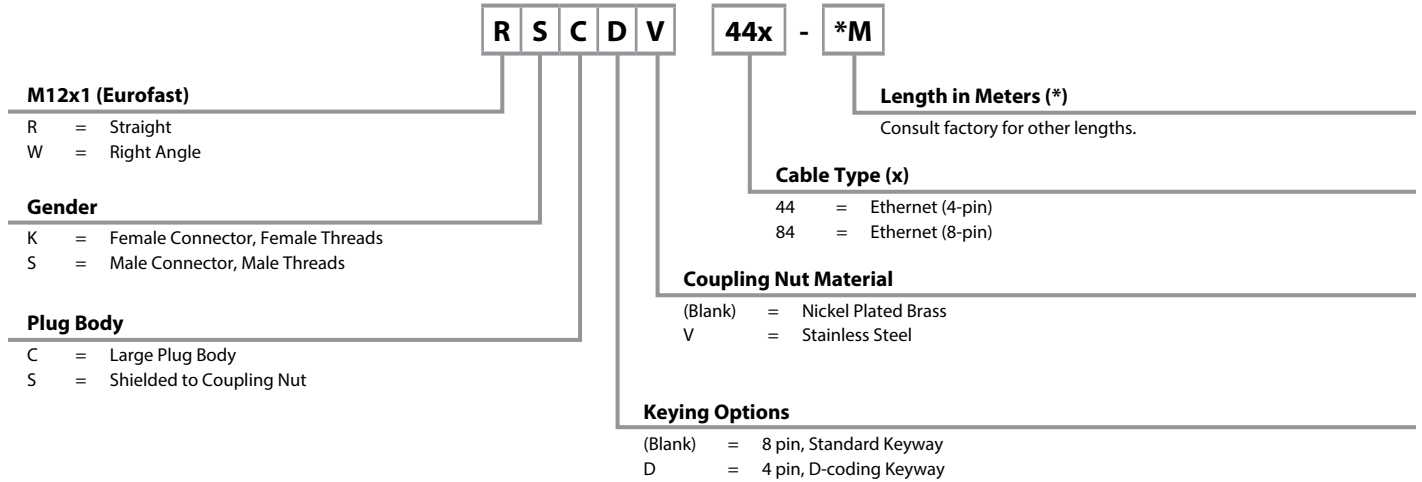

RJ45 Network Cordsets Part Number Key

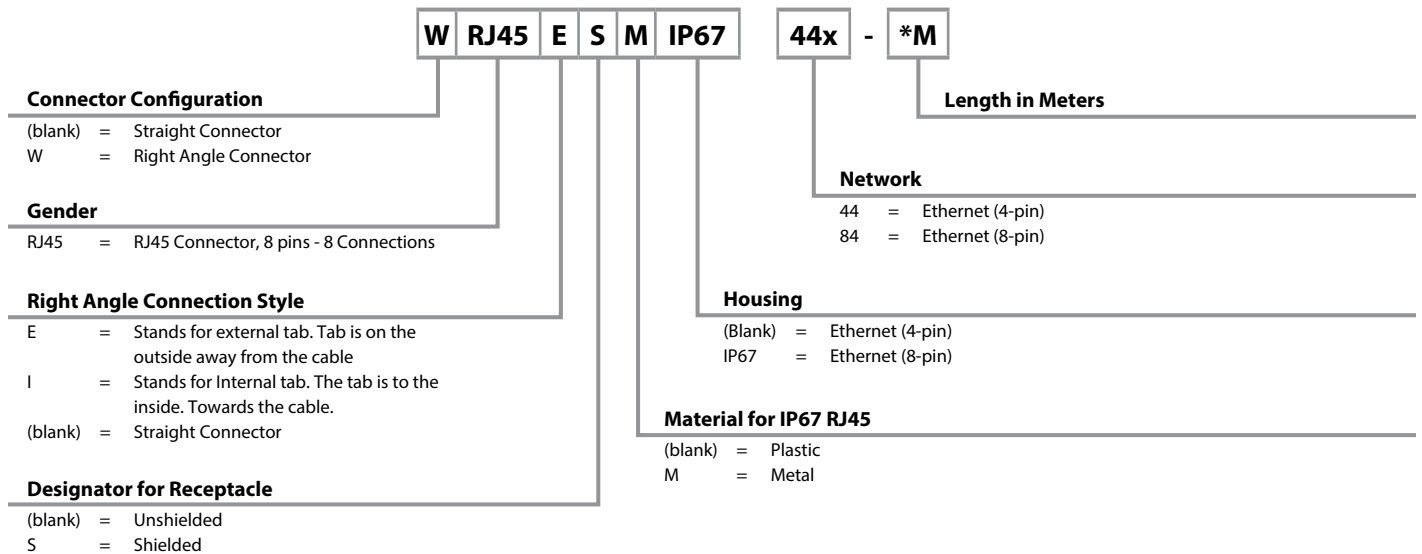

Ethernet Physical Media Connectivity

Eurofast® Receptacle Part Number Key

Part Number Keys are to assist in IDENTIFICATION ONLY. Consult factory for catalog items not identified.

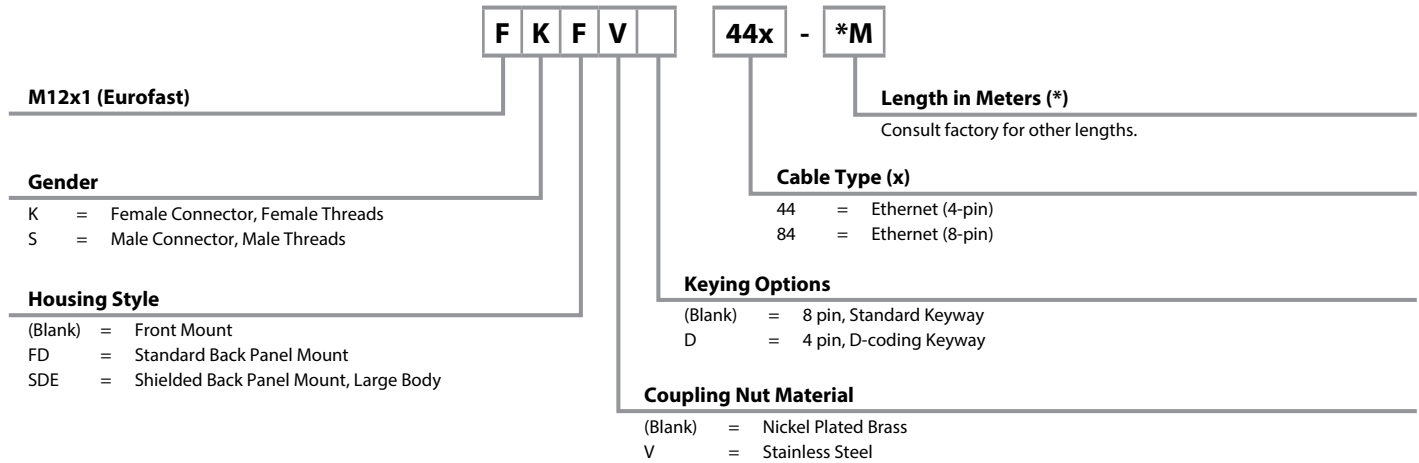

Ethernet, Cable Specifications, 8-wire

- Cable that meets the requirements of TIA/EIA568-C.2 Category 5e Cable for 10 and 100 Base-T Ethernet
- Cable is UL Rated for Sunlight and Oil Resistant



We reserve the right to make technical alterations without prior notice.

Type	Approvals	Data Pair		Outer Jacket Material Color Nominal O.D.	Shields Type	Bulk Cable Part Number / Weight/300 M	Flexlife Ratings
		AWG Color Code	DCR (/1000 feet) Insulation				
840 80 °C, 600 V	c(UL)us Type CM AWM	4UTPx24 AWG Stranded	26.5 Ohms PE	TPE Teal 6.3 mm (.118 in)	-	RB51460-*M 29 lbs. Flexlife®	10xO.D. 1 million cycles 20xO.D. 10 million cycles
841 80 °C, 600 V	c(UL)us Type CM AWM	4UTPx24 AWG Stranded	26.5 Ohms PE	TPE Teal 7.7 mm (.303 in)	Foil/Braid	RB50893-*M 43 lbs. Flexlife	10xO.D. 1 million cycles 20xO.D. 10 million cycles
842 75 °C, 300 V	c(UL)us Type CM AWM	4UTPx24 AWG Solid	31.5 Ohms PE	TPE Teal 6.1 mm (.240 in)	-	RB51462-*M 26 lbs.	-
843 80 °C, 600 V	c(UL)us Type CM AWM	4UTPx24 AWG Solid	28.6 Ohms PE	TPE Teal 7.3 mm (.287 in)	Foil/Braid	RB51463-*M 41 lbs.	-
849A AWM 444 75 °C, 300 V	NEC CM IAA CMG, FT4	4UTPx24 AWG Solid	27.5 Ohms PO	PVC Black 14.1 mm (.555 in)	Foil/Braid Armor	RB51100-*M 100 lbs. Armorfast®	-

* Indicates length in meters.







Standard spool lengths are 30, 75, 100, 150, 200, 225, 300 meters. Consult factory for other lengths.

†† 1 million cycles at 1.5" bend radius.

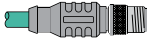
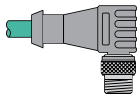
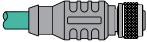
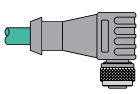
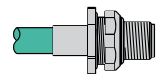
††† 2 million cycles at 2.5" bend radius.

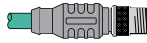
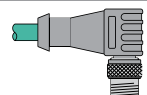
Ethernet Physical Media Connectivity

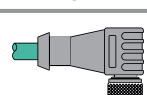
Ethernet, (M12x1) Eurofast®, RJ45, Cable/Cordset Selection Matrix - Unshielded

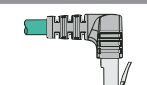
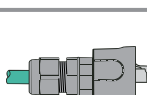
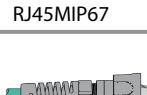
		Eurofast					
		Male		Female		Male	
		1 	2 	3 	4 	5 	
		RSC	WSC	RKC	WKC	FSFD	
		RSC 84x-*M	WSC 84x-*M	RKC 84x-*M	WKC 84x-*M	FSFD 84x-*M	
Bare							
Eurofast	Male	1 	RSC RSC 84x-*M	RSC WSC 84x-*M	RSC RKC 84x-*M	RSC WKC 84x-*M	RSC FSFD 84x-*M
		2 	WSC RSC 84x-*M	WSC WSC 84x-*M	WSC RKC 84x-*M	WSC WKC 84x-*M	WSC FSFD 84x-*M
	Female	3 			RKC RKC 84x-*M		RKC FSFD 84x-*M
		4 			RKC WKC 84x-*M	WKC WKC 84x-*M	WKC FSFD 84x-*M
RJ45	RJ45 Plug	9 					RJ45 FSFD 84x-*M
	WRJ45 Plug	10 					WRJ45E FSFD 84x-*M
	RJ45M IP67 Plug	11 					RJ45MIP67 FSFD 84x-*M
	RJ45 IP67 Plug	12 					RJ45IP67 FSFD 84x-*M



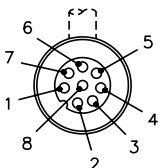
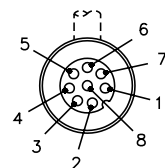

We reserve the right to make technical alterations without prior notice.

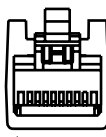
See pages K10 - K11 for dimensional drawings.

Eurofast	Pinouts	Eurofast
Male	1. White/Blue 2. White/Brown 3. Brown 4. Orange 5. White/Green 6. White/Orange 7. Blue 8. Green	Female
		

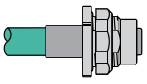
Standard Pinout	RJ45 Plug	(CR) Pinout
1. White/Orange 2. Orange 3. White/Green 4. Blue 5. White/Blue 6. Green 7. White/Brown 8. Brown	Male  12345678	1. White/Green 2. Green 3. White/Orange 4. Blue 5. White/Blue 6. Orange 7. White/Brown 8. Brown

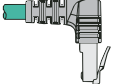
Ethernet, (M12x1) Eurofast®, RJ45, Cable/Cordset Selection Matrix - Unshielded

Eurofast	RJ45			
Female	RJ45 Plug	WRJ45 Plug	RJ45M IP67 Plug	RJ45 IP67 Plug
6  FKFD	9  RJ45	10  WRJ45E	11  RJ45MIP67	12  RJ45IP67
FKFD 84x-*M	RJ45 84x-*M	WRJ45E 84x-*M	RJ45MIP67 84x-*M	RJ45IP67 84x-*M
RSC FKFD 84x-*M	RSC RJ45 84x-*M	RSC WRJ45E 84x-*M	RSC RJ45MIP67 84x-*M	RSC RJ45IP67 84x-*M
WSC FKFD 84x-*M	WSC RJ45 84x-*M	WSC WRJ45E 84x-*M	WSC RJ45MIP67 84x-*M	WSC RJ45IP67 84x-*M
RKC FKFD 84x-*M	RKC RJ45 84x-*M	RKC WRJ45E 84x-*M	RKC RJ45MIP67 84x-*M	RKC RJ45IP67 84x-*M
WKC FKFD 84x-*M	WKC RJ45 84x-*M	WKC WRJ45E 84x-*M	WKC RJ45MIP67 84x-*M	WKC RJ45IP67 84x-*M
RJ45 FKFD 84x-*M	RJ45 RJ45 84x-*M		RJ45 RJ45MIP67 84x-*M	RJ45 RJ45IP67 84x-*M
WRJ45E FKFD 84x-*M	WRJ45E RJ45 84x-*M	WRJ45E WRJ45E 84x-*M	WRJ45 RJ45MIP67 84x-*M	WRJ45E RJ45IP67 84x-*M
RJ45MIP67 FKFD 84x-*M			RJ45MIP67 RJ45MIP67 84x-*M	RJ45MIP67 RJ45IP67 84x-*M
RJ45IP67 FKFD 84x-*M			RJ45IP67 RJ45MIP67 84x-*M	RJ45IP67 RJ45IP67 84x-*M

See pages K10 - K11 for dimensional drawings.

* Indicates length in meters.

x Indicates cable type.

Standard cable lengths are 1, 2, 4, 6, 8, 10, 15, and in +5 meter increments from there. Consult factory for other lengths.

For stainless steel coupling nuts change part number RSC ... to RSCV, FKFD ... to FKFDV.

For cross-over cable, add "CR" to part number RJ45 RJ45 CR 84x-*M.







For right angle RJ45, select WRJ45I for internal tab or WRJ45E for external tab.

We reserve the right to make technical alterations without prior notice.

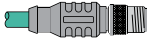
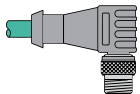
Ethernet Media

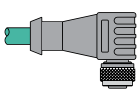
Ethernet Physical Media Connectivity

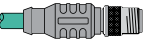
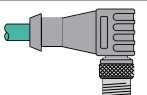
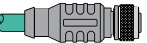
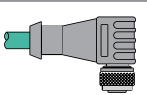
Ethernet, (M12x1) Eurofast®, RJ45, Cable/Cordset Selection Matrix - Shielded

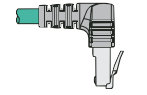
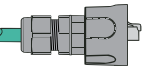
		Eurofast				
		Male		Female		
		1 	2 	3 	4 	
		RSS	WSS	RKS	WKS	
		RSS 84x-*M	WSS 84x-*M	RKS 84x-*M	WKS 84x-*M	
Bare						
Eurofast	Male	1 	RSS RSS 84x-*M	RSS WSS 84x-*M	RSS RKS 84x-*M	RSS WKS 84x-*M
		2 	WSS RSS 84x-*M	WSS WSS 84x-*M	WSS RKS 84x-*M	WSS WKS 84x-*M
	Female	3 			RKS RKS 84x-*M	
		4 			WKS RKS 84x-*M	WKS WKS 84x-*M
RJ45	RJ45 Plug	9 				
	WRJ45 Plug	10 				
	RJ45M IP67 Plug	11 				
		RJ45S				
		WRJ45ES				
		RJ45SMIP67				



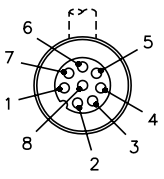
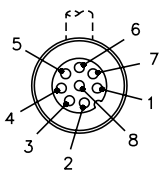

We reserve the right to make technical alterations without prior notice.

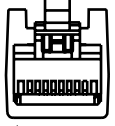
See pages K10 - K11 for dimensional drawings.

Eurofast	Pinouts	Eurofast
Male	1. White/Blue 2. White/Brown 3. Brown 4. Orange 5. White/Green 6. White/Orange 7. Blue 8. Green	Female
		

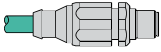
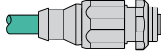
Standard Pinout	RJ45 Plug	(CR) Pinout
1. White/Orange 2. Orange 3. White/Green 4. Blue 5. White/Blue 6. Green 7. White/Brown 8. Brown	Male	1. White/Green 2. Green 3. White/Orange 4. Blue 5. White/Blue 6. Orange 7. White/Brown 8. Brown
	 12345678	

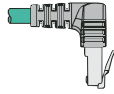
Ethernet, (M12x1) Eurofast®, RJ45, Cable/Cordset Selection Matrix - Shielded

Eurofast		RJ45		
Male	Female	RJ45 Plug	WRJ45 Plug	RJ45M IP67 Plug
7  FSSDE	8  FKSDE	9  RJ45S	10  WRJ45ES	11  RJ45SMIP67
FSSDE 84x-*M	FKSDE 84x-*M	RJ45S 84x-*M	WRJ45ES 84x-*M	RJ45SMIP67 84x-*M
RSS FSSDE 84x-*M	RSS FKSDE 84x-*M	RSS RJ45S 84x-*M	RSS WRJ45ES 84x-*M	RSS RJ45SMIP67 84x-*M
WSS FSSDE 84x-*M	WSS FKSDE 84x-*M	WSS RJ45S 84x-*M	WRJ45ES 84x-*M	WSS RJ45SMIP67 84x-*M
RKSS FSSDE 84x-*M	RKS FKSDE 84x-*M	RKS RJ45S 84x-*M	RKS WRJ45ES 84x-*M	RKS RJ45SMIP67 84x-*M
WKS FSSDE 84x-*M	WKS FKSDE 84x-*M	WKS RJ45S 84x-*M	WKS WRJ45ES 84x-*M	WKS RJ45SMIP67 84x-*M
RJ45S FSSDE 84x-*M	RJ45S FKSDE 84x-*M	RJ45S RJ45S 84x-*M		RJ45SS RJ45SMIP67 84x-*M
WRJ45 FSSDE 84x-*M	WRJ45 FKSDE 84x-*M	WRJ45ES RJ45S 84x-*M	WRJ45ES WRJ45ES 84x-*M	WRJ45ES RJ45SMIP67 84x-*M
RJ45SMIP67 FSSDE 84x-*M	RJ45SMIP67 FKSDE 84x-*M			RJ45SMIP67 RJ45SMIP67 84x-*M

See pages K10 - K11 for dimensional drawings.

* Indicates length in meters.

x Indicates cable type.

Standard cable lengths are 1, 2, 4, 6, 8, 10, 15, and in +5 meter increments from there. Consult factory for other lengths.

For stainless steel coupling nuts change part number RSS ... to RSSV, FKSDE ... to FKSDEV.

For cross-over cable, add "CR" to part number RJ45S RJ45S CR 84x-*M.

For right angle RJ45, select WRJ45I for internal tab or WRJ45E for external tab.

We reserve the right to make technical alterations without prior notice.

Ethernet Media

Ethernet Physical Media Connectivity

Ethernet, Eurofast® Cordset Connector Dimensions / Configuration

Specifications

Overmold:	TPU	Protection:	NEMA 1, 3, 4, 6P and IEC IP 67
Coupling Nut:	Nickel Plated CuZn or Stainless Steel	Rated Voltage:	60 V
Contact Carrier:	TPU or POM (Nylon)	Rated Current:	2 A
Contacts:	Gold Plated CuZn	Ambient Temperature:	-40 °C to +80 °C (32 °F to +176 °F)

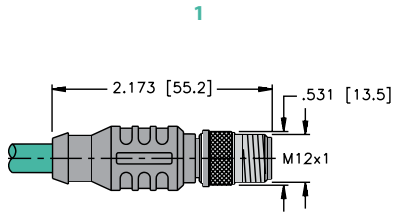

RSC/RSS ..

Page K6

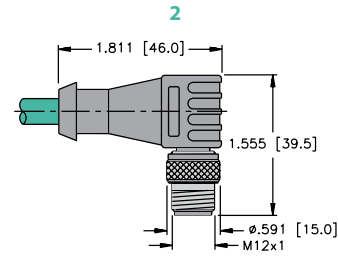

WSC/WSS ..

Page K6

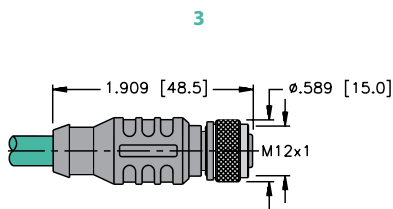

RKC/RKS ..

Page K6

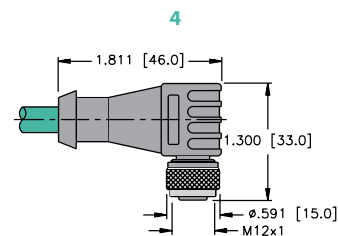

WKC/WKS ..

Page K6

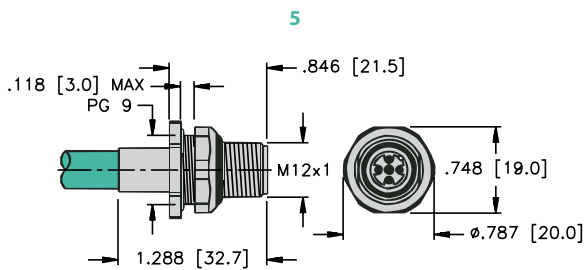

FSFD ..

Page K6

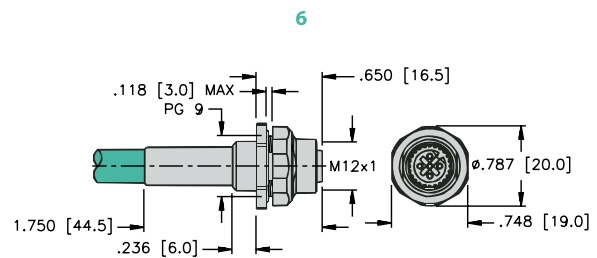

FKFD ..

Page K7

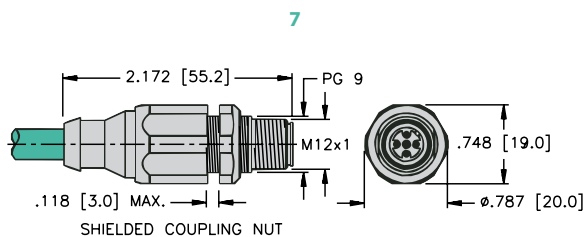

FSSDE ..

Page K9

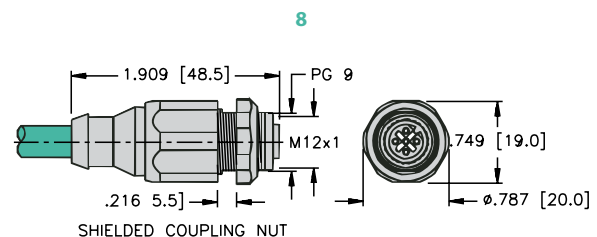

FKSDE ..

Page K9

We reserve the right to make technical alterations without prior notice.

Specifications

Overmold: TPU
Coupling Nut: Nickel Plated CuZn or Stainless Steel
Contact Carrier: TPU or POM (Nylon)
Contacts: Gold Plated CuZn

Protection: NEMA 1, 3, 4, 6P and IEC IP 67
Rated Voltage: 60 V
Rated Current: 2 A
Ambient Temperature: -40 °C to +75 °C (-22 °F to +167 °F)

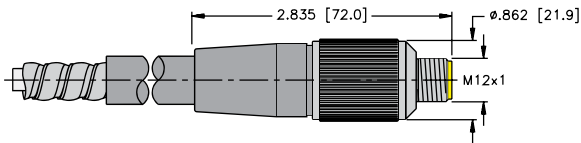

RSA ..

(Armorfast® only)

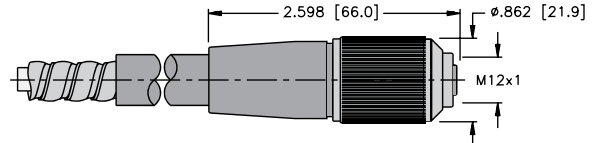

RKA ..

(Armorfast only)

Specifications

Overmold: TPU
Plug Material: Polycarbonate
Protection: NEMA 1 and IEC IP 20

Rated Voltage: 42 V
Rated Current: 1.5 A

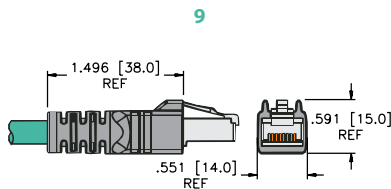

RJ45/RJ45S ..

Page K6

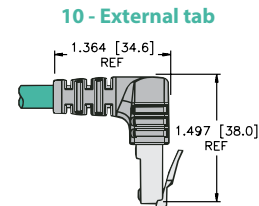

WRJ45E/WRJ45ES ..

External tab

Page K6

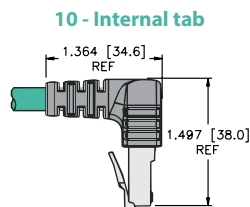

WRJ45I/WRJ45IS ..

Internal tab

Page K6

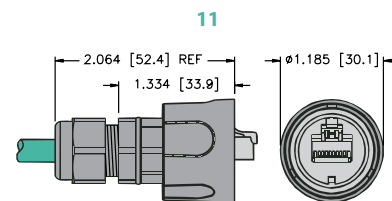

RJ45MIP67/RJ45SMIP67..

Page K6

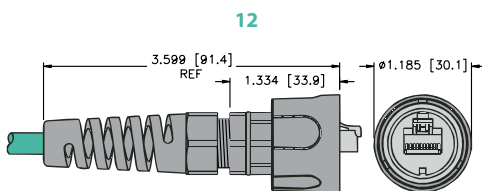

RJ45IP67 ..

Page K6

We reserve the right to make technical alterations without prior notice.

Ethernet Media

Ethernet Physical Media Connectivity

Ethernet, Economy RJ45 to RJ45 Cordsets

- For "In the Panel" applications where Industrial Cordsets are not needed
- Available in Yellow, 3 ft and 7 ft lengths only



Housing	Part Number	Application	End View	Pinout
	RJ45 RJ45 840-3FT/ECON	<ul style="list-style-type: none"> • Ethernet patch cordsets for panel connections • Economy, non industrial 	<p>Male</p> <p>12345678</p>	<ol style="list-style-type: none"> 1. WH/OG 2. OG 3. WH/GN 4. BU 5. WH/BU 6. GN 7. WH/BN 8. BN
	RJ45 RJ45 840-7FT/ECON			

We reserve the right to make technical alterations without prior notice.

Ethernet, Circuit Board Connectors and OEM Receptacles, 8-wire

- Provides (M12x1) Eurofast® 8-Pin Connection to Field Devices



Housing	Female Part Number	Male Part Number	Features	Pinout
<p>FK 84 PCB KIT</p>	<p>FK 84-PCB KIT</p>	<p>FS 84-PCB KIT</p>	<p>Nickel plated CuZn or stainless steel, 36 VDC, 1.5 A, -40 °C to +80 °C, Eurofast with mounting kit</p>	<p>Female</p>
<p>FS 84 PCB KIT</p>				<p>Male</p>
<p>FK 84 PCB</p>	<p>FK 84-PCB</p>		<p>Nickel plated CuZn or stainless steel, 36 VDC, 1.5 A, -40 °C to +80 °C, Eurofast</p>	

We reserve the right to make technical alterations without prior notice.

Standard housing material is nickel plated brass "FSV .."; "FKV ..." indicates 316 stainless steel.

Panel Cutout
FK ... FS

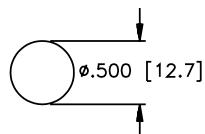

Panel Cutout
FKFD ... FSFD

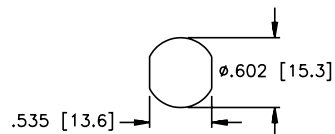

Ethernet Physical Media Connectivity

Ethernet, Circuit Board Connectors and OEM Receptacles, 8-wire

- Provides (M12x1) Eurofast® 8-Pin Connection to Field Devices



Housing	Female Part Number	Male Part Number	Features	Pinout
<p>FKFD..</p>	FKFD 84-PCB	FSFD 84-PCB	Nickel plated CuZn or stainless steel 36 VDC, 1.5 A, -40 °C to +80 °C, Eurofast PCB pins	<p>Female</p>
<p>FSFD..</p>				
<p>FKFDL</p>	FKFDL 84	FSFDL 84	Nickel plated CuZn or stainless steel 36 VDC, 1.5 A, -40 °C to +80 °C, male Eurofast solder cups	<p>Male</p>
<p>FSFDL..</p>				
<p>WFS..</p>		WFS 84-PCB	Nickel plated CuZn or stainless steel 36 VDC, 1.5 A, -40 °C to +80 °C, male Eurofast right angle PCB pins	

We reserve the right to make technical alterations without prior notice.

Standard housing material is nickel plated brass "FKFD.."; "FKFDV.." indicates 316 stainless steel.

Panel Cutout
FKFD ... FSFD

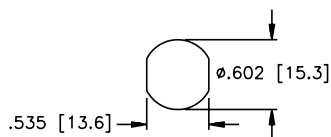

Panel Cutout
WFS

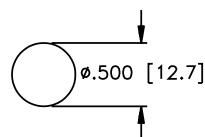

Ethernet, Cable Specifications, 4-wire

- Cable that meets the requirements of TIA/EIA568-C Category 5e performance requirements cable for 10 and 100 Base-T Ethernet
- Compliant with EtherNet/IP standards
- Cable is UL Rated for Sunlight and Oil Resistant

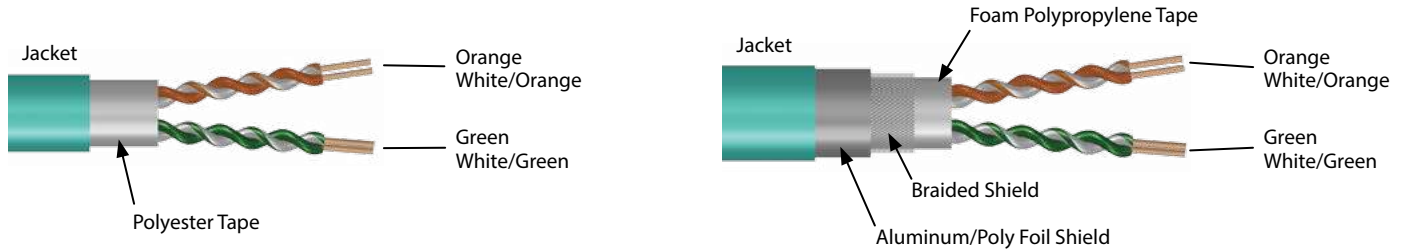

Maximum 100 meters of cable of which:

- 90 meters Horizontal Cable (SOLID - 442 or 443)
- 2 x 5 meters Patch Cables (STRANDED - 440 or 441)





We reserve the right to make technical alterations without prior notice.

Type	Approvals	Data Pair		Outer Jacket Material Color Nominal O.D.	Shields Type	Bulk Cable Part Number / Weight/300 M	Flexlife Ratings
		AWG Color Code	DCR (/1000 feet) Insulation				
440 80 °C, 600 V	c(UL)us Type CM AWM	2UTPx24 AWG Stranded	26.5 Ohms PE	TPE Teal 6.1 mm (.240 in)	-	RB51210-*M 26 lbs. Flexlife®	10xO.D. 1 million cycles 20xO.D. 10 million cycles
441 80 °C, 600 V	c(UL)us Type CM AWM	2UTPx24 AWG Stranded	26.5 Ohms PE	TPE Teal 6.7 mm (.240 in)	Foil/Braid	RB51211-*M 35 lbs. Flexlife	10xO.D. 1 million cycles 20xO.D. 10 million cycles
442 75 °C, 300 V	c(UL)us Type CM	2UTPx24 AWG Solid	31.5 Ohms PE	TPE Teal 6.1 mm (.220 in)	-	RB51212-*M 18 lbs.	-
443 80 °C, 600 V	c(UL)us Type CM AWM	2UTPx24 AWG Solid	31.5 Ohms PE	TPE Teal 6.9 mm (.270 in)	Foil/Braid	RB51213-*M 38 lbs.	-

* Indicates length in meters.
Standard spool lengths are 30, 75, 100, 150, 200, 225, 300 meters. Consult factory for other lengths.

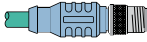
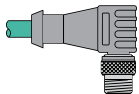
Ethernet Physical Media Connectivity

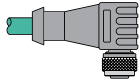
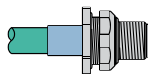
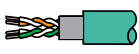
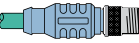
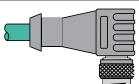
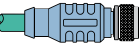
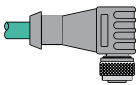

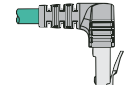
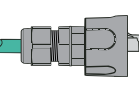
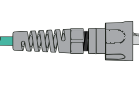

Ethernet, (M12x1) Eurofast®, RJ45 Cables and Extensions - Unshielded D-coded

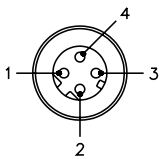
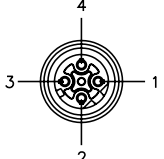
		Eurofast					
		Male		Female		Male	
		 11 RSCD	 2 WSCD	 12 RKCD	 4 WKCD	 13 FSFDD	
	 Bare	RSCD 44x-*M	WSCD 44x-*M	RKCD 44x-*M	WKCD 44x-*M	FSFDD 44x-*M	
Eurofast	Male	 11 RSCD	RSCD RSCD 44x-*M	RSCD WSCD 44x-*M	RSCD RKCD 44x-*M	RSCD WKCD 44x-*M	RSCD FSFDD 44x-*M
		 2 WSCD	WSCD RSCD 44x-*M	WSCD WSCD 44x-*M	WSCD RKCD 44x-*M	WSCD WKCD 44x-*M	WSCD FSFDD 44x-*M
	Female	 12 RKCD		RKCD RKCD 44x-*M			RKCD FSFDD 44x-*M
		 4 WKCD			WKCD RKCD 44x-*M	WKCD WKCD 44x-*M	WKCD FSFDD 44x-*M
RJ45	RJ45 Plug	 17 RJ45					RJ45 FSFDD 44x-*M
	WRJ45 Plug	 18 WRJ45E					WRJ45E FSFDD 44x-*M
	RJ45M IP67 Plug	 19 RJ45MIP67					RJ45MIP67 FSFDD 44x-*M
	RJ45 IP67 Plug	 20 RJ45IP67					RJ45IP67 FSFDD 44x-*M

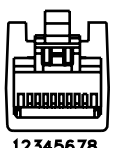
We reserve the right to make technical alterations without prior notice.

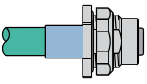
Eurofast	Pinouts	Eurofast
Male		Female
	1. White/Orange (+ tx) 2. White/Green (+rx) 3. Orange (-tx) 4. Green (-rx)	

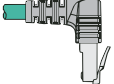
RJ45 Pinout	RJ45 Plug	RJ45 (CR) Pinout
1. White/Orange 2. Orange 3. White/Green 4. N/C 5. N/C 6. Green 7. N/C 8. N/C	Male  12345678	1. White/Green 2. Green 3. White/Orange 4. N/C 5. N/C 6. Orange 7. N/C 8. N/C

Eurofast	RJ45			
Female	RJ45 Plug	WRJ45 Plug	RJ45M IP67 Plug	RJ45 IP67 Plug
 14 FKFDD	 17 RJ45	 18 WRJ45E	 19 RJ45MIP67	 20 RJ45IP67
FKFDD 44x-*M	RJ45 44x-*M	WRJ45E 44x-*M	RJ45MIP67 44x-*M	RJ45IP67 44x-*M
RSCD FKFDD 44x-*M	RSCD RJ45 44x-*M	RSCD WRJ45E 44x-*M	RSCD RJ45MIP67 44x-*M	RSCD RJ45IP67 44x-*M
WSCD FKFDD 44x-*M	WSCD RJ45 44x-*M	WSCD WRJ45E 44x-*M	WSCD RJ45MIP67 44x-*M	WSCD RJ45IP67 44x-*M
RKCD FKFDD 44x-*M	RKCD RJ45 44x-*M	RKCD WRJ45E 44x-*M	RKCD RJ45MIP67 44x-*M	RKCD RJ45IP67 44x-*M
WKCD FKFDD 44x-*M	WKCD RJ45 44x-*M	WKCD WRJ45E 44x-*M	WKCD RJ45MIP67 44x-*M	WKCD RJ45IP67 44x-*M
RJ45 FKFDD 44x-*M	RJ45 RJ45 44x-*M		RJ45 RJ45MIP67 44x-*M	RJ45 RJ45IP67 44x-*M
WRJ45E FKFDD 44x-*M	WRJ45E RJ45 44x-*M	WRJ45E WRJ45E 44x-*M	WRJ45E RJ45MIP67 44x-*M	WRJ45E RJ45IP67 44x-*M
RJ45MIP67 FKFDD 44x-*M			RJ45MIP67 RJ45MIP67 44x-*M	
RJ45IP67 FKFDD 44x-*M			RJ45IP67 RJ45MIP67 44x-*M	RJ45IP67 RJ45IP67 44x-*M

We reserve the right to make technical alterations without prior notice.

Ethernet Media

See pages K20 - K21 for dimensional drawings.

* Indicates length in meters.





x Indicates cable type.

Standard cable lengths are 1, 2, 4, 6, 8, 10, 15, and in +5 meter increments from there. Consult factory for other lengths.

For right angle RJ45, select WRJ45I for internal tab or WRJ45E for external tab.

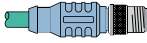
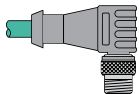
Ethernet Physical Media Connectivity

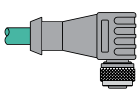
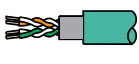
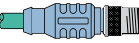
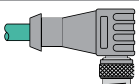
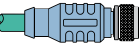
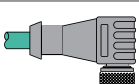

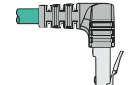
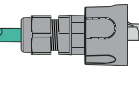

Ethernet, (M12x1) Eurofast®, RJ45, Cables and Extensions - Shielded Cable D-coded

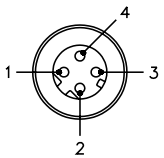
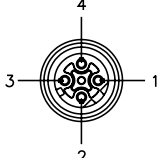
		Eurofast				
		Male		Female		
		11 	2 	12 	4 	
		RSSD	WSSD	RKSD	WKSD	
		 Bare	RSSD 44x-*M	WSSD 44x-*M	RKSD 44x-*M	WKSD 44x-*M
Eurofast	Male	11 	RSSD RSSD 44x-*M	RSSD WSSD 44x-*M	RSSD RKSD 44x-*M	RSSD WKSD 44x-*M
		2 	WSSD RSSD 44x-*M	WKSD WSSD 44x-*M	WSSD RKSD 44x-*M	WSSD WKSD 44x-*M
	Female	12 			RKSD RKSD 44x-*M	
		4 			RKSD WKSD 44x-*M	WKSD WKSD 44x-*M
RJ45	RJ45 Plug	17 				
	WRJ45 Plug	18 				
	RJ45M IP67 Plug	19 				
		RJ45S				
		WRJ45ES				
		RJ45SMIP67				

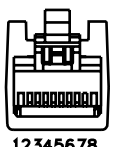
We reserve the right to make technical alterations without prior notice.

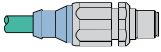
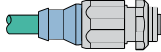
Eurofast	Pinouts	Eurofast
Male		Female
	1. White/Orange (+ tx) 2. White/Green (+rx) 3. Orange (-tx) 4. Green (-rx)	

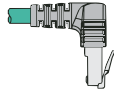
RJ45 Pinout	RJ45 Plug	RJ45 (CR) Pinout
1. White/Orange 2. Orange 3. White/Green 4. N/C 5. N/C 6. Green 7. N/C 8. N/C	Male  12345678	1. White/Green 2. Green 3. White/Orange 4. N/C 5. N/C 6. Orange 7. N/C 8. N/C

Eurofast		RJ45		
Male	Female	RJ45 Plug	WRJ45 Plug	RJ45M IP67 Plug
 15 FSSDED	 16 FKSDED	 17 RJ45S	 18 WRJ45ES	 19 RJ45SMIP67
FSSDED 44x-*M	FKSDED 44x-*M	RJ45S 44x-*M	WRJ45ES 44x-*M	RJ45SMIP67 44x-*M
RSSD FSSDED 44x-*M	RSSD FKSDED 44x-*M	RSSD RJ45S 44x-*M	RSSD WRJ45ES 44x-*M	RSSD RJ45SMIP67 44x-*M
WSSD FSSDED 44x-*M	WSSD FKSDED 44x-*M	WSSD RJ45S 44x-*M	WSSD WRJ45ES 44x-*M	WSSD RJ45SMIP67 44x-*M
RKSD FSSDED 44x-*M	RKSD FKSDED 44x-*M	RKSD RJ45S 44x-*M	RKSD WRJ45ES 44x-*M	RKSD RJ45SMIP67 44x-*M
WKSD FSSDED 44x-*M	RSSD FKSDED 44x-*M	WKSD RJ45S 44x-*M	WKSD WRJ45ES 44x-*M	WKSD RJ45SMIP67 44x-*M
RJ45S FSSDED 44x-*M	RJ45S FKSDED 44x-*M	RJ45S RJ45S 44x-*M		RJ45S RJ45SMIP67 44x-*M
WRJ45ES FSSDED 44x-*M	WRJ45ES FKSDED 44x-*M	WRJ45ES RJ45S 44x-*M	WRJ45ES WRJ45ES 44x-*M	WRJ45ES RJ45SMIP67 44x-*M
RJ45SMIP67 F5FD 84x-*M	RJ45SMIP67 FKFD 84x-*M			RJ45SMIP67 RJ45SMIP67 44x-*M

We reserve the right to make technical alterations without prior notice.

Ethernet Media

See pages K20 - K21 for dimensional drawings.

* Indicates length in meters.

x Indicates cable type.

Standard cable lengths are 1, 2, 4, 5, 6, 8, 10, 15, and in +5 meter increments from there. Consult factory for other lengths.

For stainless steel coupling nuts change part number RSSD ... RSSDV, FSSDED ... FSSDEDV.

For right angle RJ45, select WRJ45I for internal tab or WRJ45E for external tab.

Specifications

Overmold:	TPU	Protection:	NEMA 1, 3, 4, 6P and IEC IP 67
Coupling Nut:	Nickel Plated CuZn or Stainless Steel	Rated Voltage:	250 V
Contact Carrier:	TPU or POM (Nylon)	Rated Current:	4 A
Contacts:	Gold Plated CuZn	Ambient Temperature:	-40 °C to +80 °C (32 °F to +176 °F)

11

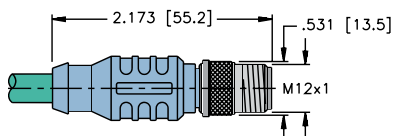

RSCD/RSSD ..

Page K16

12

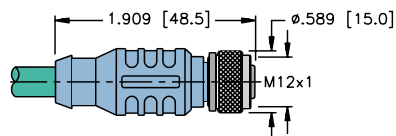

RKCD/RKSD ..

Page K16

13

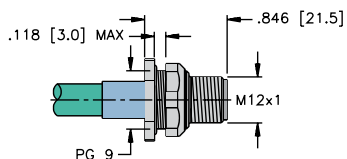

FSFDD ..

Page K16

14

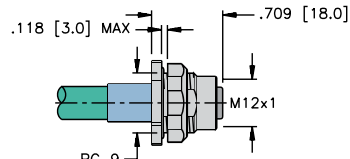

FKFDD ..

Page K17

15

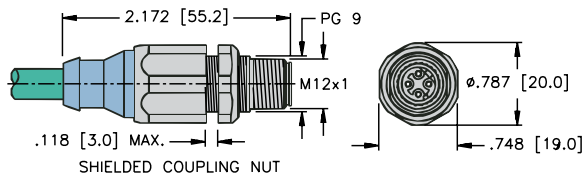

FSSDED ..

Page K19

16

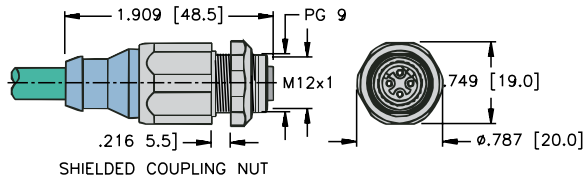

FKSDED ..

Page K19

We reserve the right to make technical alterations without prior notice.

Specifications

Overmold:	TPU	Rated Voltage:	42 V
Plug Material:	Polycarbonate	Rated Current:	1.5 A
Protection:	NEMA and IEC IP 20	Ambient Temperature:	-25 °C to +80 °C (-22 °F to +176 °F)

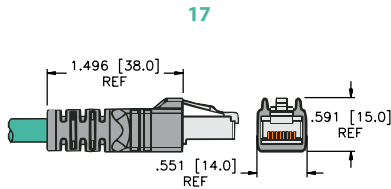

RJ45/RJ45S ..

Page K16

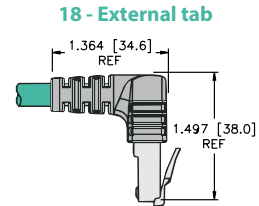

WRJ45E/WRJ45ES ..

External tab

Page K16

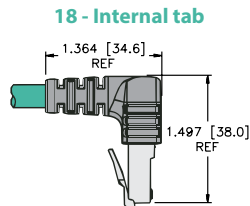

WRJ45I/WRJ45IS ..

Internal tab

Page K16

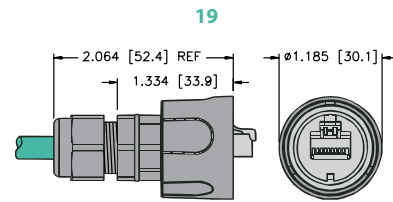

RJ45MIP67/RJ45SMIP67..

Page K16

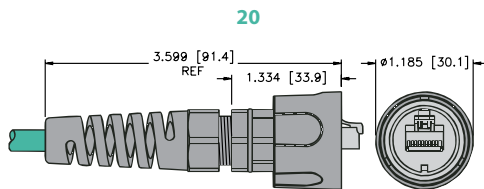

RJ45IP67 ..

Page K16

We reserve the right to make technical alterations without prior notice.

Ethernet Media

Ethernet Physical Media Connectivity

Ethernet, Receptacle

- Transitions from a RJ45 Connector to a 4-wire Eurofast® Connector



Housing Style	Part Number	Features
	FKSD RJ45SF 44	Polyurethane, TPU Overmold, 42 V, 1.5 A, -40 °C to +75 °C
	FKSD RJ45SF 44/ST	Polyurethane, TPU Overmold, 42 V, 1.5 A, -40 °C to +75 °C
	FKD FKD 44/M12	4 A, 50 V, -25 °C to +85 °C, wired one-to-one

We reserve the right to make technical alterations without prior notice.

Panel mounting clearance hole 19/32" (15 mm). Panel thickness: .060-.120" (1.5-3 mm)

Wiring Diagrams

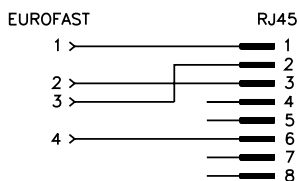

Ethernet, 4-Pin D-coded Field Wireables

- Allows for Quick Connections when Pre-Molded Cables are not available
- Available in Male, Straight and Right Angle Connector configurations



We reserve the right to make technical alterations without prior notice.

Housing Style	Female Part Number	Male Part Number	Features	Pinout
<p>CMBD 81..</p>	CMBD 8141-0/PG9	CMBSD 8141-0/PG9	4 A, 250 V, -40 °C to +85 °C, mates with female 4-pin D-coded Eurofast® cordsets and receptacles	<p>Female</p>
<p>CMBSD 81..</p>				
<p>CMBD 82..</p>	CMBD 8241-0/PG9	CMBSD 8241-0/PG9		<p>Male</p>
<p>CMBSD 82..</p>				

Ethernet Physical Media Connectivity

Ethernet, RJ45 Field Wireable

- Allows for Quick Connections in the field
- Fully Shielded
- Includes assembly instructions



Housing	Part Number	Features	Pinout
<p>M10 NUT W/CABLE CLAMPING</p> <p>2.052 [52.1] .306 [7.8] .454 [11.5] .443 [11.2]</p>	Connector, RJ45S IDC	22-24 AWG stranded, 22-23 AWG solid, -40 °C to +70 °C	<p>Male</p>
<p>.636 [16.2] 2.015 [51.2] .544 [13.8]</p>	Connector, FW, RJ45S 84 IDC	22-27 AWG stranded, 22-24 AWG solid, -40 °C to +85 °C, Cat 6 A	<p>Male</p>
<p>2.020 [51.3] .578 [14.7] .539 [13.7]</p>	Connector, FW, RJ45S 86 IDC CAT 6	22-26 AWG, -40 °C to +70 °C, Cat 6 A	<p>Male</p>

We reserve the right to make technical alterations without prior notice.

Part Number Keys	L2
Cable Specifications	L3
Cordsets	L4
Receptacles	L8
Field Wireables	L10

Features

- CAT 5e rated cables
- 2 Pair cable option
- 4-pin D-coded M12 connectors
- RJ45 connectors
- Up to 4 Amps and 250 Volt rated
- IP67 rated



PROFINET Physical Media Connectivity

Eurofast® Cordset Part Number Key

Part Number Keys are to assist in IDENTIFICATION ONLY. Consult factory for catalog items not identified.

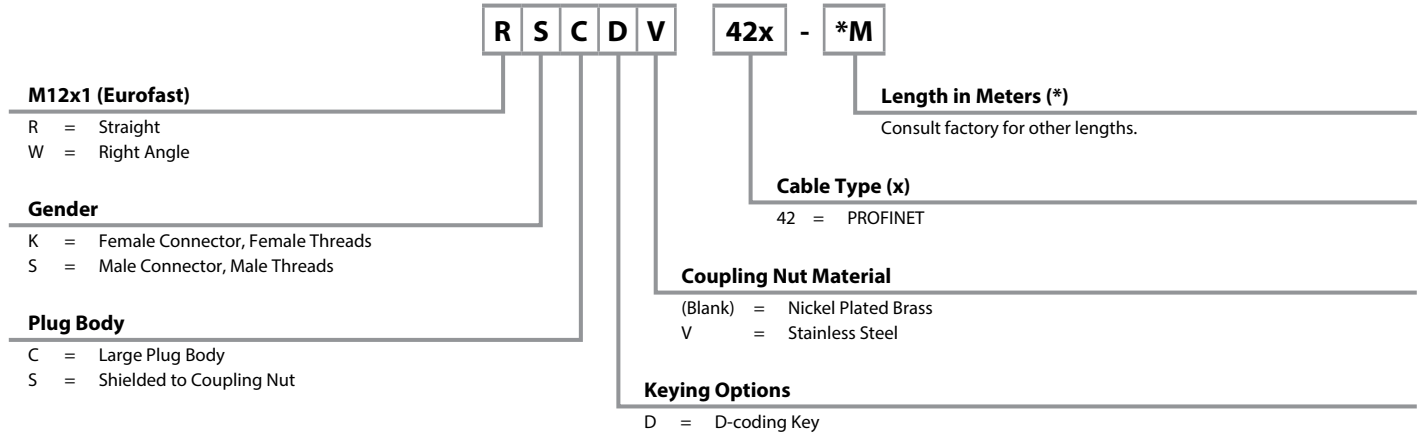

Eurofast Receptacle Part Number Key

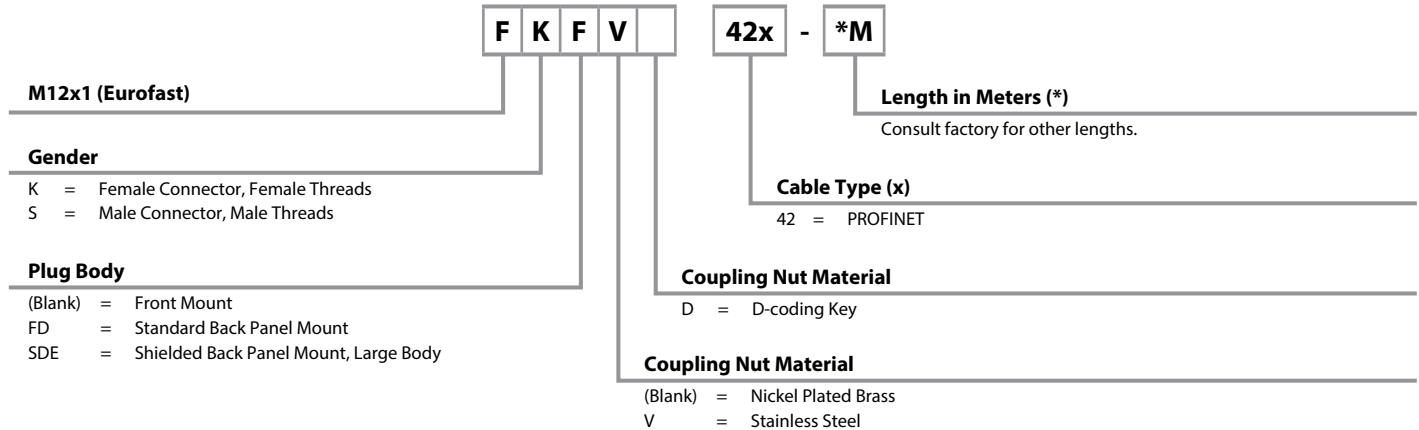

RJ Network Cordsets Part Number Key

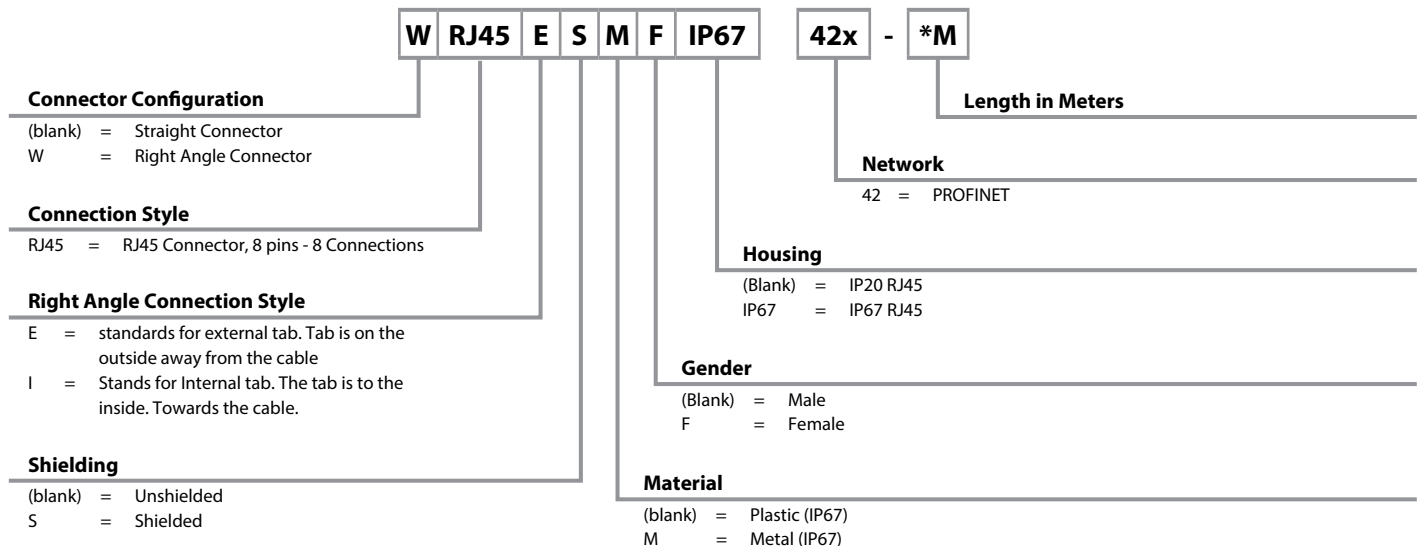

PROFINET, Cable Specifications, 4-wire

- Compliant with PROFINET Cable Standards
- Cable is UL Rated for Sunlight and Oil Resistant

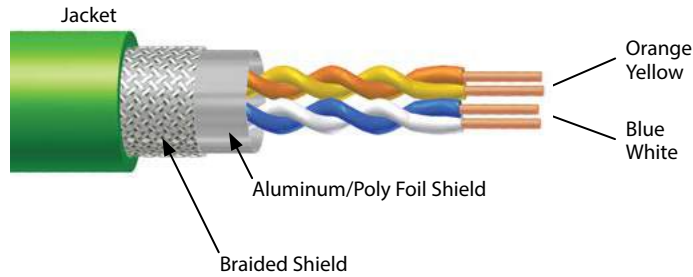

We reserve the right to make technical alterations without prior notice.





PROFINET Media

Version	Type	Approvals	Data Pair		Outer Jacket Material Color Nominal O.D.	Shields Type	Bulk Cable Part Number / Weight/300 M
			AWG Color Code	DCR (/1000 feet) Insulation			
Type A Stationary with solid conductors	421 80 °C, 600 V	UL ITC/PLTC AWM	4UTPX22 AWG Solid	17.2 Ohm	TPE/Green 7.8 mm	Foil/Braid	RB51604* ^M , 49 lbs.
Type C Highly flexible with stranded conductors	423 80 °C, 600 V	UL ITC/PLTC	4UTPX22 AWG Stranded	17.5 Ohm	TPE/Green 8.1 mm	Foil/Braid	RB51216* ^M , 49 lbs. Flexlife®

* Indicates length
Standard spool lengths are 30, 75, 100, 150, 200, 225, 300 meters. Consult factory for other lengths.

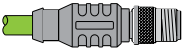
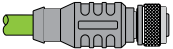
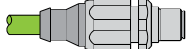
PROFINET Physical Media Connectivity

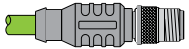
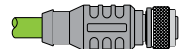
PROFINET, (M12x1) Eurofast®, RJ45, Cables and Extensions - Shielded Cable D-coded

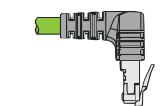
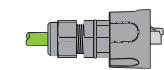
		Eurofast (Male)	Eurofast (Female)	Eurofast (Male)	Eurofast (Female)
		1 	2 	3 	4 
		RSSD	RKSD	FSSDED	FKSDED
		RSSD 42x-*M	RKSD 42x-*M	FSSDED 42x-*M	FKSDED 42x-*M
Bare					
Eurofast (Male)	1 	RSSD RSSD 42x-*M	RSSD RKSD 42x-*M	RSSD FSSDED 42x-*M	RSSD FKSDED 42x-*M
	RSSD				
Eurofast (Female)	2 		RKSD RKSD 42x-*M	RKSD FSSDED 42x-*M	RKSD FKSDED 42x-*M
	RKSD				
RJ45 Plug	5 			RJ45S FSSDED 42x-*M	RJ45S FKSDED 42x-*M
	RJ45S				
WRJ45 Plug	6 			WRJ45ES FSSDED 42x-*M	WRJ45ES FKSDED 42x-*M
	WRJ45ES				
RJ45M IP67 Plug	7 			RJ45SMIP67 FSSDED 42x-*M	RJ45SMIP67 FKSDED 42x-*M
	RJ45SMIP67				

We reserve the right to make technical alterations without prior notice.

See pages L8 - L9 for dimensional drawings.

* Indicates length in meters.

x Indicates cable type.

Standard cable lengths are 1, 2, 4, 6, 8, 10, 15, and in +5 meter increments from there. Consult factory for other lengths.



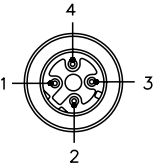
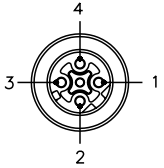

For stainless steel coupling nuts change part number RSSD ... RSSDV, FSSDED ... FSSDEDV.

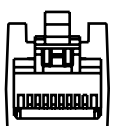
For right angle RJ45, select WRJ45I for internal tab or WRJ45E for external tab.

Eurofast	Pinouts	Eurofast
Male		Female
	1. Yellow (+tx) 2. White (+rx) 3. Orange (-tx) 4. Blue (-rx)	

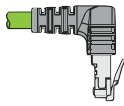
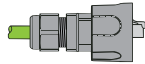
RJ45 Pinout	RJ45 Plug
1. Yellow 2. Orange 3. White 4. N/C 5. N/C 6. Blue 7. N/C 8. N/C	Male  12345678

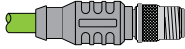
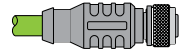
PROFINET, (M12x1) Eurofast®, RJ45, Cables and Extensions - Shielded Cable D-coded

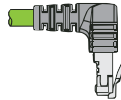
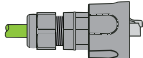
		RJ45 Plug	WRJ45 Plug	RJ45M IP67 Plug
		5  RJ45S	6  WRJ45ES	7  RJ45SMIP67
 Bare		RJ45S 42x-*M	WRJ45ES 42x-*M	RJ45SMIP67 42x-*M
Eurofast (Male)	1  RSSD	RSSD RJ45S 42x-*M	RSSD WRJ45ES 42x-*M	RSSD RJ45SMIP67 42x-*M
Eurofast (Female)	2  RKSD	RKSD RJ45S 42x-*M	RKSD WRJ45ES 42x-*M	RKSD RJ45SMIP67 42x-*M
RJ45 Plug	5  RJ45S	RJ45S RJ45S 42x-*M		RJ45S RJ45SMIP67 42x-*M
WRJ45 Plug	6  WRJ45ES	WRJ45ES RJ45S 42x-*M	WRJ45ES WRJ45ES 42x-*M	WRJ45ES RJ45SMIP67 42x-*M
RJ45M IP67 Plug	7  RJ45SMIP67	RJ45SMIP67 RJ45S 42x-*M	RJ45SMIP67 WRJ45ES 42x-*M	RJ45SMIP67 RJ45SMIP67 42x-*M

We reserve the right to make technical alterations without prior notice.

PROFINET Media

See pages L8 - L9 for dimensional drawings.

* Indicates length in meters.

x Indicates cable type.

Standard cable lengths are 1, 2, 4, 6, 8, 10, 15, and in +5 meter increments from there. Consult factory for other lengths.

For stainless steel coupling nuts change part number RSSD ... RSSDV, FSSDED ... FSSDEDV.

For right angle RJ45, select WRJ45I for internal tab or WRJ45E for external tab.

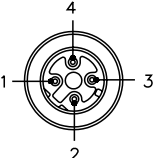
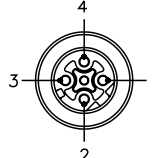
Eurofast	Pinouts	Eurofast
Male		Female
	1. Yellow (+tx) 2. White (+rx) 3. Orange (-tx) 4. Blue (-rx)	

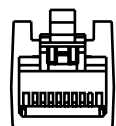
RJ45 Pinout	RJ45 Plug
1. Yellow 2. Orange 3. White 4. N/C 5. N/C 6. Blue 7. N/C 8. N/C	Male  12345678

Specifications

Overmold:	TPU	Protection:	NEMA 1, 3, 4, 6P and IEC IP 67
Coupling Nut:	Nickel Plated CuZn or Stainless Steel	Rated Voltage:	250 V
Contact Carrier:	TPU (Polyurethane) or POM (Nylon)	Rated Current:	4 A
Contacts:	Gold Plated CuZn	Ambient Temperature:	-40 °C to +80 °C (32 °F to +176 °F)

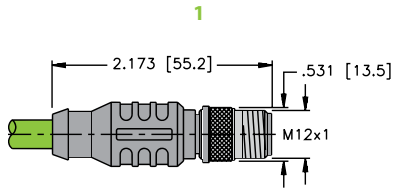

RSCD/RSSD ..

Page L4

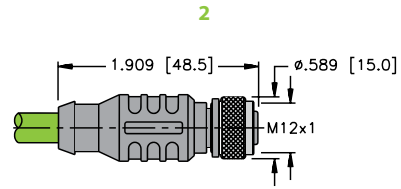

RKCD/RKSD ..

Page L4

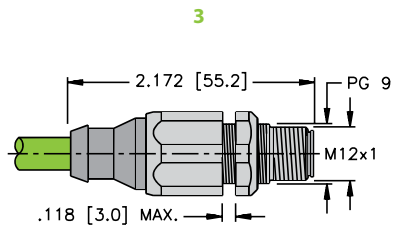

FSSDED ..

Page L4

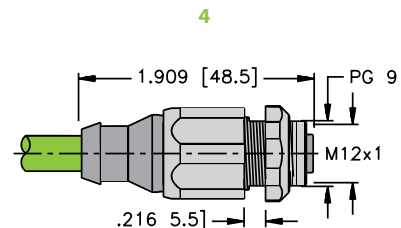

FKSDDED ..

Page L4

We reserve the right to make technical alterations without prior notice.

Specifications

Overmold:	TPU	Rated Voltage:	42 V
Plug Material:	Polycarbonate	Rated Current:	1.5 A
Protection:	NEMA 1 and IEC IP 20 and IP 67	Ambient Temperature:	-25 °C to +75 °C (-22 °F to +176 °F)

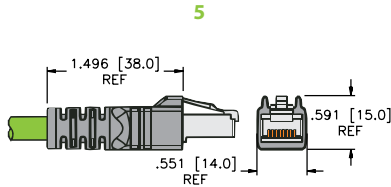

RJ45/RJ45S ..

Page L4

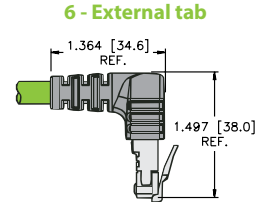

WRJ45E/WRJ45ES ..

External tab

Page L4

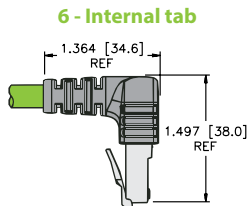

WRJ45I/WRJ45IS ..

Internal tab

Page L4

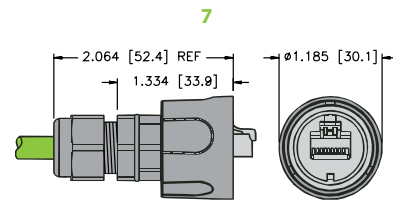

RJ45MIP67/RJ45SMIP67..

Page L4

We reserve the right to make technical alterations without prior notice.

PROFINET Media

PROFINET Physical Media Connectivity

PROFINET, Receptacle

- Transitions from a RJ45 Connector to a 4-wire Eurofast® Connector



Housing Style	Part Number	Features
	FKSD RJ45SF 44	Polyurethane, TPU Overmold, 42 V, 1.5 A, -40 °C to +75 °C
	FKSD RJ45SF 44/ST	Polyurethane, TPU Overmold, 42 V, 1.5 A, -40 °C to +75 °C
	FKD FKD 44/M12	4 A, 50 V, -25 °C to +85 °C, wired one-to-one

We reserve the right to make technical alterations without prior notice.

Panel mounting clearance hole 19/32" (15 mm). Panel thickness: .060-.120" (1.5-3 mm)

Wiring Diagrams

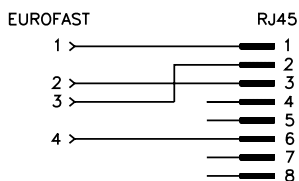

PROFINET, 4-Pin D-coded Field Wireables

- Allows for Quick Connections when Pre-Molded Cables are not available
- Available in Male, Straight and Right Angle Connector configurations



We reserve the right to make technical alterations without prior notice.

Housing Style	Female Part Number	Male Part Number	Features	Pinout
<p>CMBD 81..</p>	CMBD 8141-0/PG9	CMBSD 8141-0/PG9	4 A, 250 V, -40 °C to +85 °C, mates with female 4-pin D-coded Eurofast® cordsets and receptacles	<p>Female</p>
<p>CMBSD 81..</p>				
<p>CMBD 82..</p>	CMBD 8241-0/PG9	CMBSD 8241-0/PG9		<p>Male</p>
<p>CMBSD 82..</p>				

PROFINET Media

PROFINET Physical Media Connectivity

PROFINET, RJ45 Field Wireable

- Allows for Quick Connections in the field
- Fully Shielded
- Includes assembly instructions



Housing	Part Number	Features	Pinout
	Connector, RJ45S 42 IDC	22-26 AWG, -20 °C to 70 °C, 6 - 7 mm cable diameter	1. Yellow (+TX) 2. Orange (-TX) 3. White (+RX) 4. N/C 5. N/C 6. Blue (-RX) 7. N/C 8. N/C
	Connector, RJ45S 84 IDC (7- 8 mm)	22-26 AWG, -20 °C to 70 °C, 7 - 8 mm cable diameter	(Pinout information is shared with the row above)

We reserve the right to make technical alterations without prior notice.

Part Number Keys	M4
Cordsets	M10
Receptacles	M37
Field Wireables	M46

Features

- Cables that meet the requirements of the ODVA
- PLTC rated cable
- Available in thin, mid, and thick styles
- 7/8 and M12 connectors
- Rated up to 9 Amps and 600 Volts
- IP67/IP69K rated



DeviceNet System Description

DeviceNet is a low-cost communications protocol that eliminates hard wiring and connects industrial devices such as limit switches, photoelectric sensors, valve manifolds, motor starters, process sensors, bar code readers, variable frequency drives, panel displays and operator interfaces to a network. DeviceNet's direct connection provides improved communication between devices, as well as important device-level diagnostics not easily accessible or available through hard-wired I/O interfaces.

DeviceNet is based on the Controller Area Network (CAN) broadcast-oriented communication architecture. CAN uses a bus arbitration method (CSMA/BA) that ensures the highest priority message is given preference in the event of a data collision. The DeviceNet protocol further defines message priorities such that I/O messages are given top priority and configuration messages have lower priority.

A DeviceNet network supports up to 64 nodes and virtually an unlimited amount of I/O. The bus uses a trunkline/dropline topology, where bus power and communication are supplied on a single cable. Bus power is 24 VDC and supplies current to operate the nodes and, typically, the power input devices. Some Turck stations require an additional 24 VDC auxiliary power to supply current for outputs.

DeviceNet allows peer-to-peer data exchange (where a DeviceNet node can initiate communication with other nodes or peers), and a master/slave configuration in which the master node initiates all communication and all other nodes, or slaves, respond to the master node's requests.

Typical System Configuration

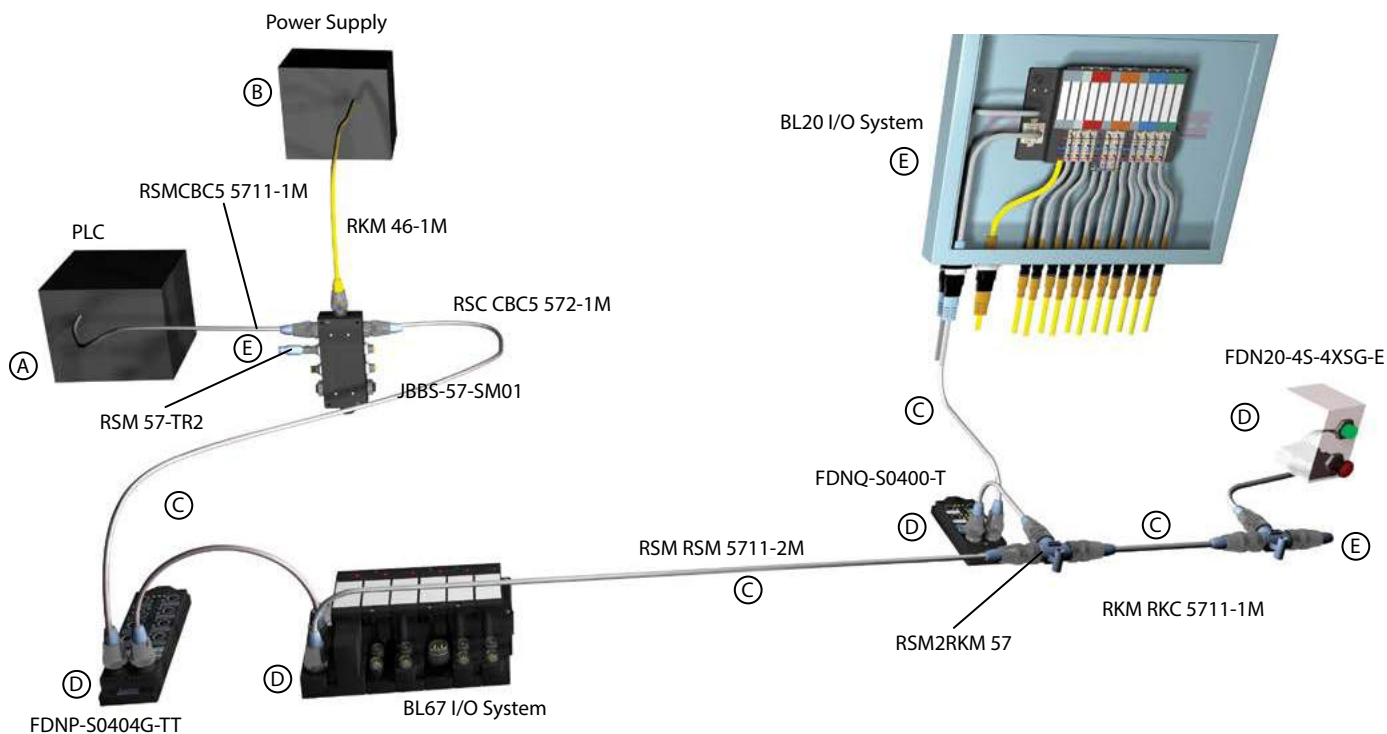

A typical DeviceNet system consists of the following parts:

- A - Controller
- B - Power Supply
- C - DeviceNet Cable
- D - DeviceNet I/O Modules (or Slaves)
- E - Terminating Resistors

DeviceNet stations require a network master (also called a scanner) to interface the stations to the host controller. Turck DeviceNet stations are designed to be fully compatible with DeviceNet equipment from other manufacturers.

Cordsets

Turck offers a complete line of molded DeviceNet cordsets to facilitate network installation, resulting in a faster start-up and fewer wiring errors. The bus and drop cables are specially designed foil-shielded, high-flex cables with very low inductance and capacitance to minimize propagation delay time. DeviceNet cables consist of a shielded and twisted data pair, as well as a shielded and twisted power pair for the 24 VDC bus power, with an additional outer shield. The 24 VDC power pair provides bus power to the station's communication electronics and (typically) to input circuits.

The data lines for CAN-High and CAN-Low differential signals conform to the CAN standard, and support network data exchange at the maximum transmission speed of 500 kbps.

In most cases, bus cable connections are made using 5-pin Minifast® (7/8-16 UN) or Eurofast® (M12) connectors. A variety of stations are also available that support terminal-block type connections. Stations with output circuits for DC actuators normally require 24 VDC auxiliary power fed through a separate connection from the communication bus.

Turck cordsets for the DeviceNet system are available in standard lengths. Contact your local sales representative to order custom lengths.

Diagnostics

Turck stations provide increased diagnostics when used with standard proximity or photoelectric sensors and discrete actuators. Turck stations also serve as a buffer between I/O devices and the DeviceNet bus by detecting short-circuits without disrupting DeviceNet communication.

For deluxe style stations, each I/O point on the station provides state and status data. State data represents the real world value of the I/O device; for example, when the sensor is on or the actuator is off. Status data indicates short-circuits in the I/O device or in the wiring between the device and the station. Some models also use status data to indicate open circuits.

State and status data are transferred to the DeviceNet scanner where it is available for fault handling in the control program. Additionally, each input and output has a multicolored LED to indicate its state and status and pinpoint I/O problems quickly; for example, the module status LED indicates the internal health of the station, and the network status LED indicates the station's communication on the DeviceNet network.

Addressing

The valid range of DeviceNet node addresses is 0 to 63. The station's default node address is 63. Each node's address must be initially set, usually via rotary dials or switches on the node. The address can also be set with a DeviceNet configuration tool.

Changes to the address settings take effect when the station power is cycled. Care must be taken to prevent the same address from being assigned to more than one node in a system. If the same address is set on multiple nodes, one node will take control of the address and the others will go into "Critical Link Failure" state, indicated by the network status LED (solid red).

DeviceNet™ Physical Media Connectivity

Minifast® Cordset Part Number Key

Part Number Keys are to assist in IDENTIFICATION ONLY. Consult factory for catalog items not identified.

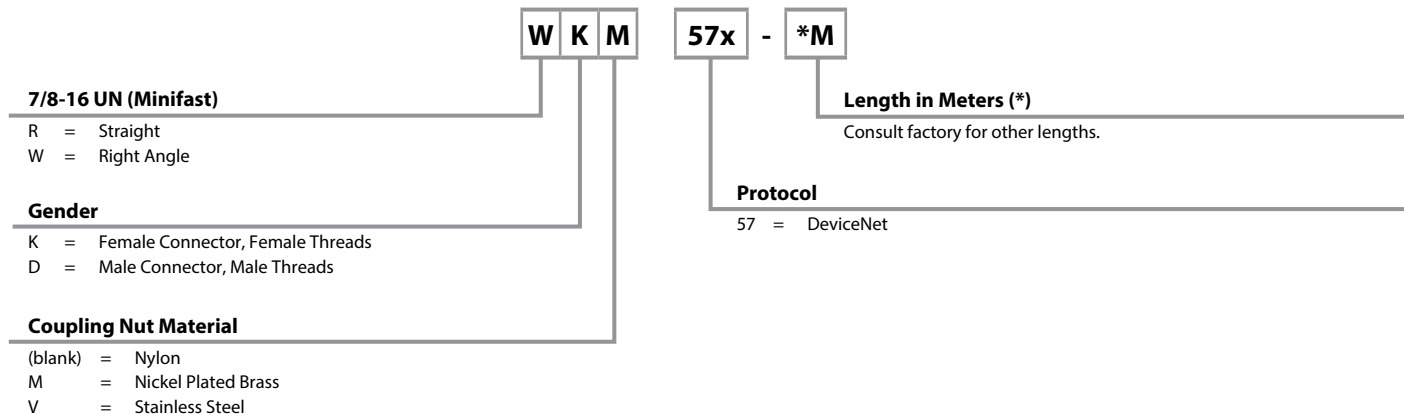

Minifast Receptacle Part Number Key

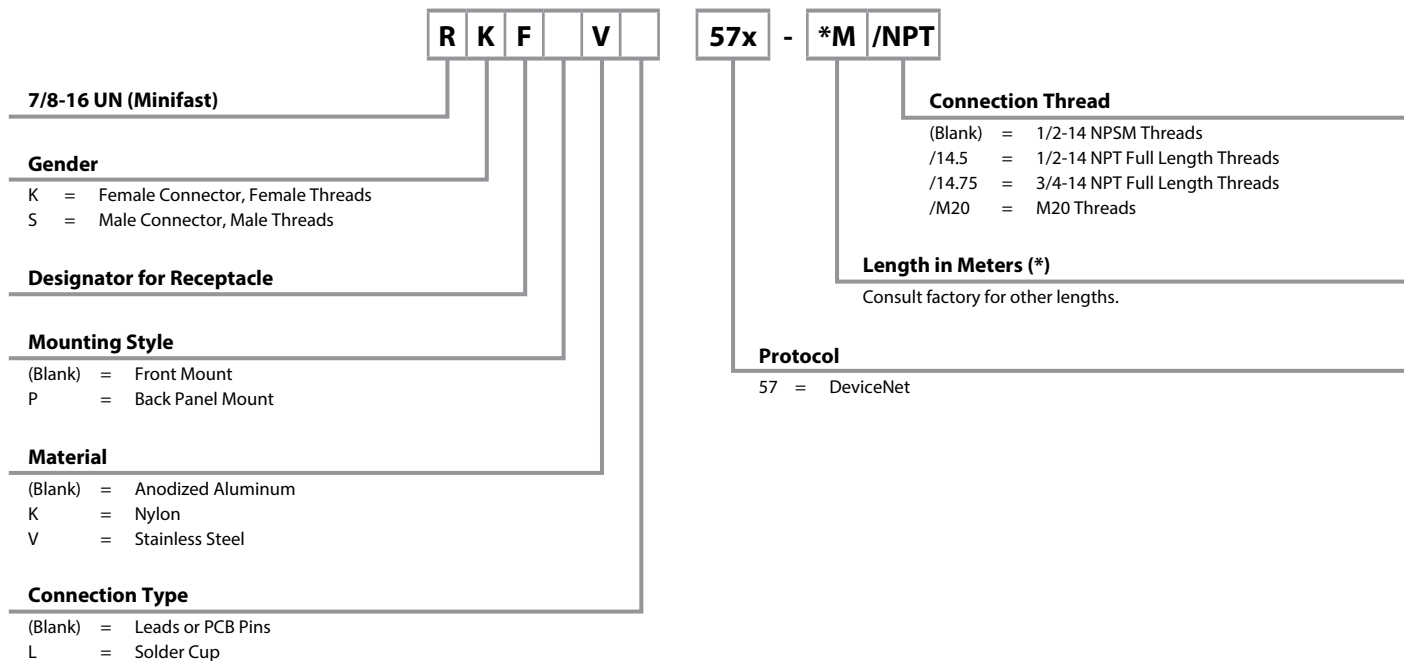

Eurofast® Cordset Part Number Key

Part Number Keys are to assist in IDENTIFICATION ONLY. Consult factory for catalog items not identified.

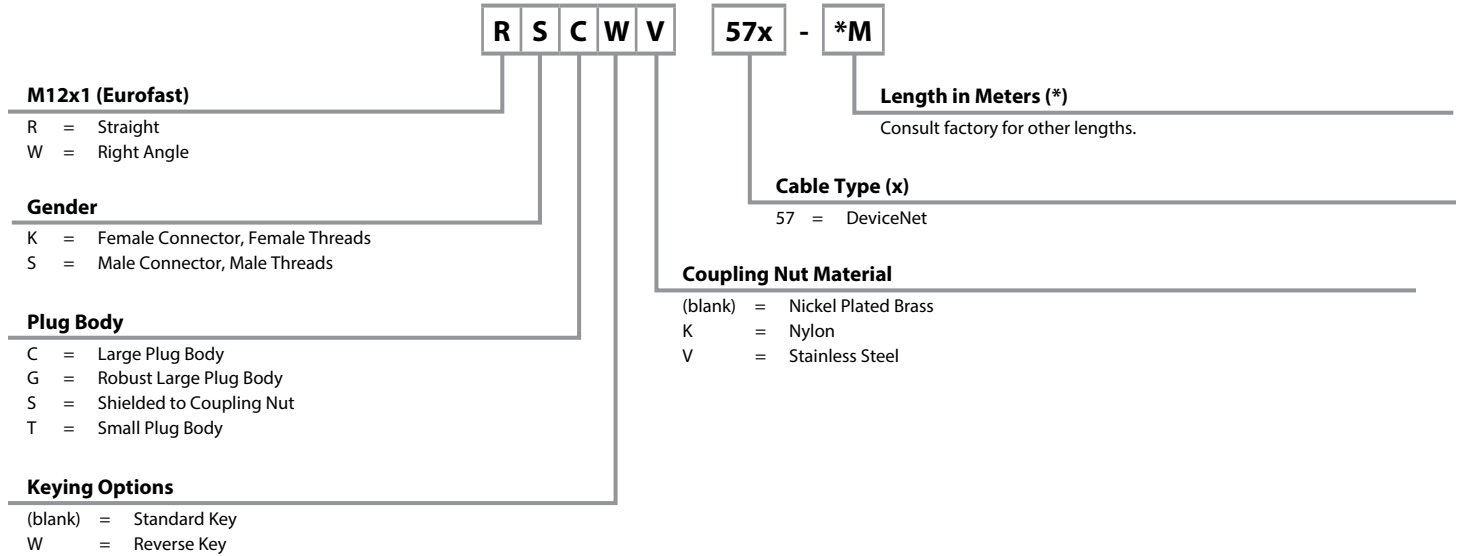

Eurofast Receptacle Part Number Key

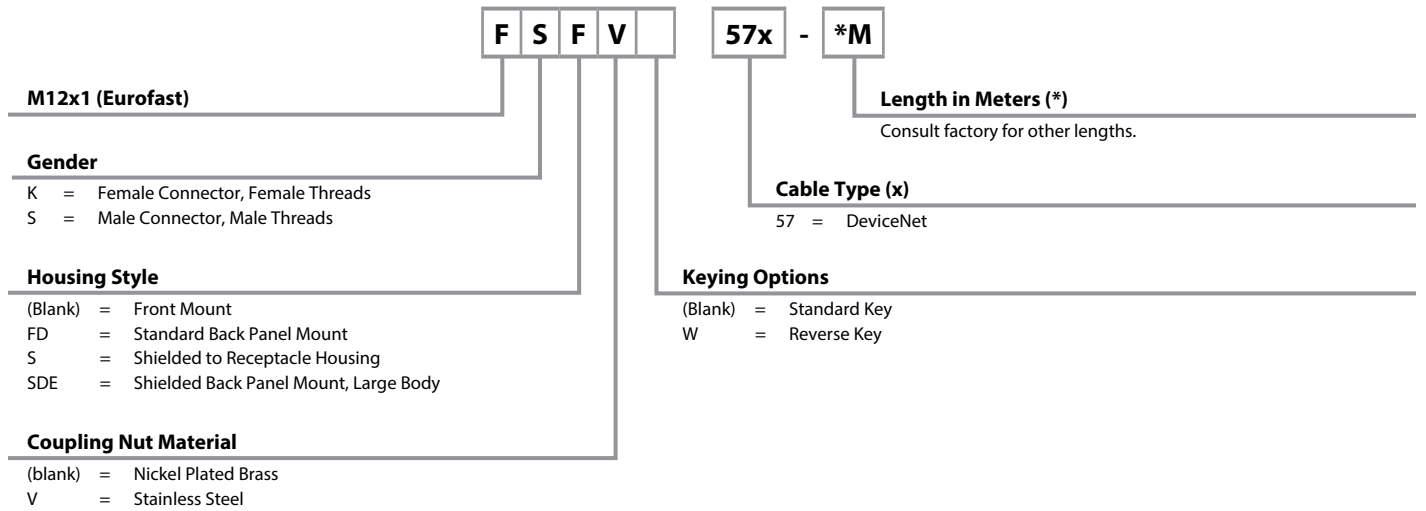

DeviceNet™ Physical Media Connectivity

Picofast® Part Number Key

Part Number Keys are to assist in IDENTIFICATION ONLY. Consult factory for catalog items not identified.

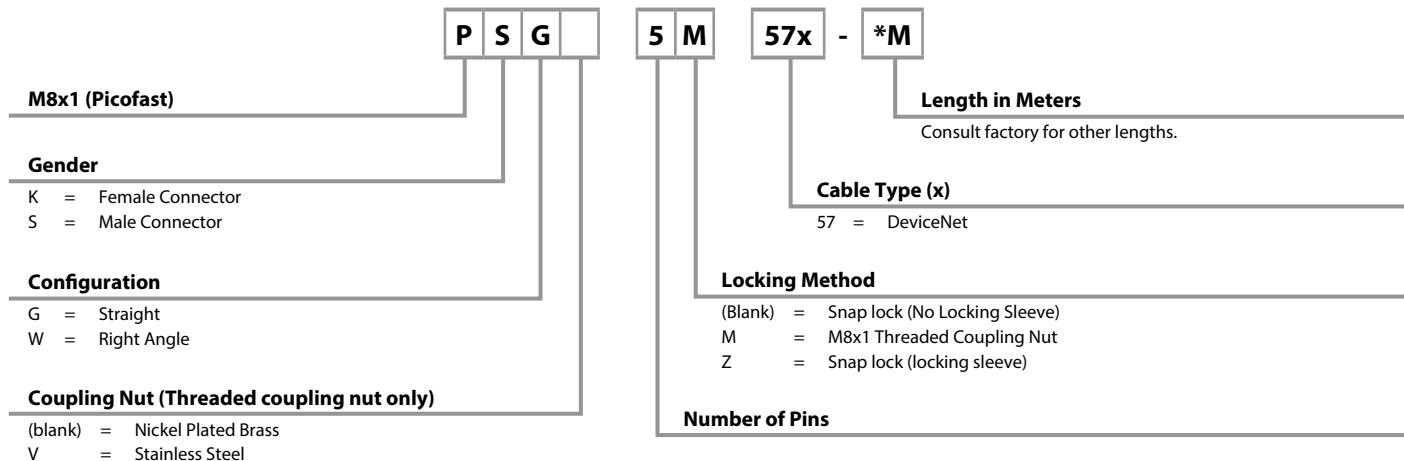

M8 Picofast Receptacle Part Number Key

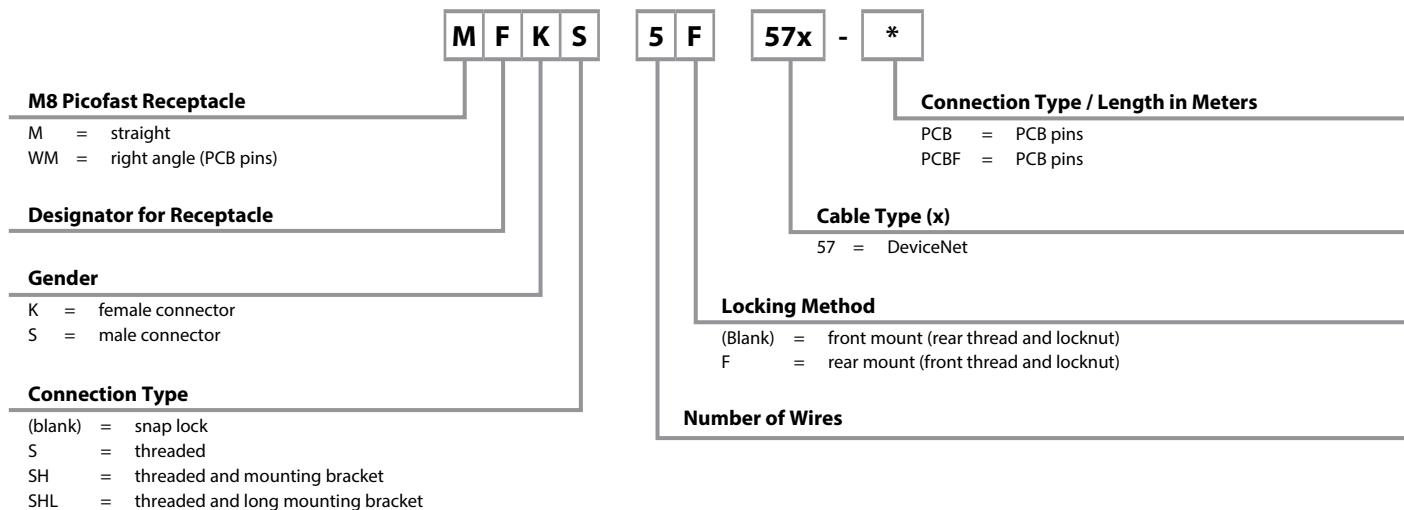

We reserve the right to make technical alterations without prior notice.

DeviceNet, Thin Cable Specifications

- Cable that meets the requirements of ODVA Thin or Type 1 Cable
- Commonly used as Drop Cable to a maximum length of 6 meters (20 Feet) or Trunk Cable in Networks up to a maximum length of 100 meters (328 feet)

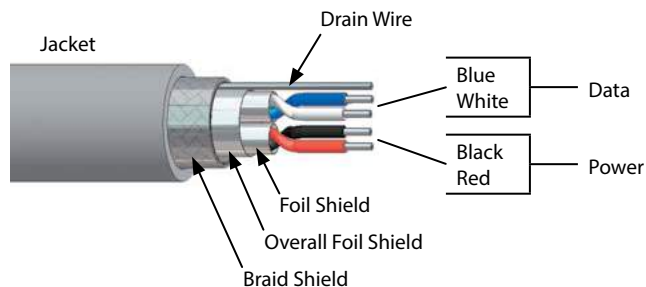

Data Rate	Maximum Trunk Length	Drop Length	
		Maximum	Cumulative
125 Kbaud	100 meters (328 feet)	6 meters (20 feet)	156 meters (512 feet)
250 Kbaud	100 meters (328 feet)		78 meters (256 feet)
500 Kbaud	100 meters (328 feet)		39 meters (128 feet)

Type	Approvals	Power Pair		Data Pair		Outer Jacket	Shields	Bulk Cable Part Number / Weight/300 M
		AWG Color Code	DCR (/1000 feet) Insulation	AWG Color Code	Characteristic Impedance 1 MHz/Insulation			
572 80 °C, 300 V	UL PLTC CSA CMX-OUTDOOR-CMG AWM I/II A/B, FT 4	2X22 AWG BK/RD	18.1 Ohms PVC	2X22 AWG BU/WH	120 Ohms HDPE	PVC, GRAY, 7.2 mm (.285 in)	Foil, 22 AWG	RB50603-*M, 44 lbs.
577 80 °C, 300 V	UL PLTC CSA CMX-OUTDOOR-CMG AWM I/II A/B, FT 4	2X22 AWG BK/RD	17.5 Ohms PVC	2X22 AWG BU/WH	120 Ohms HDPE	PVC, GRAY, 8.4 mm (.330 in)	Foil/braid, 22 AWG	RB50629-*M, 65 lbs. Flexlife®
578 80 °C, 600 V	UL PLTC, CL2 CSA CMX-OUTDOOR-CMG AWM I/II A/B, FT 4	2X22 AWG BK/RD	18.1 Ohms PVC	2X22 AWG BU/WH	120 Ohms HDPE	PVC, GRAY, 7.9 mm (.310 in)	Foil/braid, 22 AWG	RB50651-*M, 51 lbs.
5715 80 °C, 300 V	UL recognized AWM CSA AWM I/II A/B, FT 1	2X22 AWG BK/RD	18.1 Ohms PVC	2X22 AWG BU/WH	120 Ohms HDPE	PVC, GRAY, 6.0 mm (.235 in)	Foil (data only), 22 AWG	RB50764-*M, 26 lbs.
5725 80 °C, 300 V	UL recognized AWM CSA AWM I/II A/B, FT 1	2X22 AWG BK/RD	18.1 Ohms PO	2X24 AWG BU/WH	120 Ohms PE	TPU, VIOLET, 7.0 mm (.276 in)	Foil/braid, 22 AWG	RB51916-*M, 50 lbs. Halogen-free
5732 80 °C, 600 V	UL recognized AWM CSA AWM I/II A/B, FT 1	2X22 AWG BK/RD	18.1 Ohms PVC	2X22 AWG BU/WH	120 Ohms HDPE	TPE, CHARCOAL GRAY, 8.5 mm (.335 in)	Foil/braid, 22 AWG	RB51296-*M, 68 lbs. Flexlife, Weldlife

* Indicates length in meters.

Standard spool lengths are 30, 75, 100, 150, 200, 225, 300 meters. Consult factory for other lengths.

†† Zero Halogen: to DIN VDE 0472 part 815 + IEC 60754-1

We reserve the right to make technical alterations without prior notice.

DeviceNet™ Media

DeviceNet™ Physical Media Connectivity

DeviceNet, Mid Cable Specifications

- Cable that meets the requirements of ODVA Mid or Type III Cable
- Provides more flexibility when used as a Trunk Cable up to a maximum length of 300 meters (984 feet)

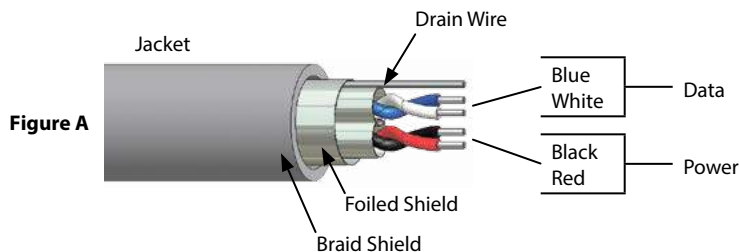

Data Rate	Maximum Trunk Length
125 Kbaud	300 meters (984 feet)
250 Kbaud	250 meters (820 feet)
500 Kbaud	100 meters (328 feet)

Type	Approvals	Power Pair		Data Pair		Outer Jacket Material Color Nominal O.D.	Shields Type Drain Wire	Bulk Cable Part Number / Weight/300 M
		AWG Color Code	DCR (/1000 feet) Insulation	AWG Color Code	Characteristic Impedance 1 MHz/Insulation			
5711 80 °C, 300 V	UL PLTC CSA CMX-OUTDOOR-CMG AWM I/II A/B, FT 4	2X16 AWG BK/RD	4.1 Ohms PVC	2X20 AWG BU/WH	120 Ohms HDPE	PVC, GRAY, 8.4 mm (.330 in)	Foil, 20 AWG	RB50721-*M, 65 lbs.
5722 80 °C, 300 V	UL PLTC CSA CMX-OUTDOOR-CMG AWM I/II A/B, FT 4	2X17 AWG BK/RD	5.8 Ohms PVC	2X20 AWG BU/WH	110 Ohms HDPE	PVC, GRAY, 8.9 mm (.350 in)	Foil, 20 AWG	RB50876-*M, 71 lbs. Flexlife®
5723 80 °C, 300 V	UL recognized AWM CSA AWM I/II A/B, FT 1	2X17 AWG BK/RD	5.8 Ohms PVC	2X20 AWG BU/WH	110 Ohms HDPE	TPU, GRAY, 8.4 mm (.330 in)	Foil, 20 AWG	RB50877-*M, 60 lbs. Flexlife
5731 80 °C, 300 V	UL recognized AWM CSA AWM I/II A/B, FT 1	2X16 AWG BK/RD	4.1 Ohms PVC	2X20 AWG BU/WH	120 Ohms HDPE	TPE, GRAY, 9.6 mm (.378 in)	Foil/braid, 20 AWG	RB51235-*M, 95 lbs. Weldlife
5737 80 °C, 300 V	UL recognized AWM CSA AWM I/II A/B, FT 1	2X17 AWG BK/RD	5.8 Ohms PVC	2X20 AWG BU/WH	110 Ohms HDPE	TPU, GRAY, 8.4 mm (.330 in)	Foil, 22 AWG	RB51903-*M, 60 lbs. C-track

* Indicates length in meters.
Standard spool lengths are 30, 75, 100, 150, 200, 225, 300 meters. Consult factory for other lengths.

We reserve the right to make technical alterations without prior notice.

DeviceNet, Thick Cable Specifications

- Cable that meets the requirements of ODVA Thick or Type 1 Cable
- It provides the most power to a Network when used as a Trunk Cable up to a maximum Standard Cable Length of 500 meters (1640 feet)

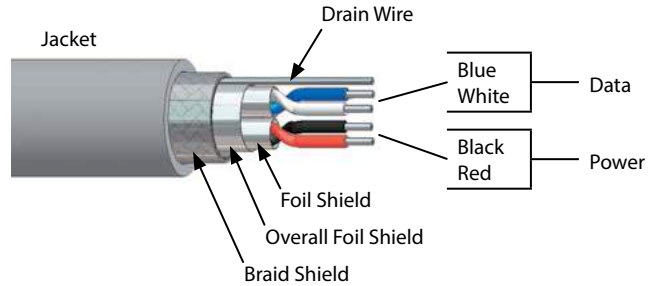

Data Rate	Maximum Trunk Length	Maximum Trunk Length (5720)
125 Kbaud	500 meters (1640 feet)	420 meters (1378 feet)
250 Kbaud	250 meters (820 feet)	200 meters (656 feet)

Type	Approvals	Power Pair		Data Pair		Outer Jacket	Shields	Bulk Cable Part Number / Weight/300 M
		AWG Color Code	DCR (/1000 feet) Insulation	AWG Color Code	Characteristic Impedance 1 MHz/Insulation			
575 80 °C, 300 V	UL recognized AWM CSA AWM I/II A/B, FT 1	2X15 AWG BK/RD	3.6 Ohms PVC	2X18 AWG BU/WH	120 Ohms HDPE	TPU, GRAY, 10.4 mm (.409 in)	Foil/braid, 18 AWG	RB50633-*M, 94 lbs.
579 80 °C, 600 V	UL PLTC, CL2 CSA CMX-OUTDOOR-CMG AWM I/II A/B, FT 4	2X15 AWG BK/RD	3.6 Ohms PVC	2X18 AWG BU/WH	120 Ohms HDPE	PVC, GRAY, 11.2 mm (.440 in)	Foil/braid, 18 AWG	RB50652-*M, 122 lbs.
5720 75 °C, 600 V	UL TC-ER CSA AWM I/II A/B, FT 1	2X16 AWG BK/RD	4.9 Ohms PVC	2X18 AWG BU/WH	120 Ohms HDPE	PVC, GRAY, 13.3 mm (.525 in)	Foil/braid, 16 AWG	RB50793-*M, 168 lbs.
5727 80 °C, 600 V	UL PLTC CSA CMX-OUTDOOR-CMG AWM I/II A/B, FT 4	2X15 AWG BK/RD	3.6 Ohms PVC	2X18 AWG BU/WH	120 Ohms HDPE	PVC, CHARCOAL GRAY, 12.5 mm (.492 in)	Foil/braid, 18 AWG	RB51106-*M, 157 lbs. Flexlife
5730 80 °C, 600 V	UL recognized AWM CSA AWM I/II A/B, FT 1	2X15 AWG BK/RD	3.6 Ohms PVC	2X18 AWG BU/WH	120 Ohms HDPE	TPE, GRAY, 10.5 mm (.254 in)	Foil/braid, 18 AWG	RB51231-*M, 110 lbs. Weldlife



* Indicates length in meters.
Standard spool lengths are 30, 75, 100, 150, 200, 225, 300 meters. Consult factory for other lengths.

We reserve the right to make technical alterations without prior notice.

DeviceNet™ Media

DeviceNet™ Physical Media Connectivity

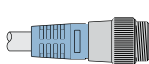
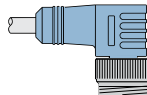
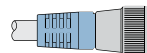
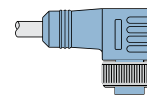
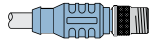
DeviceNet, Cable/Cordset Selection Matrix

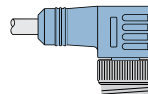
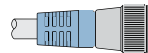
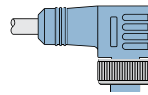
		Minifast®				Eurofast® Thin/Mid Only
		(Male)		(Female)		Male
		1 	2 	3 	4 	7 
		RSM	WSM	RKM	WKM	RSC
		RSM 57x-*M	WSM 57x-*M	RKM 57x-*M	WKM 57x-*M	RSC 57x-*M
Bare						
Minifast (Male)	1 	RSM RSM 57x-*M	RSM WSM 57x-*M	RSM RKM 57x-*M	RSM WKM 57x-*M	RSM RSC 57x-*M
	RSM					
Minifast (Female)	2 		WSM WSM 57x-*M	WSM RKM 57x-*M	WSM WKM 57x-*M	WSM RSC 57x-*M
	WSM					
Minifast (Female)	3 			RKM RKM 57x-*M	RKM WKM 57x-*M	RKM RSC 57x-*M
	RKM					
Minifast (Female)	4 				WKM WKM 57x-*M	WKM RSC 57x-*M
	WKM					

See pages M16 - M17 for dimensional drawings.

* Indicates length in meters.

x Indicates cable type.

Standard cable lengths are 1, 2, 4, 6, 8, 10, 15, and in +5 meter increments from there. Consult factory for other lengths.

For stainless steel coupling nuts change part number RSM ... to RSV, WSM ... to WSV.

We reserve the right to make technical alterations without prior notice.

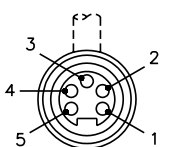
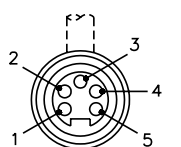
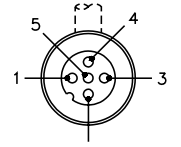
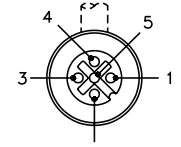
Minifast		Pinouts	Eurofast	
Male	Female		Male	Female
		1. Bare (Shield Drain Wire) 2. Red (+ Voltage) 3. Black (- Voltage) 4. White (CAN_H) 5. Blue (CAN_L)		

DeviceNet, Cable/Cordset Selection Matrix

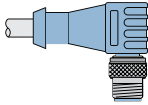
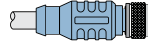
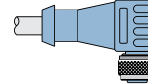
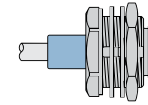
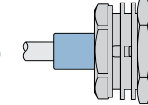
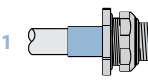
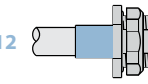



Eurofast® (Thin/Mid Only)			Minifast® Bulkhead		Eurofast Bulkhead (Thin Only)	
Male	Female	Female	Male	Female	Male	Female
 8 WSC	 9 RKC	 10 WKC	 5 RSFP	 6 RKFP	 11 FSFD	 12 FKFD
WSC 57x-*M	RKC 57x-*M	WKC 57x-*M	RSFP 57x-*M	RKFP 57x-*M	FSFD 57x-*M	FKFD 57x-*M
RSM WSC 57x-*M	RSM RKC 57x-*M	RSM WKC 57x-*M	RSM RSFP 57x-*M	RSM RKFP 57x-*M	RSM FSFD 57x-*M	RSM FKFD 57x-*M
WSM WSC 57x-*M	WSM RKC 57x-*M	WSM WKC 57x-*M	WSM RSFP 57x-*M	WSM RKFP 57x-*M	WSM FSFD 57x-*M	WSM FKFD 57x-*M
RKM WSC 57x-*M	RKM RKC 57x-*M	RKM WKC 57x-*M	RKM RSFP 57x-*M	RKM RKFP 57x-*M	RKM FSFD 57x-*M	RKM FKFD 57x-*M
WKM WSC 57x-*M	WKM RKC 57x-*M	WKM WKC 57x-*M	WKM RSFP 57x-*M	WKM RKFP 57x-*M	WKM FSFD 57x-*M	WKM FKFD 57x-*M

We reserve the right to make technical alterations without prior notice.

DeviceNet™ Media

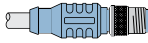
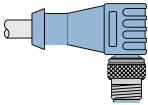
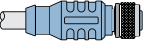
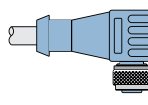
DeviceNet™ Physical Media Connectivity

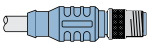
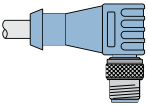
DeviceNet, Cable/Cordset Selection Matrix

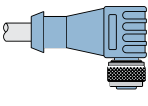
		Eurofast® (Thin/Mid Only)			
		Male		Female	
		7 	8 	9 	10 
		RSC	WSC	RKC	WKC
		RSC 57x-*M	WSC 57x-*M	RKC 57x-*M	WKC 57x-*M
Bare					
Eurofast (Male) Thin/Mid Only	7 	RSC RSC 57x-*M	RSC WSC 57x-*M	RSC RKC 57x-*M	RSC WKC 57x-*M
	RSC				
Eurofast (Female) Thin/Mid Only	8 		WSC WSC 57x-*M	WSC RKC 57x-*M	WSC WKC 57x-*M
	WSC				
Eurofast (Female) Thin/Mid Only	9 			RKC RKC 57x-*M	RKC WKC 57x-*M
	RKC				
Eurofast (Female) Thin/Mid Only	10 				WKC WKC 57x-*M
	WKC				

See pages M16 - M17 for dimensional drawings.

* Indicates length in meters.

x Indicates cable type.

Standard cable lengths are 1, 2, 4, 6, 8, 10, 15, and in +5 meter increments from there. Consult factory for other lengths.

For stainless steel coupling nuts change part number RSM ... to RSV, WSM ... to WSV.

We reserve the right to make technical alterations without prior notice.

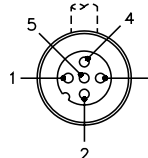
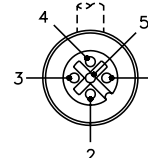
Pinouts	Eurofast	
	Male	Female
1. Bare (Shield Drain Wire) 2. Red (+ Voltage) 3. Black (- Voltage) 4. White (CAN_H) 5. Blue (CAN_L)		

DeviceNet, Cable/Cordset Selection Matrix

Minifast® Bulkhead		Eurofast® Bulkhead (Thin Only)	
Male	Female	Male	Female
 5 RSFP	 6 RKFP	 11 FSFD	 12 FKFD
RSFP 57x-*M	RKFP 57x-*M	FSFD 57x-*M	FKFD 57x-*M
RSC RSFP 57x-*M	RSC RKFP 57x-*M	RSC FSFD 57x-*M	RSC FKFD 57x-*M
WSC RSFP 57x-*M	WSC RKFP 57x-*M	WSC FSFD 57x-*M	WSC FKFD 57x-*M
RKC RSFP 57x-*M	RKC RKFP 57x-*M	RKC FSFD 57x-*M	RKC FKFD 57x-*M
WKC RSFP 57x-*M	WKC RKFP 57x-*M	WKC FSFD 57x-*M	WKC FKFD 57x-*M

We reserve the right to make technical alterations without prior notice.

DeviceNet™ Media

DeviceNet™ Physical Media Connectivity

DeviceNet, Open Connector Cordset Selection Matrix

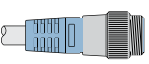
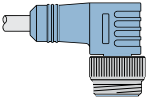
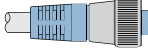
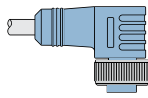
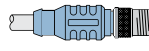
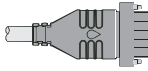
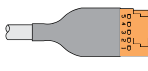
		Minifast®				Eurofast®
		(Male)		(Female)		Male
		1  RSM	2  WSM	3  RKM	4  WKM	7  RSC
15  Bare	CBC5 57x-*M	RSM CBC5 57x-*M	WSM CBC5 57x-*M	RKM CBC5 57x-*M	WKM CBC5 57x-*M	RSC CBC5 57x-*M
16  Bare	BK52C 57x-*M	RSM BK52C 57x-*M	WSM BK52C 57x-*M	RKM BK52C 57x-*M	WKM BK52C 57x-*M	RSC BK52C 57x-*M
	Thin, Mid and Thick Cable					Thin Cable Only

See pages M16 - M17 for dimensional drawings.

* Indicates length in meters.

x Indicates cable type.

Standard cable lengths are 1, 2, 4, 6, 8, 10, 15, and in +5 meter increments from there. Consult factory for other lengths.

For stainless steel coupling nut: Change part number (RSM ... to RSV, RSC ... to RSCV).

We reserve the right to make technical alterations without prior notice.

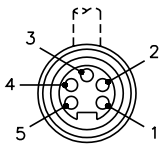
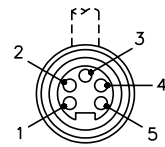
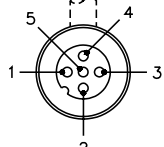
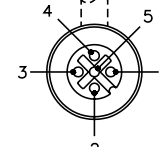
Minifast		Pinouts	Eurofast	
Male	Female		Male	Female
		1. Bare (Shield Drain Wire) 2. Red (+ Voltage) 3. Black (- Voltage) 4. White (CAN_H) 5. Blue (CAN_L)		

DeviceNet, Open Connector Cordset Selection Matrix

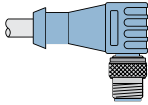
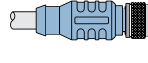
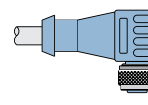
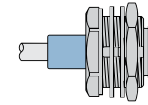
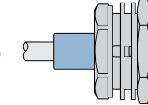
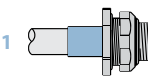
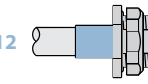
Eurofast®			Minifast® Bulkhead		Eurofast Bulkhead	
Male	Female	Female	Male	Female	Male	Female
8 	9 	10 	5 	6 	11 	12 
WSC	RKC	WKC	RSFP	RKFP	FSFD	FKFD
WSC CBC5 57x-*M	RKC CBC5 57x-*M	WKC CBC5 57x-*M	RSFP CBC5 57x-*M	RKFP CBC5 57x-*M	FSFD CBC5 57x-*M	FKFD CBC5 57x-*M
WSC BK52C 57x-*M	RKC BK52C 57x-*M	WKC BK52C 57x-*M	RSFP BK52C 57x-*M	RKFP BK52C 57x-*M	FSFD BK52C 57x-*M	FKFD BK52C 57x-*M
Thin and Mid Cable Only			Thin, Mid and Thick Cable		Thin Cable Only	

See pages M16 - M17 for dimensional drawings.

* Indicates length in meters.

x Indicates cable type.

Standard cable lengths are 1, 2, 4, 6, 8, 10, 15, and in +5 meter increments from there. Consult factory for other lengths.

Specifications

Overmold:	TPU	Rated Voltage:	250 V
Contact Carrier:	PA (Nylon)	Rated Current:	12 A
Protection:	NEMA 1, and IEC IP 20	Ambient Temperature:	-40 °C to +75 °C (-22 °F to +167 °F)

We reserve the right to make technical alterations without prior notice.

DeviceNet™ Media

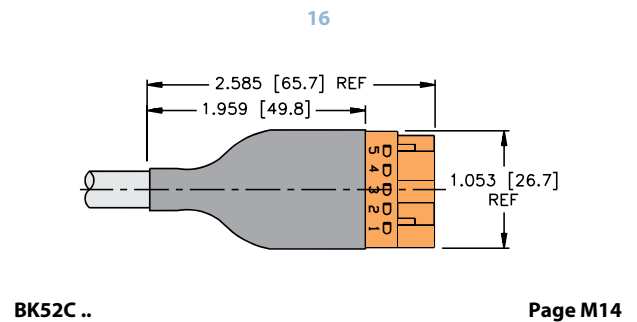
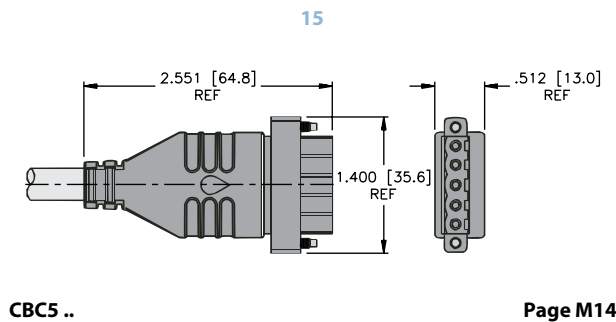

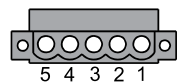
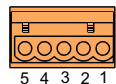
CBC5	Pinouts	BK52C
	1 = Black (- Voltage) 2 = Blue (CAN_L) 3 = Bare (Shield Drain) 4 = White (CAN_H) 5 = Red (+ Voltage)	

Specifications

Overmold:	TPU	Protection:	NEMA 1, 3, 4, 6P and IEC IP 67
Coupling Nut:	Nickel Plated CuZn or Stainless Steel	Rated Voltage:	300 V
Contact Carrier:	TPU	Ambient Temperature:	-40 °C to +75 °C (-22 °F to +167 °F)
Contacts:	Gold Plated CuZn		

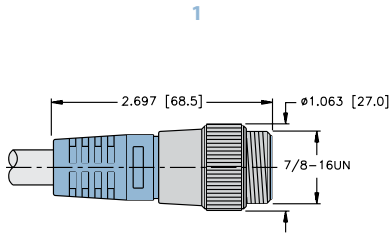

RSM ..

Page M10

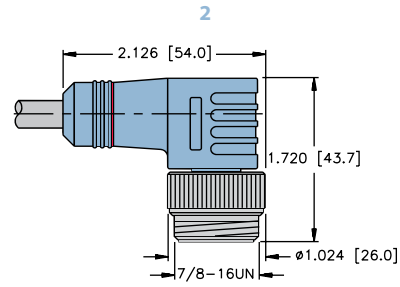

WSM ..

Page M10

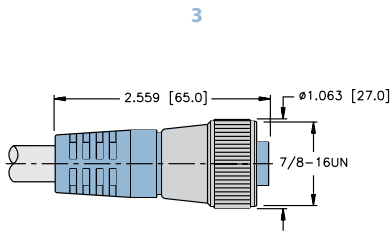

RKM ..

Page M10

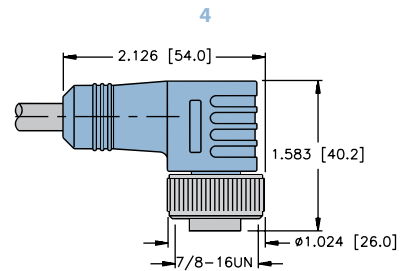

WKM ..

Page M10

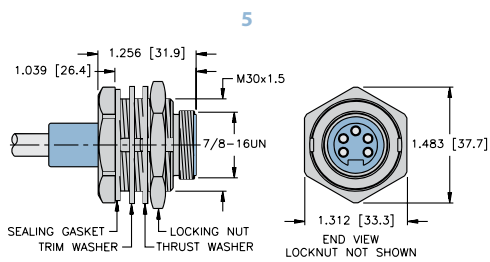

RSFP ..

Page M11

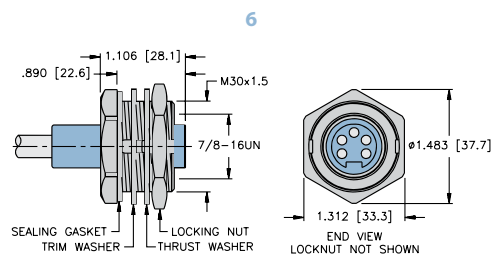

RKFP ..

Page M11

We reserve the right to make technical alterations without prior notice.

Specifications

Overmold:	TPU	Protection:	NEMA 1, 3, 4, 6P and IEC IP 68
Coupling Nut:	Nickel Plated CuZn or Stainless Steel	Rated Voltage:	250 V
Contact Carrier:	TPU or POM (Nylon)	Rated Current:	4 A
Contacts:	Gold Plated CuZn	Ambient Temperature:	-40 °C to +75 °C (-22 °F to +167 °F)

We reserve the right to make technical alterations without prior notice.

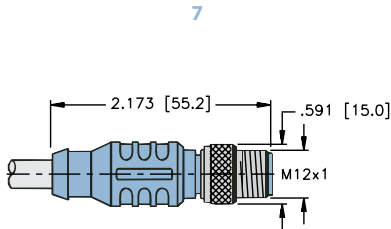

RSC ..

Page M10

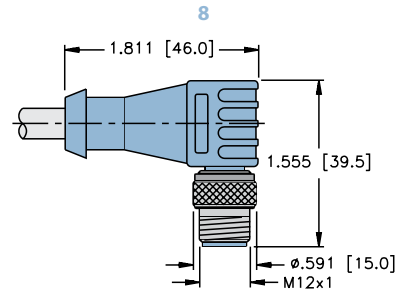

WSC ..

Page M11

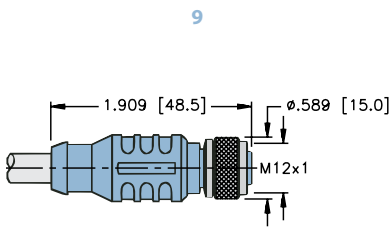

RKC ..

Page M11

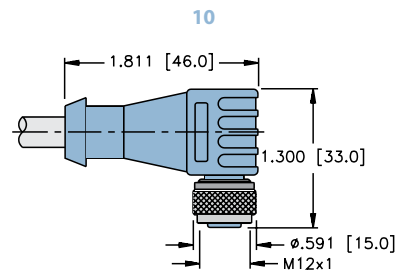

WKC ..

Page M11

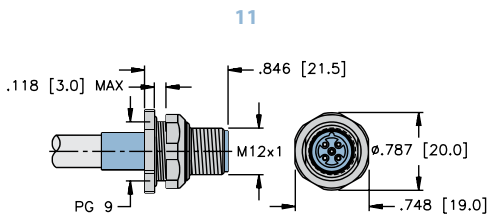

FSFD ..

Page M11

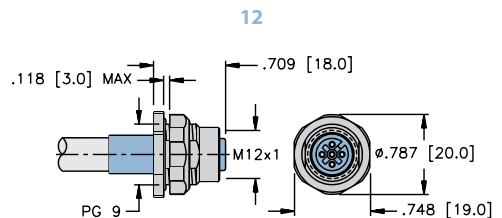

FKFD ..

Page M11

DeviceNet™ Physical Media Connectivity

DeviceNet, Pico Cable Specifications

- Cable that meets the electrical requirements of ODVA Thin Cable
- Pico Cable has 24 AWG Conductors which may be used with Picofast® Connectors

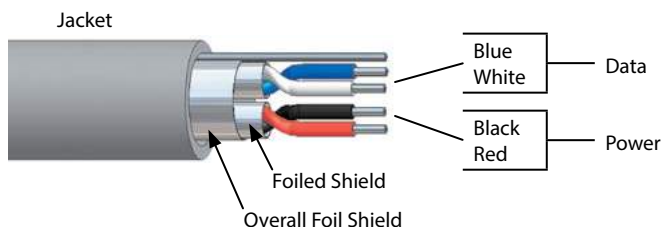

DeviceNet - Pico Cable 5724

Data Rate	Maximum Trunk Length
125 Kbaud	35 meters (115 feet)
250 Kbaud	35 meters (115 feet)
500 Kbaud	35 meters (115 feet)

DeviceNet - Thin Cable 5715

Data Rate	Maximum Trunk Length
125 Kbaud	100 meters (328 feet)
250 Kbaud	100 meters (328 feet)
500 Kbaud	100 meters (328 feet)

Type	Approvals	Power Pair		Data Pair		Outer Jacket	Shields	Bulk Cable Part Number / Weight/300 M
		AWG Color Code	DCR (/1000 feet) Insulation	AWG Color Code	Characteristic Impedance 1 MHz/Insulation	Material Color Nominal O.D.	Type Drain Wire	
5724 80 °C, 300 V	UL recognized AWM CSA AWM I/II A/B, FT 1	2X24 AWG BK/RD	24.9 Ohms PVC	2X24 AWG BU/WH	120 Ohms HDPE	PVC, GRAY, 5.7 mm (.224 in)	Foil, 24 AWG	RB51045-*M, 27 lbs.
5715 80 °C, 300 V	UL recognized AWM CSA AWM I/II A/B, FT 1	2X22 AWG BK/RD	18.1 Ohms PVC	2X22 AWG BU/WH	120 Ohms HDPE	PVC, GRAY, 6.0 mm (.235 in)	Foil (data only), 22 AWG	RB50764-*M, 26 lbs.

* Indicates length in meters.
Standard cable lengths are 1, 2, 4, 6, 8, 10, 15, and in +5 meter increments from there. Consult factory for other lengths.

We reserve the right to make technical alterations without prior notice.

DeviceNet, Cable/Cordsets Selection Matrix - Threaded

		Picofast® (M8)				Eurofast® (M12)			
		Female		Male		Male		Female	
		3 PKG 5M	4 PKW 5M	1 PSG 5M	2 PSW 5M	7 RST	8 WST	9 RKT	10 WKT
Bare		PKG 5M-57x	PKW 5M-57x	PSG 5M-57x	PSW 5M-57x	RST 57x-*	WST 57x	RKT 57x-*	WKT 57x-*
Picofast (Female)	3 PKG 5M	PKG 5M PKG 5M-57x	PKG 5M PKW 5M-57x	PKG 5M PSG 5M-57x	PKG 5M PSW 5M-57x	PKG 5M RST 57x*M	PKG 5M WST 57x*M	PKG 5M RKT 57x*M	PKG 5M WKT 57x*M
	4 PKW 5M		PKW 5M PKW 5M-57x	PKW 5M PSG 5M-57x	PKW 5M PSW 5M-57x	PKW 5M RST 57x*M	PKW 5M WST 57x*M	PKW 5M RKT 57x*M	PKW 5M WKT 57x*M
Picofast (Male)	1 PSG 5M			PSG 5M PSG 5M-57x	PSG 5M PSW 5M-57x	PSG 5M RST 57x*M	PSG 5M WST 57x*M	PSG 5M RKT 57x*M	PSG 5M WKT 57x*M
	2 PSW 5M				PSW 5M PSW 5M-57x	PSW 5M RST 57x*M	PSW 5M WST 57x*M	PSW 5M RKT 57x*M	PSW 5M WKT 57x*M

See pages M23 - M24 for dimensional drawings.

* Indicates length in meters.

x Indicates cable type. See page B125 for available cable types.

Standard cable lengths are 1, 2, 6, 8, 10, 15, and in +5 meter increments from there. Consult factory for other lengths.

For stainless steel coupling nuts change part number PSG 5M ... to PSGV 5M, PSW 5M ... to PSWV 5M.

We reserve the right to make technical alterations without prior notice.

DeviceNet™ Media

Picofast		Pinouts	Eurofast	
Male	Female		Male	Female
		1. Bare (Shield Drain Wire) 2. Red (+ Voltage) 3. Black (- Voltage) 4. White (CAN_H) 5. Blue (CAN_L)		

DeviceNet™ Physical Media Connectivity

DeviceNet, Cable/Cordsets Selection Matrix - Snap Lock

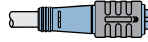
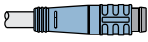
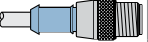
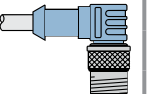
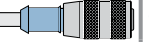
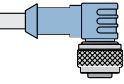
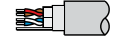
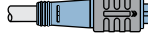
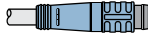
		Picofast®		Eurofast®			
		(Male)		(Female)		Male	Male
		 6 PKG 5Z	 5 PSG 5	 7 RST	 8 WST	 9 RKT	 10 WKT
 Bare		PKG 5Z 57x-*M	PSG 5 57x-*M	RST 57x-*	WST 57x-*	RKT 57x-*	WKT 57x-*
Picofast (Male) (5724 Cable Only)	 6 PKG 5Z	PKG 5Z PKGZ 5Z 57x-*M	PKG 5Z PSG 57x-*M	PKG 5Z RST 57x-*M	PKG 5Z WST 57x-*M	PKG 5Z RKT 57x-*M	PKG 5Z WKT 57x-*M
	 5 PSG 5		PSG 5 PSG 5 57x-*M	PSG 5 RST 57x-*M	PSG 5 WST 57x-*M	PSG 5 RKT 57x-*M	PSG 5 WKT 57x-*M

See pages M23 - M24 for dimensional drawings.

* Indicates length in meters.

x Indicates cable type. See page M20 for available cable types.

Standard cable lengths are 1, 2, 4, 5, 6, 8, 10, 15, and in +5 meter increments from there. Consult factory for other lengths.

We reserve the right to make technical alterations without prior notice.

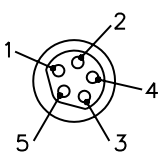
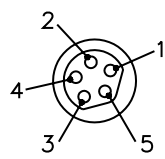
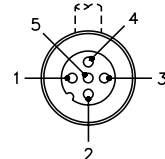
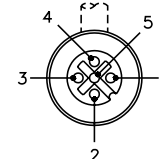
Picofast		Pinouts	Eurofast	
Male	Female		Male	Female
		1. Bare (Shield Drain Wire) 2. Red (+ Voltage) 3. Black (- Voltage) 4. White (CAN_H) 5. Blue (CAN_L)		

Specifications

Overmold:	TPU	Protection:	NEMA 1, 3, 4, 6P and IEC IP 67
Coupling Nut:	Nickel Plated CuZn or Stainless Steel (thread), Nylon (snap lock)	Rated Voltage:	30 V
Contact Carrier:	TPU or POM (Nylon)	Rated Current:	3 A
Contacts:	Gold Plated CuZn	Ambient Temperature:	-40 °C to +80 °C (-22 °F to +176 °F)

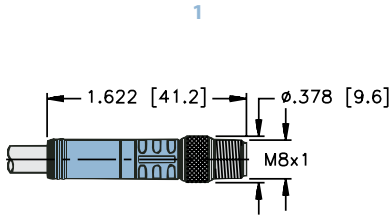

PSG 5M ..

Page M19

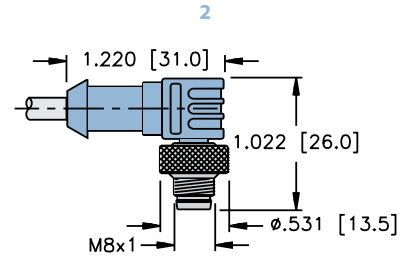

PSW 5M ..

Page M19

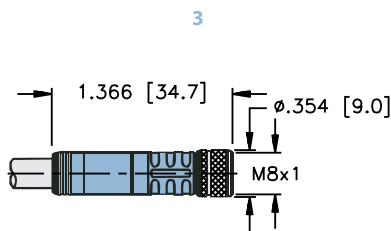

PKG 5M ..

Page M19

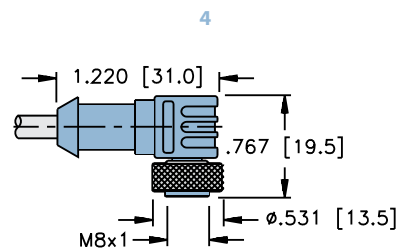

PKW 5M ..

Page M19

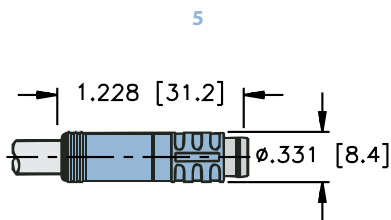

PSG 5 ..

Page M20

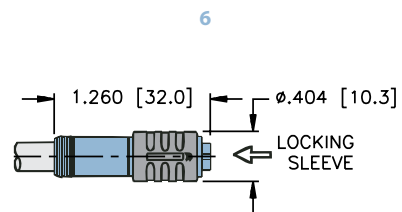

PKG 5Z ..

Page M20

We reserve the right to make technical alterations without prior notice.

DeviceNet™ Media

Specifications

Overmold:	TPU	Protection:	NEMA 1, 3, 4, 6P and IEC IP 68
Coupling Nut:	Nickel Plated CuZn or Stainless Steel	Rated Voltage:	250 V
Contact Carrier:	TPU	Rated Current:	4 A
Contacts:	Gold Plated CuZn	Ambient Temperature:	-40 °C to +80 °C (-22 °F to +176 °F)

7

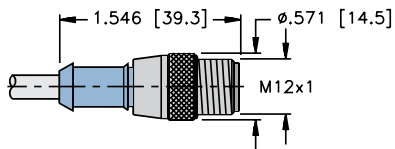

RST ..

Page M19

8

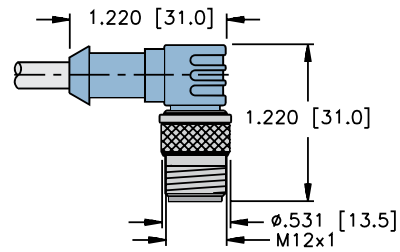

WST ..

Page M19

9

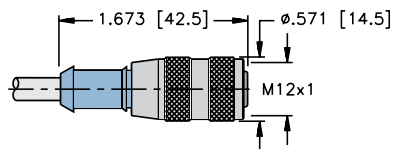

RKT ..

Page M19

10

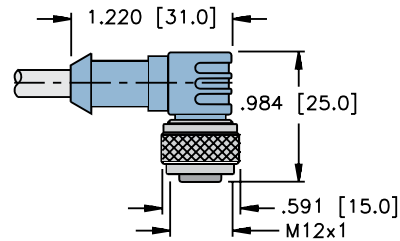

WKT ..

Page M19

We reserve the right to make technical alterations without prior notice.

DeviceNet, Terminating Resistors

- Terminating Resistors stabilize and minimize reflections on the Bus Line
- A Terminating Resistor is required at the beginning and end of the Main Bus Line



We reserve the right to make technical alterations without prior notice.

Housing Style	Part Number	Features	Pinout
	RSM 57-TR2	Nickel plated brass or stainless steel, 300 V (7.6 V max. on pins with resistor), -40 °C to +80 °C, IP 67, 120 Ohms, 1/2 W internal resistance	<p>Male</p>
	RKM 57-TR2	Nickel plated brass or stainless steel, 300 V (7.6 V max. on pins with resistor), -40 °C to +80 °C, IP 67, 120 Ohms, 1/2 W internal resistance	<p>Female</p>
	RSM 57-TR2/VM	Nickel plated brass or stainless steel, 24 V (7.6 V max. on pins with resistor), -40 °C to +80 °C, IP 67, 120 Ohms, 1/2 W internal resistance, voltage monitoring Led indication: Red - reverse polarity Green - okay	<p>Male</p>
	RSE 57-TR2	Nickel plated CuZn or stainless steel, 250 V (7.6 V max. on pins with resistor), 4 A, -40 °C to +80 °C, IP 68, 120 Ohms, 1/2 W internal resistance	<p>Male</p>
	RKE 57-TR2	Nickel plated CuZn or stainless steel, 250 V (7.6 V max. on pins with resistor), 4 A, -40 °C to +80 °C, IP 68, 120 Ohms, 1/2 W internal resistance	<p>Female</p>
	RSE 57-TR2/VM	Nickel plated CuZn or stainless steel, 10-30 VDC, -40 °C to +80 °C, IP 68, 120 Ohms, 1/2 W internal resistance, voltage monitoring Led indication: Red - reverse polarity Green - okay	<p>Female</p>

DeviceNet™ Media

DeviceNet™ Physical Media Connectivity

DeviceNet, Terminating Resistors

- Terminating Resistors stabilize and minimize reflections on the Bus Line
- A Terminating Resistor is required at the beginning and end of the Main Bus Line



Housing Style	Part Number	Features	Pinout
	PSG 5M 57-TR	Nickel plated brass or stainless steel, 125 V(7.6 V max on resistor), 2 A, -40 °C to +105 °C, IP 67, male Picofast® connector, 120 Ohms, 1/2 W internal resistance	Male
	PKG 5M 57-TR		Female

We reserve the right to make technical alterations without prior notice.

DeviceNet, Receptacles

- Receptacles provide transition from Male to Female Connectors
- Available for Bulkhead and Feed Through applications



Housing Style	Part Number	Features	Pinout
	RSF RKF 57/22	Straight male/female feed through, nickel plated CuZn or stainless steel, 300 V, 9 A, -40 °C to +75 °C, IP 67	
	FKM FS 57/M12	Straight male/female feed through, nickel plated CuZn or stainless steel, 150 V, 4 A, -40 °C to +75 °C, IP 67	

Standard housing material is nickel plated brass. "RSF RKF.."; "RSFV RKFV.." indicates stainless steel housing.

We reserve the right to make technical alterations without prior notice.

DeviceNet™ Media

**Panel Cutout
RSF RKF 57/22**

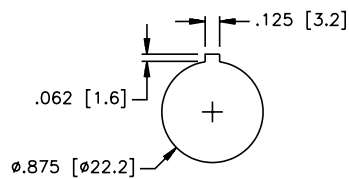

**Panel Cutout
FKM FS 57/M12**

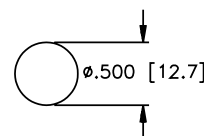

DeviceNet™ Physical Media Connectivity

DeviceNet, Eurofast® Drop Junctions

- Creates a Drop or Branch from the Main Bus Line
- Cable Drop Lengths available up to a maximum of 6 meters



Housing Style	Part Number	Features	Wiring Diagrams
	VB2-FKM/FKM/FSM 57	Ready for Eurofast drop and trunk cordsets, maximum six meter drop	
	VB2-RKC 57x-*/FKM FSM	Ready for Eurofast trunk line, maximum six meter drop	
	VB2-FKM/RKC RSC 57x-*M-*M	Ready for Eurofast drop cordsets, maximum six meter branch	

We reserve the right to make technical alterations without prior notice.

* Indicates length in meters.
 x Indicates cable type.

DeviceNet, Eurofast® Drop Junctions Dimensions

Specifications

Overmold:	TPU	Protection:	NEMA 1, 3, 4, 6P and IEC IP 67
Coupling Nut:	Nickel Plated CuZn or Stainless Steel	Rated Voltage:	250 V
Contact Carrier:	TPU or POM (Nylon)	Rated Current:	4 A
Contacts:	Gold Plated CuZn	Ambient Temperature:	-40 °C to +75 °C (32 °F to +167 °F)

Mounting: Mounting hole accepts #8 screw.

VB2-FKM/FKM/FSM 57

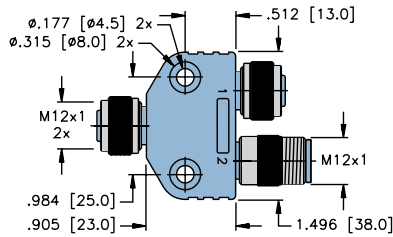

VB2-RKC 57x-*M-FKM FSM

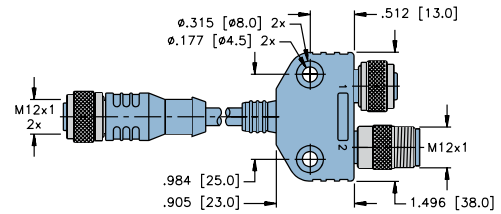

VB2-FKM/FKM/FSM 57

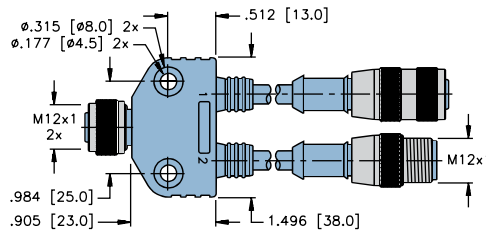

We reserve the right to make technical alterations without prior notice.

DeviceNet™ Media

Pinouts

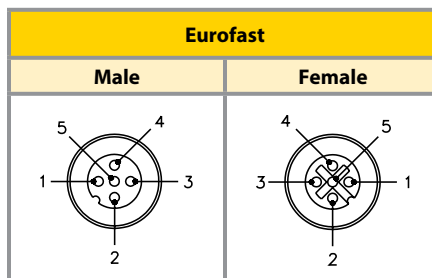

DeviceNet™ Physical Media Connectivity

DeviceNet, Bus Drop Tees

- Creates a Drop or Branch from the Main Bus Line
- (7/8-16 UN) Minifast® Connectors on Bus and Drop Lines
- Available in three Keyway options



Housing Style	Part Number	Features	Wiring Diagrams
	RSM-2RKM 57	TPU, 300 V, 9 A, -40 °C to +75 °C, maximum six meter branch, Standard keyway	
	RSM 2RKM 57-KF	TPU, 300 V, 9 A, -40 °C to +75 °C, maximum six meter branch, keyway facing female	
	RSM 2RKM 57-KM	TPU, 300 V, 9 A, -40 °C to +75 °C, maximum six meter branch, keyway facing male	

We reserve the right to make technical alterations without prior notice.

Pinouts

Minifast	
Male	Female

DeviceNet, Bus Drop and Diagnostic Tee

- Creates a Drop or Branch from the Main Bus Line
- (7/8-16 UN) Minifast® Connectors on Bus and Drop Lines
- Available in three Keyway options
- Different genders available
- LED Status Indicator



Housing Style	Part Number	Features	Wiring Diagrams
	SH-RKM/RSM/RKM 57-VM	TPU (Polyurethane), 30 V, 9 A, -40 °C to +105 °C, maximum six meter branch	
	RSM RSM 57-0/VM	TPU (Polyurethane), 30 V, 9 A, -40 °C to +105 °C, maximum six meter branch	
	RSM RKM 57-0/VM	TPU (Polyurethane), 30 V, 9 A, -40 °C to +105 °C, maximum six meter branch	
	RKM RKM 57-0/VM	TPU (Polyurethane), 30 V, 9 A, -40 °C to +105 °C	

We reserve the right to make technical alterations without prior notice.

DeviceNet™ Media

Pinouts

Minifast	
Male	Female

DeviceNet™ Physical Media Connectivity

DeviceNet, Bus Drop and Diagnostic Tee

- Creates a Drop or Branch from the Main Bus Line
- (7/8-16 UN) Minifast® Connectors on Bus and Drop Lines
- Available in three Keyway options
- Different genders available
- LED Status Indicator



Housing Style	Part Number	Features	Wiring Diagrams
	<p>MT-RKM/RSM/RKM 57/DNET/VM</p>	<p>TPU (Polyurethane), 30 V, 9 A, -40 °C to +105 °C</p>	
	<p>MT-RSM/2RKM 57/DNET/VM</p>	<p>TPU (Polyurethane), 30 V, 9 A, -40 °C to +105 °C</p>	

We reserve the right to make technical alterations without prior notice.

DeviceNet, Bus Drop Tee

- Creates a Drop or Branch from the Main Bus Line
- (7/8-16 UN) Minifast® Connectors on Bus and Drop Lines
- Available in three Keyway options
- Different genders available



Housing Style	Part Number	Features	Wiring Diagrams
	MT-RSM/2RKM 57/DNET		
	XSH-RKM/RSM/RKM 57		
	XSH-RSM-2RKM 57	TPU (Polyurethane), 30 V, 9 A, -40 °C to +105 °C	
	RSM RSM 57-0		
	RKM RKM 57-0		

We reserve the right to make technical alterations without prior notice.

DeviceNet™ Media

DeviceNet™ Physical Media Connectivity

DeviceNet, Power and Diagnostic Tees

- Provide a Drop to insert Power or Diagnostic Equipment
- (7/8-16 UN) Minifast® Connectors on Bus and Drop Lines
- Reverse Current Protection on Power Tap



Housing Style	Part Number	Features	Wiring Diagrams
	RSM RKM 57 WSM 40 PST	TPU, 300 V, 9 A, -40 °C to +75 °C, bus power tee provides segment power, includes reverse current protection	
	RSM-2RKM 57 DGT	TPU, 300 V, 9 A, -40 °C to +75 °C, bus diagnostic tee provides easy connection for diagnostic tools, tap protected with cover when not in use (not shown)	

We reserve the right to make technical alterations without prior notice.

Pinouts

Minifast	
Male	Female

DeviceNet, Bus Tees

- Creates a Drop or Branch from the Main Bus Line
- Cable Drop can be up to a maximum of 6 meters
- Eurofast® Drop Connector or Extension Cordset



Housing Style	Part Number	Features	Wiring Diagrams
	RSM FKM RKM 57	TPU, 250 V, 4 A, -40 °C to +75 °C, Minifast® to Eurofast bus power and data drop	
	RSM RKC 57x-M-RKM 57	TPU, 250 V, 4 A, -40 °C to +75 °C, Minifast to Eurofast cordset, bus power and data drop	

We reserve the right to make technical alterations without prior notice.

DeviceNet™ Media

Pinouts

Minifast		Eurofast
Male	Female	Female

DeviceNet™ Physical Media Connectivity

DeviceNet, Eurofast® Bus Tees

- Creates a Drop or Branch from the Main Bus Line
- Cable Drop can be up to a maximum of 6 meters
- Eurofast Drop Connector



Housing Style	Part Number	Features	Wiring Diagrams
	RSC 2RKC 57	TPU, 250 V, 4 A, -40 °C to +75 °C, Eurofast trunk and drop	
	RSC 2RKC 57/KS	TPU, 250 V, 4 A, -40 °C to +75 °C, Eurofast trunk and drop, keyway aligns tee in-line on (M8x1) Piconet® boxes	
	RSC RKC 572-*M/RKC 57	TPU, 32 V, 4 A (pins 2,3) 1 A (all others), -40 °C to +80 °C	

We reserve the right to make technical alterations without prior notice.

Pinouts

Eurofast	
Male	Female

DeviceNet, Gender Changers and Elbow Connectors

- Allows quick and easy changes from Male to Female Connectors
- Available in Straight and Right Angle Styles with Minifast® Connectors



Housing Style	Part Number	Features	Wiring Diagrams
	RSM RSM 57	TPU, 300 V, 9 A, -40 °C to +80 °C, changes female cordset to male cordset	
	RKM RKM 57	TPU, 300 V, 9 A, -40 °C to +80 °C, Changes male cordset to female cordset changes straight male or female cordset to right angle cordset	
	WSM RKM 57	TPU, 300 V, 9 A, -40 °C to +80 °C, right angle male to female connector	

We reserve the right to make technical alterations without prior notice.

DeviceNet™ Media

Pinouts

Minifast	
Male	Female

DeviceNet™ Physical Media Connectivity

DeviceNet, Gender Changers and Elbow Connectors

- Allows quick and easy changes from Male to Female and Minifast® to Eurofast® Connectors



Housing Style	Part Number	Features	Wiring Diagrams
	RSM 57-FK 4.5	Nickel plated CuZn or stainless steel, 250 V, 4 A, -40 °C to +75 °C, female Eurofast to male Minifast adapter	
	RSC RKC 57	Nickel plated CuZn, 250 V, 4 A, -40 °C to +105 °C, male Eurofast to female Eurofast adapter	
	RSC WKC 57		

We reserve the right to make technical alterations without prior notice.

Pinouts

Minifast	Eurofast	
Male	Male	Female

DeviceNet, (7/8-16 UN) Minifast® Male Receptacles

- Provides quick connection to Field Devices or Enclosures
- Available for 1/2-14 NPT, 1/2-14 NPSM, 3/4-14 NPT and M20 Threads



Housing Style	Female Part Number	Male Part Number	Features	Pinout
<p>RKF 57../14.5</p>	RKF 57-*M/14.5	RSF 57-*M/14.5	Nickel plated CuZn or stainless steel, 300 V, 9 A, -40 °C to +105 °C, 1/2-14 NPT full length threads	<p>Female</p>
<p>RSF 57../14.5</p>				
<p>RKF 57../14.75</p>	RKF 57-*M/14.75	RSF 57-*M/14.75	Nickel plated CuZn or stainless steel, 300 V, 9 A, -40 °C to +105 °C, 3/4-14 NPT full length threads	<p>Female</p>
<p>RSF 57../14.75</p>				
<p>RKF 57../M20</p>	RKF 57-*M/M20	RSF 57-*M/M20	Nickel plated CuZn or stainless steel, 300 V, 9 A, -40 °C to +105 °C, M20x1.5 threads	<p>Male</p>
<p>RSF 57../M20</p>				

We reserve the right to make technical alterations without prior notice.

DeviceNet™ Media

* Length in meters.
 Standard cable length is 0.5 meters. Consult factory for other lengths.
 Standard housing material is nickel plated brass. "RKF .."; "RKFV .." indicates 316 stainless steel housing.
 For locknuts to be included, add "W/LN" to the end of the part number.

DeviceNet™ Physical Media Connectivity

DeviceNet, (7/8-16 UN) Minifast® Male Receptacles

- Provides quick connection to Field Devices or Enclosures
- Available for 1/2-14 NPT, 1/2-14 NPSM, 3/4-14 NPT and M20 Threads



Housing Style	Female Part Number	Male Part Number	Features	Pinout
<p>RKF 57..</p>	RKF 57-*M	RSF 57-*M	Nickel plated CuZn or stainless steel, 300 V, 9 A, -40 °C to +105 °C, 1/2-14 NPSM threads	<p>Female</p>
<p>RSF 57..</p>				<p>Male</p>

* Length in meters.
 Standard cable length is 0.5 meters. Consult factory for other lengths.
 Standard housing material is nickel plated brass. "RKF .."; "RKFV .." indicates 316 stainless steel housing.
 For locknuts to be included, add "W/LN" to the end of the part number.

We reserve the right to make technical alterations without prior notice.

DeviceNet, (M12x1) Eurofast® Male Receptacles

- Provides quick connection to Field Devices
- Available for 1/2-14 NPT, 1/2-14 NPSM, 3/4-14 NPT and M20 Threads



Housing Style	Female Part Number	Male Part Number	Features	Pinout
<p>FK 57../14.5</p>	FK 57-*M/14.5	FS 57-*M/14.5	Nickel plated CuZn or stainless steel, 250 V, 4 A, -40 °C to +105 °C, 1/2-14 NPT full length threads	
<p>FS 57../14.5</p>				
<p>FK 57../14.75</p>	FK 57-*M/14.75	FS 57-*M/14.75	Nickel plated CuZn or stainless steel, 250 V, 4 A, -40 °C to +105 °C, 3/4-14 NPT full length threads	<ol style="list-style-type: none"> 1. GY 2. RD 3. BK 4. WH 5. BU
<p>FS 57../14.75</p>				
<p>FK 57.../M20</p>	FK 57-*M/M20	FS 57-*M/M20	Nickel plated CuZn or stainless steel, 250 V, 4 A, -40 °C to +105 °C, M20x1.5 threads	
<p>FS 57.../M20</p>				

We reserve the right to make technical alterations without prior notice.

DeviceNet™ Media

* Length in meters.
 Standard cable length is 0.5 meters. Consult factory for other lengths.
 Standard housing material is nickel plated brass. "RKF .."; "RKFV .." indicates 316 stainless steel housing.

DeviceNet™ Physical Media Connectivity

DeviceNet, (M12x1) Eurofast® Male Receptacles

- Provides quick connection to Field Devices
- Available for 1/2-14 NPT, 1/2-14 NPSM, 3/4-14 NPT and M20 Threads



Housing Style	Female Part Number	Male Part Number	Features	Pinout
<p>FK 57...</p> <p>FS 57..</p>	FK 57-*M	FS 57-*M	Nickel plated CuZn or stainless steel, 250 V, 4 A, -40 °C to +105 °C, PG 9 threads	<p>Female</p> <p>Male</p>

* Length in meters.
 Standard cable length is 0.5 meters. Consult factory for other lengths.
 Standard housing material is nickel plated brass. "RKF .."; "RKFV .." indicates 316 stainless steel housing.

We reserve the right to make technical alterations without prior notice.

DeviceNet, Minifast® PCB and Solder Cup Receptacles

- Provides (7/8-16 UN) Minifast connection to Field Devices



Housing Style	Female Part Number	Male Part Number	Features	Pinout
<p>RKF 57 PCB</p>	RKF 57-PCB	RSF 57-PCB	Nickel plated CuZn or stainless steel, 300 V, 9 A, -40 °C to +105 °C, Minifast PCB pins	<p>Female</p>
<p>RSF 57 PCB</p>				
<p>RKF 57</p>	RKF 57	RSF 57	Nickel plated CuZn or stainless steel, 300 V, 9 A, -40 °C to +105 °C, Minifast solder cups	<p>Male</p>
<p>RSF 57</p>				

We reserve the right to make technical alterations without prior notice.

DeviceNet™ Media

Standard housing material is nickel plated brass "RSFV .."; "RKFV .." indicates 316 stainless steel.

Board Layout (reference only) FK ... FS

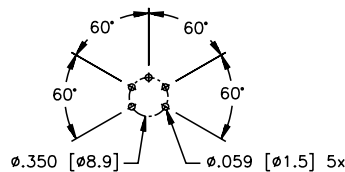

Panel Cutout FK ... FS

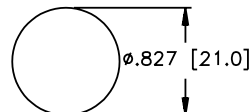

DeviceNet™ Physical Media Connectivity

DeviceNet, Eurofast® PCB and Solder Cup Receptacles

- Provides (M12x1) Eurofast Connection to Field Devices



Housing Style	Female Part Number	Male Part Number	Features	Pinout
<p>FK 57-PCB KIT</p>	FK 57-PCB KIT	FS 57-PCB KIT	Nickel plated CuZn or stainless steel, 250 V, 4 A, -40 °C to +105 °C, male Eurofast with mounting kit	<p>Male</p>
<p>FS 57-PCB KIT</p>				
<p>FS 57-PCB</p>	FK 57-PCB	FS 57-PCB	Nickel plated CuZn or stainless steel, 250 V, 4 A, -40 °C to +105 °C, male Eurofast	<p>Female</p>
<p>FK 57-PCB</p>				

We reserve the right to make technical alterations without prior notice.

Standard housing material is nickel plated brass "FSV .."; "FKV .." indicates 316 stainless steel.

Board Layout (reference only) FK ... FS

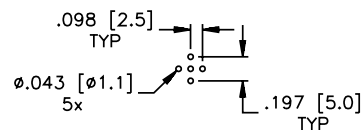

DeviceNet, Eurofast® PCB Pins and Solder Cup Receptacles

- Provides (M12x1) Eurofast Connection to Field Devices



Housing Style	Female Part Number	Male Part Number	Features	Pinout
<p>FKFD 57 PCB</p>	FKFD 57-PCB	FSFD 57-PCB	Nickel plated CuZn or stainless steel, 250 V, 4 A, -40 °C to +105 °C, male Eurofast PCB pins	<p>Female</p>
<p>FSFD 57 PCB</p>				
<p>FKFDL 57</p>	FKFDL 57	FSFDL 57	Nickel plated CuZn or stainless steel, 250 V, 4 A, -40 °C to +105 °C, male Eurofast solder cups	<ol style="list-style-type: none"> 1. BARE 2. RD 3. BK 4. WH 5. BU
<p>FSFDL 57</p>				
<p>WFS 57 PCB</p>		WFS 57-PCB	Nickel plated CuZn or stainless steel, 250 V, 4 A, -40 °C to +105 °C, male Eurofast right angle PCB pins	<p>Male</p>

We reserve the right to make technical alterations without prior notice.

DeviceNet™ Media

Standard housing material is nickel plated brass "FKFD ..."; "FKFDV ..." indicates 316 stainless steel.

Panel Cutout FKFD ... FSFD

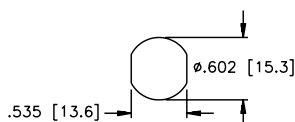

Board Layout (reference only) FKFD ... FSFD

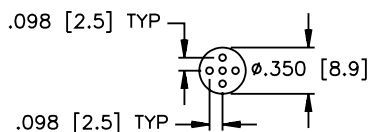

Panel Cutout WFS

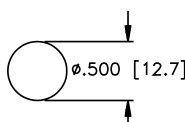

Board Layout (reference only) WFS

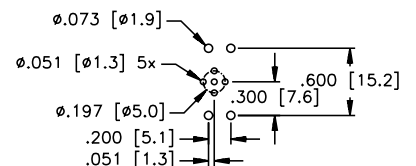

DeviceNet™ Physical Media Connectivity

DeviceNet, Minifast® Field Wireable Connectors

- Allows for quick connection when Pre-Molded Cables not available
- Available for Male and Female connectors
- Color Coded Wire Connections for DeviceNet



Housing Style	Female Part Number	Male Part Number	Features	Pinout
<p>B 4151..</p>	B 4151-0/9/DNET	BS 4151-0/9/DNET	Glass filled nylon, PG 9 cable gland, accepts 6-8 mm cable diameter, screw terminals, 85 °C, 250 V, 9 A, mates with all 5-pin cordsets and receptacles	<p>Female</p>
<p>BS 4151..</p>	B 4251-0/9/DNET	BS 4251-0/9/DNET	Glass filled nylon, PG 9 cable gland, accepts 6-8 mm cable diameter, screw terminals, 85 °C, 250 V, 9 A, mates with all 5-pin cordsets and receptacles	
<p>B 4251..</p>	B 4151-0/13.5/DNET	BS 4151-0/13.5/DNET	Glass filled nylon, PG 13.5 cable gland, accepts 10-12 mm cable diameter, screw terminals 85 °C, 250 V, 9 A, mates with all 5-pin cordsets and receptacles	<p>Male</p>
<p>BS 4251..</p>	B 4151-0/16/DNET	BS 4151-0/16/DNET	Glass filled nylon, PG 16 cable gland, accepts 12-14 mm cable diameter, screw terminals 85 °C, 250 V, 9 A, mates with all 5-pin cordsets and receptacles	

We reserve the right to make technical alterations without prior notice.

DeviceNet, Eurofast® Field Wireable Connectors

- Allows for quick connection when Pre-Molded Cables not available
- Available for Male and Female connectors in Straight or Right-Angle configurations
- Color Coded Wire Connections for DeviceNet



Housing Style	Female Part Number	Male Part Number	Features	Pinout	
<p>B 81...</p>	B 8151-0/PG9/DNET	BS 8151-0/PG9/DNET	PBT, Black, PG 9 cable gland, accepts 4-8 mm cable diameter, screw terminals, 85 °C, 125 V, 4 A, mates with 5-pin cordsets and receptacles	<p>Female</p>	
<p>BS 81...</p>					
<p>B 82...</p>	B 8251-0/PG9/DNET	BS 8251-0/PG9/DNET		PBT, Black, PG 9 cable gland, accepts 4-8 mm cable diameter, screw terminals, 85 °C, 125 V, 4 A, mates with 5-pin cordsets and receptacles	<p>Male</p>
<p>BS 82...</p>					

We reserve the right to make technical alterations without prior notice.

DeviceNet™ Media

DeviceNet™ Physical Media Connectivity

DeviceNet, Eurofast® Daisy Chain Configurations

- Multi-drop Harnesses designed for OEM applications
- Provides cost effective solution vs. Single Tees and Drops



Part Number	Features
FSFD 2VBWK WKC 5724-DCL	TPU, 250 V, 4 A, -40 °C to +75 °C, available in custom configurations including length, number of drops and end connector styles

Consult factory for other designs.

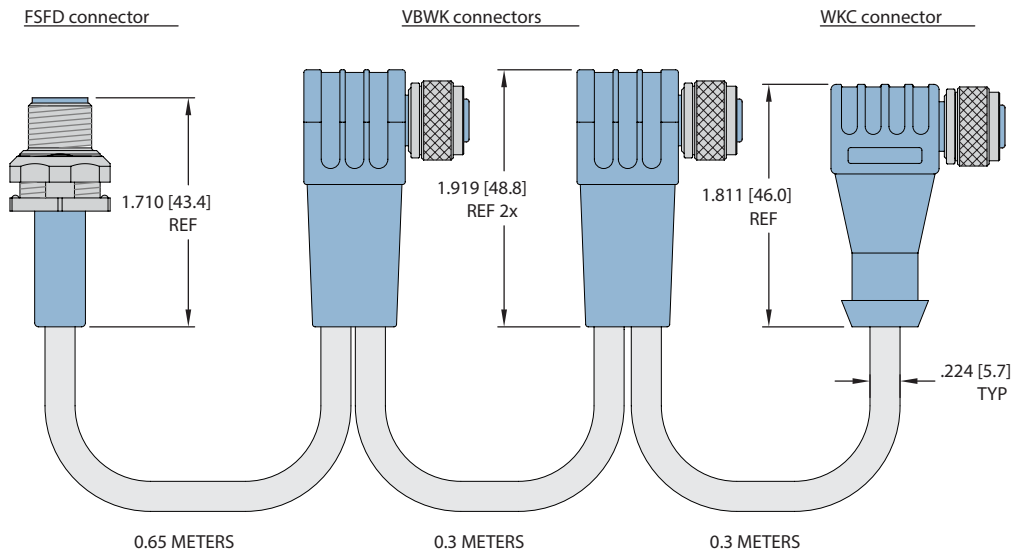

We reserve the right to make technical alterations without prior notice.

Pinouts

Eurofast	
Male	Female

DeviceNet, Eurofast® Daisy Chain Configurations

- Multi-drop Harnesses designed for OEM applications
- Provides cost effective solution vs. Single Tees and Drops



Part Number	Features
RSC 8VBRK RKC 5724-DCL	TPU, 250 V, 4 A, -40 °C to +75 °C, available in custom configurations including length, number of drops and end connector styles

Consult factory for other designs.

We reserve the right to make technical alterations without prior notice.

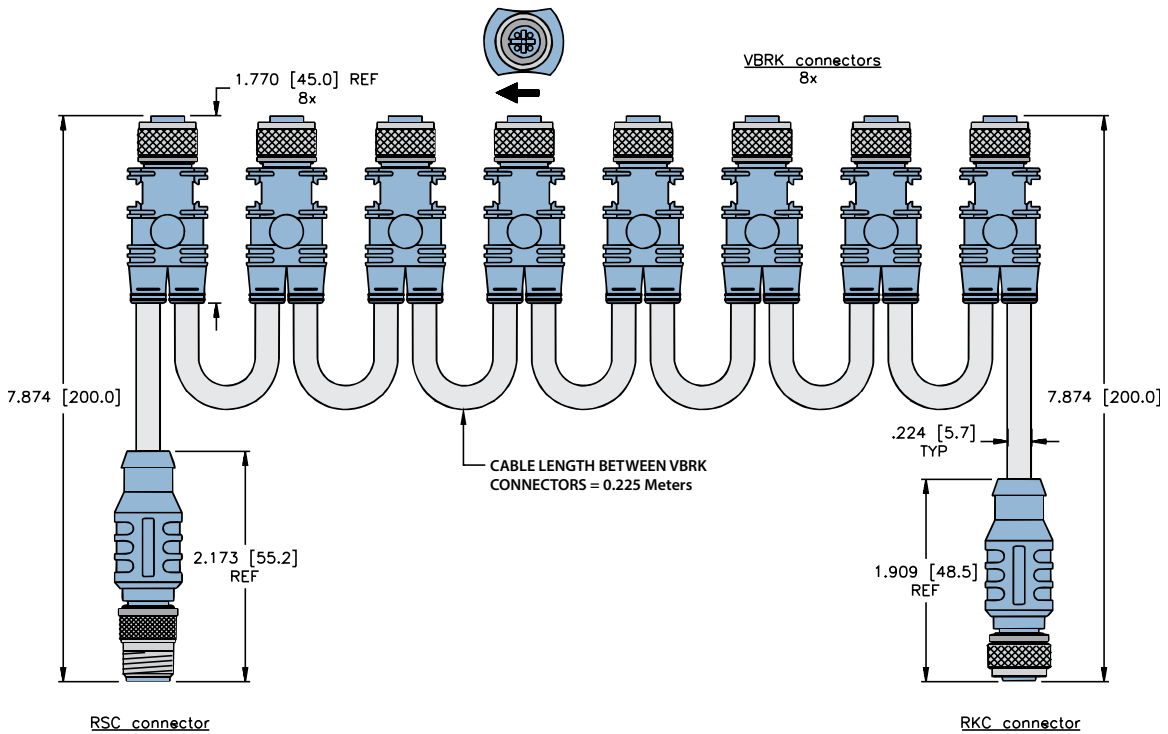

DeviceNet™ Media

Pinouts

Eurofast	
Male	Female

DeviceNet™ Physical Media Connectivity

Conduit Adapters

- Converts Standard Conduits to Quick Disconnect
- Fiberglass Reinforced Nylon Housings
- Nickel Plated Brass Connectors available
- Gasket and Mounting Screws provided
- IP67



Housing Style	1-Port Part Number	2-Port Part Number	Specifications	Pinout
	BCA-57-E123	BCA-57-E223	3/4" Form 8 or Mark 9 conduit to M12x1 adapter, -30 °C to +80 °C (-22 °F to +176 °F)	Female
	BCA-57-M123	BCA-57-M223	3/4" Form 8 or Mark 9 conduit to 7/8"-16 UN, -40 °C to +75 °C (-40 °F to +167 °F)	Female
	BCA1-F7-57-M123	BCA1-F7-57-M223	1" Form 7 conduit adapter, -40 °C to +75 °C (-40 °F to +167 °F)	Female

We reserve the right to make technical alterations without prior notice.

Wall Plate Adapters

- Attaches to Standard Single Gang Electrical Box
- Stainless Steel with Stainless Steel Connectors
- Gasket and Mounting Screws provided
- IP67



Housing Style	M12x1 Part Number	7/8-16UN Part Number	Specifications	Pinout
	BPA-57-E113	BPA-57-M113	IP67 rated, -40 °C to +75 °C (-40 °F to +167 °F)	Female
				Female

Part Number Keys	N4
Cordsets	N8
Tees	N13
Receptacles	N17
Field Wireables	N21

Features

- Cables that meet the requirements of Foundation fieldbus FF-844 Type A Cable
- ITC/PLTC listed cable (CSA FT4)
- Expose Run (ER) and Direct Buried (DB) listed cable
- Oil resistant II and sunlight resistant
- 7/8 and M12 connectors
- Up to 9 Amps and 600 Volt rated
- IP67/IP69K rated



FOUNDATION fieldbus General Specifications

FOUNDATION fieldbus is a communication protocol and physical method to interconnect smart devices such as temperature transmitters, pressure transmitters and valve actuators. The physical layer conforms to ISA SP50.02 and IEC 1158-2 standards for fieldbuses.

Fieldbus technology allows many smart devices to share one communication medium. The digital communication signal is superimposed onto a DC carrier. This reduces the amount of terminations to connect all the field devices to a host system and allows greater flexibility for future additions of I/O points.

A FOUNDATION fieldbus device is addressable and can store and transmit data. The devices can store values, track changes and use pre-set alarms to trigger. Based on pre-defined tag names, host systems can read transmitter values such as temperature and pressure to set values of a valve actuator.

Digital signal encoding is done using Manchester BiPhase-L and error checking is done with the CRC method. FOUNDATION fieldbus has two types of devices - A Basic Device (BD) which reads inputs, track values and set outputs if programmed to do so, and a Link Active Scheduler (LAS) which performs the same features as a BD and handles network communication timing between all the active devices on the network.

Topology

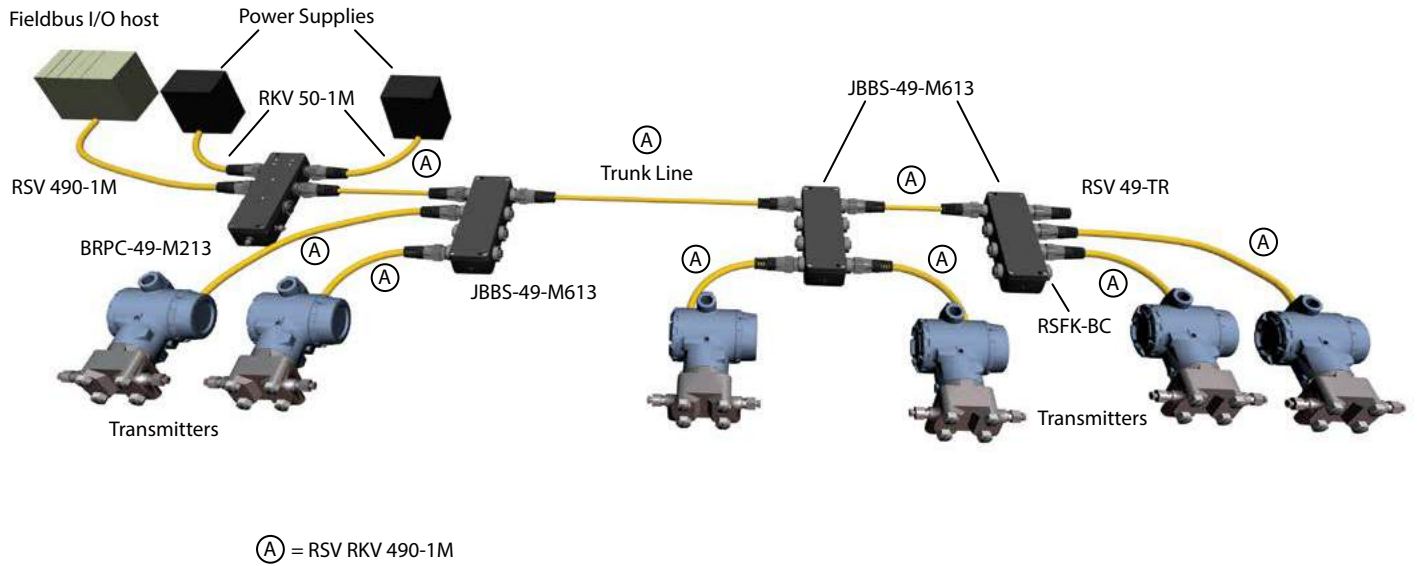

FOUNDATION™ fieldbus Physical Media Connectivity

Minifast® Cordset Part Number Key

Part Number Keys are to assist in IDENTIFICATION ONLY. Consult factory for catalog items not identified.

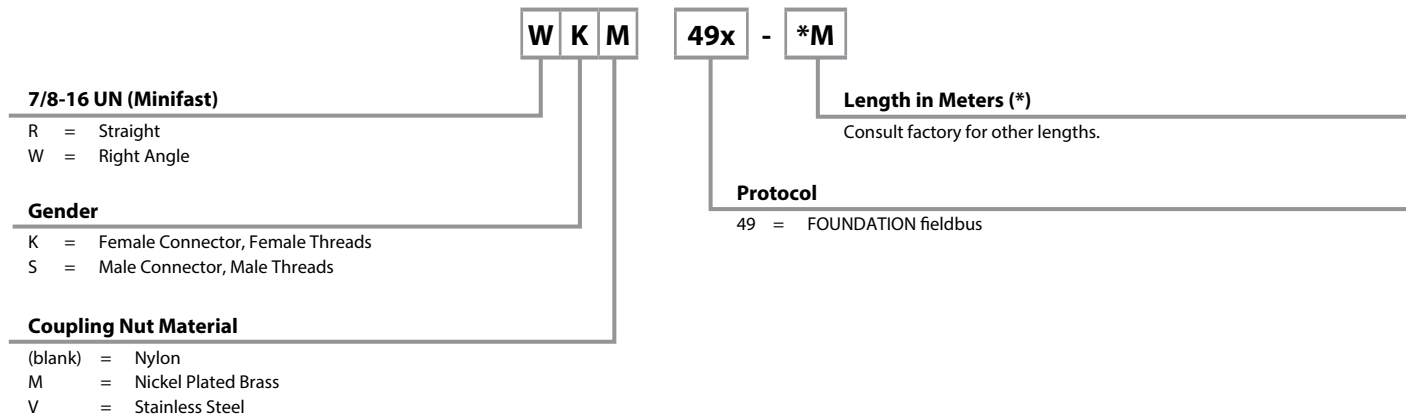

Minifast Receptacle Part Number Key

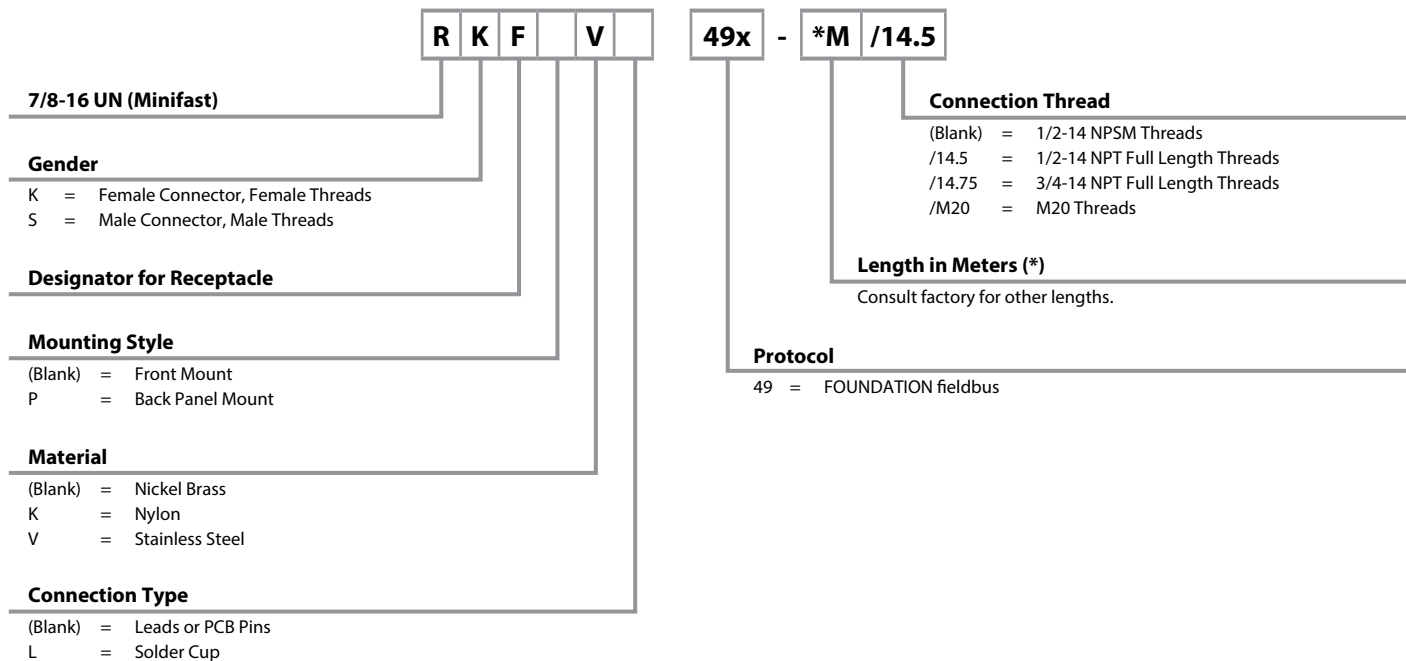

Eurofast® Cordset Part Number Key

Part Number Keys are to assist in IDENTIFICATION ONLY. Consult factory for catalog items not identified.

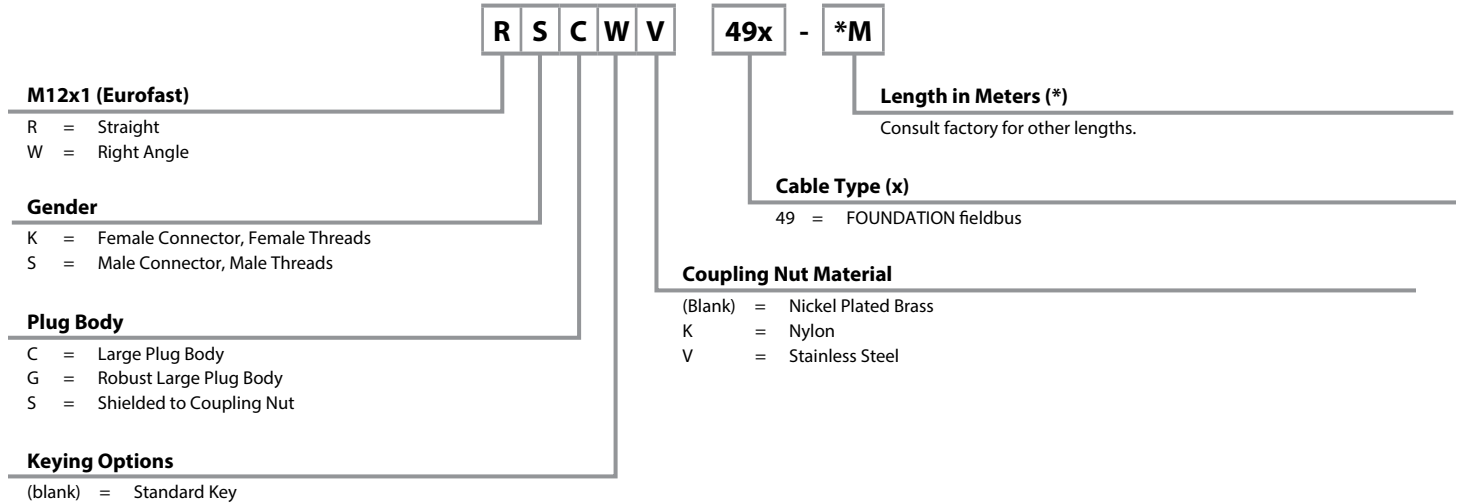

Eurofast Receptacle Part Number Key

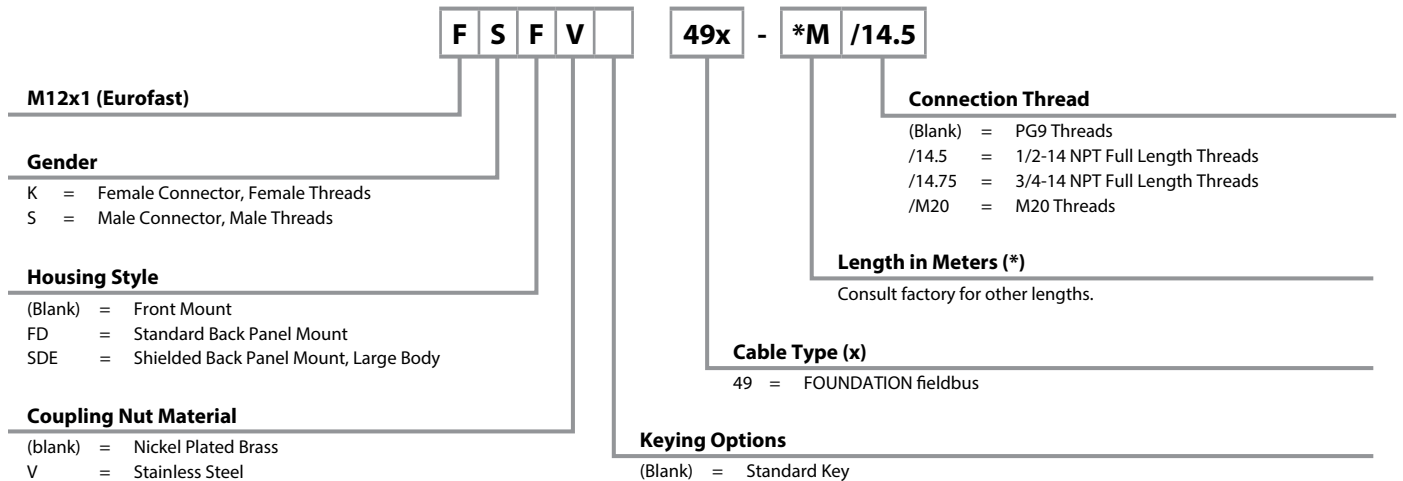

FOUNDATION™ fieldbus Physical Media Connectivity

Cable Specifications (with ground)

- Cables are compliant with FOUNDATION fieldbus FF-844 Cable Specification for Type A cable, IEC 61158-2 and ISA/SP50
- Cables are available in 3-wire versions with a Device Ground or 2-wire versions

Type A Cable Specifications

- Temperature range: -40 °C to +105 °C
- UV Resistant and Oil Resistant
- PLTC and ITC Listed (CSA FT1, FT4)
- Exposed Run (ER) and Direct Buried (DB) Listed
- Maximum Attenuation at 1.25 f_r (39 kHz) = 3.0 dB/km
- Characteristic Impedance 100 Ω ± 10 Ω @ 31.25 KHz
- Capacitance: 20 pF/Ft nominal
- Inductance: 0.22 μH/Ft. nominal

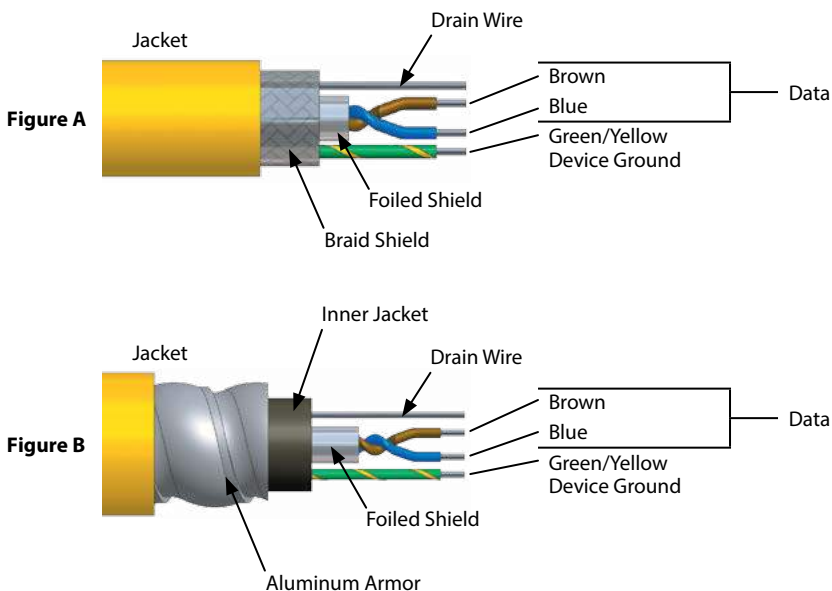

Type	Approvals	Data Pair		Device Ground	Outer Jacket	Shields	Bulk Cable Part Number / Weight/300 M
		AWG Color Code	DCR (/1000 feet) Insulation	AWG Color Code	Material Color Nominal O.D.	Type Drain Wire	
490 105 °C, 600 V	c(UL) 1309 MS, ITC-ER DB, CIC/TC, FT1 FT4	2X18 AWG BU/BN	7.06 Ohms XLPE	18 AWG, GN-YE	PVC, YELLOW, 8.4 mm (.330 in)	Foil, 20 AWG	RB50693-*M, 66 lbs.
490B 105 °C, 600 V	c(UL) 1309 MS, ITC-ER DB, CIC/TC, FT1 FT4	2X18 AWG BU/BN	7.06 Ohms XLPE	18 AWG, GN-YE	PVC, BLUE, 8.4 mm (.330 in)	Foil, 20 AWG	B50783-*M, 66 lbs.
492A 105 °C, 300 V	UL ITC-ER DB, CSA ACIC HL-ABCD, FT1 FT4	2X18 AWG BU/BN	7.06 Ohms XLPE	18 AWG, GN-YE	PVC, YELLOW, 15.6 mm (.615 in)	Foil/armor, 20 AWG	RB50874-*M, 184 lbs.
492BA 105 °C, 300 V	UL ITC-ER DB, CSA ACIC HL-ABCD, FT1 FT4	2X18 AWG BU/BN	7.06 Ohms XLPE	18 AWG, GN-YE	PVC, BLUE, 15.6 mm (.615 in)	Foil/armor, 20 AWG	RB50803-*M, 184 lbs.

* Indicates length in meters.
Standard cable spool lengths are 30, 75, 100, 150, 200, 225 and 300 meters.

We reserve the right to make technical alterations without prior notice.

Cable Specifications (without ground)

- Cable that Meets the Requirements of ISA/SP50 and FOUNDATION™ fieldbus Requirements for Type A Cable
- Cables are available in 3-wire versions with a Device Ground or 2-wire versions

Type A Cable Specifications

- Temperature range: -40 °C to +105 °C
- UV Resistant and Oil Resistant
- PLTC and ITC Listed (CSA FT1, FT4)
- Exposed Run (ER) and Direct Buried (DB) Listed
- Maximum Attenuation at 1.25 f, (39 kHz) = 3.0 dB/km
- Characteristic Impedence 100 Ω ± 10 Ω @ 31.25 KHz
- Capacitance: 20 pF/Ft nominal
- Inductance: 0.22 μH/Ft. nominal

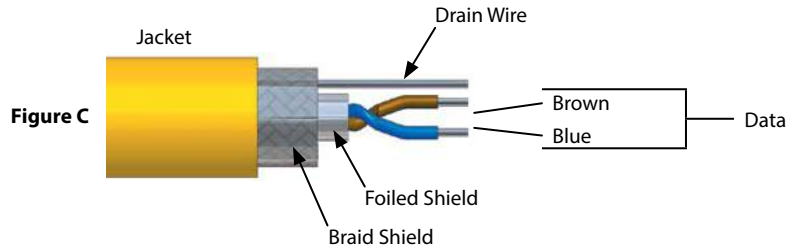

We reserve the right to make technical alterations without prior notice.







Type	Approvals	Data Pair		Outer Jacket Material Color Nominal O.D.	Shields Type Drain Wire	Bulk Cable Part Number/ Weight/300 M
		AWG Color Code	DCR (/1000 feet) Insulation			
493 105 °C, 600 V	c(UL) 1309 MS, ITC-ER DB, CIC/TC, FT1 FT4	2X18 AWG BU/BN	7.06 Ohms XLPE	PVC, YELLOW, 8.5 mm (.335 in)	Foil/braid, 20 AWG	RB50784-*M, 66 lbs.
493B 105 °C, 600 V	c(UL) 1309 MS, ITC-ER DB, CIC/TC, FT1 FT4	2X18 AWG BU/BN	7.06 Ohms XLPE	PVC, BLUE, 8.5 mm (.335 in)	Foil/braid, 20 AWG	RB50786-*M, 66 lbs.
493O 105 °C, 600 V	c(UL) 1309 MS, ITC-ER DB, CIC/TC, FT1 FT4	2X18 AWG BU/BN	7.06 Ohms XLPE	PVC, ORANGE, 8.5 mm (.335 in)	Foil/braid, 20 AWG	RB50785-*M, 66 lbs.
496 105 °C, 600 V	c(UL) 1309 MS, ITC-ER DB, CIC/TC, FT1 FT4	2X16 AWG BU/BN	4.05 Ohms XLPE	PVC, YELLOW, 9.1 mm (.360 in)	Foil, 18 AWG	RB50891-*M, 69 lbs.
496BK 105 °C, 600 V	c(UL) 1309 MS, ITC-ER DB, CIC/TC, FT1 FT4	2X16 AWG BU/BN	4.05 Ohms XLPE	PVC, BLACK, 9.1 mm (.360 in)	Foil, 18 AWG	RB51300-*M, 69 lbs.

* Indicates length in meters.
Standard cable pool lengths are 30, 75, 100, 150, 200, 225 and 300 meters.

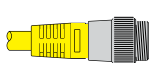
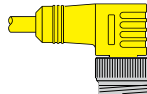
FOUNDATION™ fieldbus

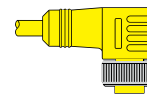
FOUNDATION™ fieldbus Physical Media Connectivity

Cable and Cordset Selection Matrix

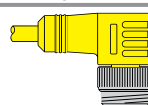
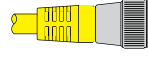
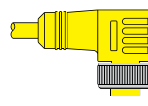
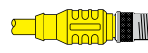
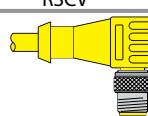
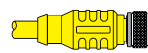
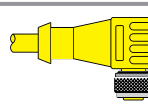
		Minifast®				Eurofast®
		(Male)		(Female)		Male
		1  RSV	2  WSV	3  RKV	4  WKV	7  RSCV
	 Bare	RSV 49x-*M	WSV 49x-*M	RKV 49x-*M	WKV 49x-*M	RSCV 49x-*M
Minifast (Male)	1  RSV	RSV RSV 49x-*M	RSV WSV 49x-*M	RSV RKV 49x-*M	RSV WKV 49x-*M	RSV RSCV 49x-*M
	2  WSV		WSV WSV 49x-*M	WSV RKV 49x-*M	WSV WKV 49x-*M	WSV RSCV 49x-*M
Minifast (Female)	3  RKV			RKV RKV 49x-*M	RKV WKV 49x-*M	RKV RSCV 49x-*M
	4  WKV				WKV WKV 49x-*M	WKV RSCV 49x-*M
Eurofast (Male)	7  RSCV					RSCV RSCV 49x-*M
	8  WSCV					
Eurofast (Female)	9  RKCV					
	10  WKCV					

We reserve the right to make technical alterations without prior notice.

See pages N10 - N11 for dimensional drawings.

* Indicates length in meters.

x Indicates cable type.

Standard cable lengths are 1, 2, 4, 6, 8, 10, 15...50 Meters. Consult factory for other lengths.

For stainless steel coupling nuts change part number RSM ... to RSV, WSM ... to WSV.

Cable and Cordset Selection Matrix

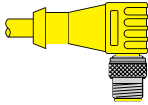
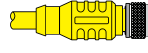
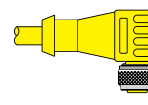
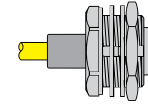
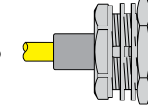
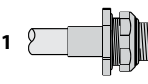
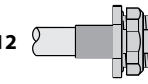
Eurofast®			Minifast® Bulkhead		Eurofast Bulkhead	
Male	Female		Male	Female	Male	Female
8 	9 	10 	5 	6 	11 	12 
WSCV	RKCV	WKCV	RSFPV	RKFPV	FSFDV	FKFDV
WSCV 49x-*M	RKCV 49x-*M	WKCV 49x-*M	RSFPV 49x-*M	RKFPV 49x-*M	FSFDV 49x-*M	FKFDV 49x-*M
RSV WSCV 49x-*M	RSV RKCV 49x-*M	RSV WKCV 49x-*M	RSV RSFPV 49x-*M	RSV RKFPV 49x-*M	RSV FSFDV 49x-*M	RSV FKFDV 49x-*M
WSV WSCV 49x-*M	WSV RKCV 49x-*M	WSV WKCV 49x-*M	WSV RSFPV 49x-*M	WSV RKFPV 49x-*M	WSV FSFDV 49x-*M	WSV FKFDV 49x-*M
RKV WSCV 49x-*M	RKV RKCV 49x-*M	RKV WKCV 49x-*M	RKV RSFPV 49x-*M	RKV RKFPV 49x-*M	RKV FSFDV 49x-*M	RKV FKFDV 49x-*M
WKV WSCV 49x-*M	WKV RKCV 49x-*M	WKV WKCV 49x-*M	WKV RSFPV 49x-*M	WKV RKFPV 49x-*M	WKV FSFDV 49x-*M	WKV FKFDV 49x-*M
RSCV WSCV 49x-*M	RSCV RKCV 49x-*M	RSCV WKCV 49x-*M	RSCV RSFPV 49x-*M	RSCV RKFPV 49x-*M	RSCV FSFDV 49x-*M	RSCV FKFDV 49x-*M
WSCV WSCV 49x-*M	WSCV RKCV 49x-*M	WSCV WKCV 49x-*M	WSCV RSFPV 49x-*M	WSCV RKFPV 49x-*M	WSCV FSFDV 49x-*M	WSCV FKFDV 49x-*M
	RKCV RKCV 49x-*M	RKCV WKCV 49x-*M	RKCV RSFPV 49x-*M	RKCV RKFPV 49x-*M	RKCV FSFDV 49x-*M	RKCV FKFDV 49x-*M
		WKCV WKCV 49x-*M	WKCV RSFPV 49x-*M	WKCV RKFPV 49x-*M	WKCV FSFDV 49x-*M	

We reserve the right to make technical alterations without prior notice.

FOUNDATION™ fieldbus

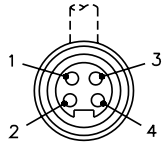
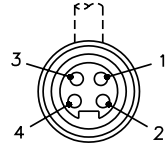
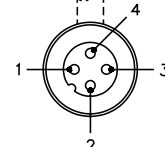
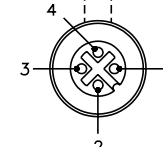
Minifast		Pinouts	Eurofast	
Male	Female		Male	Female
		1. Blue (- Voltage) 2. Brown (+ Voltage) 3. Bare (Shield Drain Wire) 4. Green/Yellow (Ground)		

FOUNDATION™ fieldbus Physical Media Connectivity

Cordset and Receptacle Connector Dimensions

Specifications

Overmold:	TPU	Protection:	NEMA 1, 3, 4, 6P and IEC IP 68
Coupling Nut:	Nickel Plated CuZn or Stainless Steel	Rated Voltage:	300 V
Contact Carrier:	TPU	Rated Current:	9 A
Contacts:	Gold Plated CuZn	Ambient Temperature:	-40 °C to +105 °C (-40 °F to +221°F)

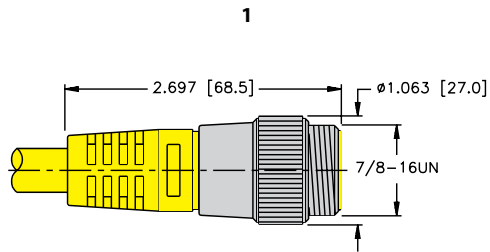

RSV ..

Page N8

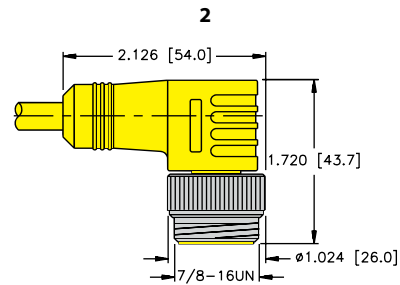

WSV ..

Page N8

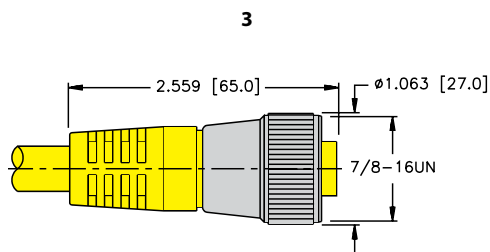

RKV ..

Page N8

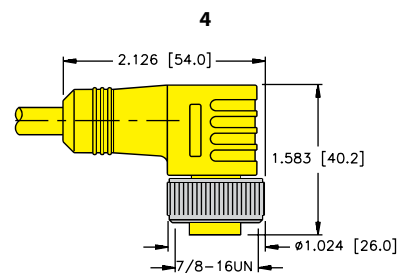

WKV ..

Page N8

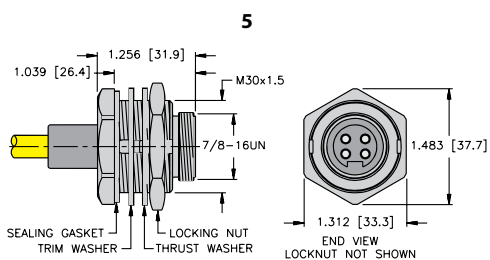

RSFPV ..

Page N9

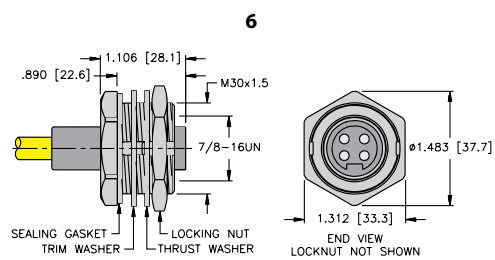

RKFPV ..

Page N9

We reserve the right to make technical alterations without prior notice.

Cordset and Receptacle Connector Dimensions

Specifications

Overmold:	TPU	Protection:	NEMA 1, 3, 4, 6P and IEC IP 68
Coupling Nut:	Nickel Plated CuZn or Stainless Steel	Rated Voltage:	250 V
Contact Carrier:	TPU or POM (Nylon)	Rated Current:	4 A
Contacts:	Gold Plated CuZn	Ambient Temperature:	-40 °C to +105 °C (-40 °F to +221°F)

7

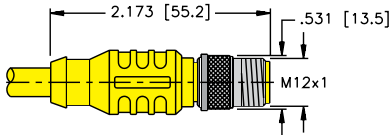

RSCV ..

Page N8

8

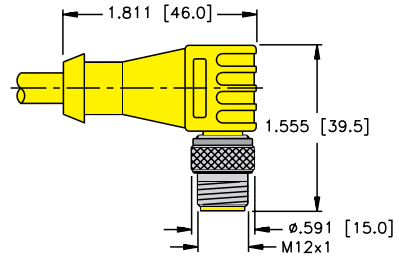

WSCV ..

Page N8

9

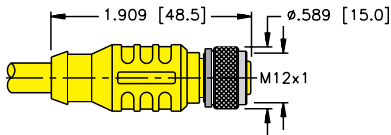

RKCV ..

Page N8

10

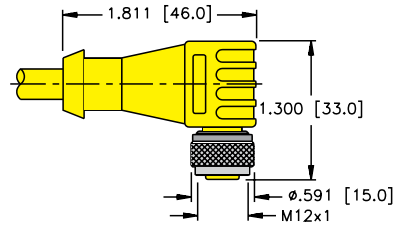

WKCV ..

Page N8

11

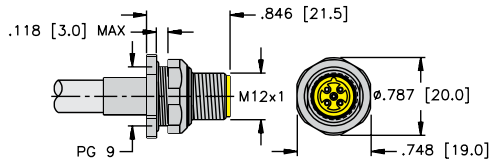

FSFDV ..

Page N9

12

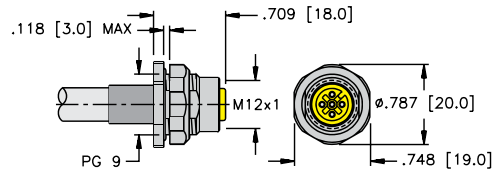

FKFDV ..

Page N9

We reserve the right to make technical alterations without prior notice.

FOUNDATION™ fieldbus

FOUNDATION™ fieldbus Physical Media Connectivity

Eurofast® Heavy Duty Cordsets

- Heavy Duty Coupling Nut completely supports the Molded Plug Body
- Provides superior strength



Housing Style	Female Part Number	Female Part Number	Features	Pinout
<p>RKGV..</p> <p>RSGV..</p>	RKGV-49x-*M	RSGV-49x-*M	TPU Nickel plated CuZn or stainless steel, 250 V, 4 A, -40 °C to +105 °C, heavy coupling nut completely supports the molded plug body to provide superior strength	<p>Female</p> <p>Male</p>

* Indicates length in meters.

x Indicates cable type.

For nickel plated brass coupling nut change: RSGV ... to RSG ... or RKGV ... to RKG ...

We reserve the right to make technical alterations without prior notice.

Terminating Resistors

- Terminating Resistors stabilize and minimize Reflections on the Bus Line
- A Terminating Resistor is required at the beginning and end of the Main Bus Line



Housing Style	Part Number	Features	Pinout
	RSV 49-TR	Nickel plated brass or stainless steel, 250 V, 4 A, -40 °C to +75 °C, male Minifast® connector	<p>Male</p>
	RSEV 49-TR	Nickel plated brass or stainless steel, 250 V, 4 A, -40 °C to +75 °C, male Eurofast connector	<p>Male</p>

Tees

- Creates a Drop or Branch from the Main Bus Line
- Minifast® Connectors on Bus Line
- Minifast or Eurofast® Connectors on Dropline



We reserve the right to make technical alterations without prior notice.

Housing Style	Part Number	Features	Wiring Diagrams
	RSV-2RKV 49	TPU, 250 V, 4 A, -40 °C to +75 °C, data, ground, shield stainless steel coupling nuts	
	RSV FKV RKV 49	TPU, 250 V, 4 A, -40 °C to +75 °C, data, ground, shield stainless steel coupling nuts	
	RSCV 2RKCV 49	TPU, 250 V, 4 A, -40 °C to +75 °C, stainless steel coupling nuts	
	RSCV WKCV 49	TPU, 250 V, 4 A, -40 °C to +75 °C, stainless steel coupling nuts	
	RSCV RKCVCV 49	TPU, 250 V, 4 A, -40 °C to +75 °C, stainless steel coupling nuts	

FOUNDATION™ fieldbus

Pinouts

Minifast		Eurofast	
Male	Female	Male	Female

FOUNDATION™ fieldbus Physical Media Connectivity

Gender Changers and Elbow Connectors

- Allows quick and easy changes from Male to Female Minifast® Connectors



Housing Style	Part Number	Specs	Application	Wiring Diagrams
	RSV RSV 49		Male Minifast Gender Changer • Changes female cordset to male receptacle	
	RKV RKV 49	TPU 250 V, 4 A -40 °C to +75 °C	Female Minifast Gender Changer • Changes female cordset to male receptacle	
	WSV RKV 49		Minifast Elbow • Right angle male to female connector	

We reserve the right to make technical alterations without prior notice.

Pinouts

Minifast	
Male	Female

Surge Suppressor

- Protects Data Communication Lines (V+ and V-)
- Absorbs the front end of the Transient, responding in less than a Nanosecond
- Diverts the Surge Energy to Ground



Housing	Part Number	Features	Application	Pinout
See Drawing 1	RSV RKV 49 SS	<p>Electrical</p> <p>Contact Carrier Material Thermoplastic Polyurethane</p> <p>Mold Material/Color Thermoplastic Polyurethane/Yellow</p> <p>Contact Material/Plating Gold-Plated Brass</p> <p>Coupling Nut Material Stainless Steel</p> <p>Max. Operating Voltage 36 VDC</p> <p>Max. Operating Current 600 mA</p> <p>Max. Clamping Voltage 58 V</p> <p>Surge Current (8/20µs ≤5 shots) 20kA</p> <p>Temperature Rating -40 °C to +85 °C</p> <p>Protection Class (VDE 0110 b) Meets NEMA 1,3,4,6,13</p> <p>Insulation Resistance ≥40 MΩ</p> <p>Capacitance Between V+, V- at 24 V ... 0.4nF</p> <p>Mechanical</p> <ul style="list-style-type: none"> • Ground Stud: 10-32 stainless steel • Operating temperature: -40 °C to +85 °C 	Male and Female Minifast®, 4-pin	<p>Female</p> <p>Female</p>

We reserve the right to make technical alterations without prior notice.

FOUNDATION™ fieldbus

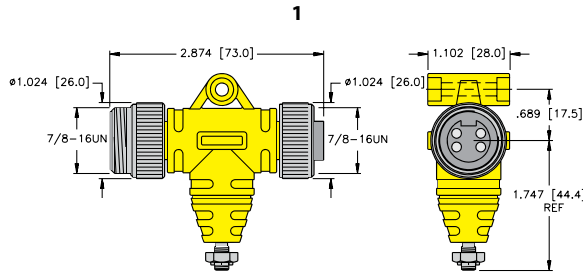

FOUNDATION™ fieldbus Physical Media Connectivity

Feed Through Connectors

- Receptacles provide transition from Male to Female Connectors
- Available for Bulkhead and Feed Through applications



Housing Style	Part Number	Features	Pinout
	RSFV RKFV 49/22	Stainless steel, 300 V, 9 A, -40 °C to +75 °C, straight male/female feed-through, for use with Minifast® cordsets	<p>Female</p> <p>Male</p>
	FKV FSV 49/M12	Stainless steel, 250 V, 4 A, -40 °C to +75 °C, straight male/female connector, for use with Eurofast® cordsets	<p>Female</p> <p>Male</p>

We reserve the right to make technical alterations without prior notice.

Standard housing material is nickel plated brass. "RSF RKF .."; "RSFV RKFV .." indicates stainless steel housing.

Panel Cutout RSFV RKFV 48/22

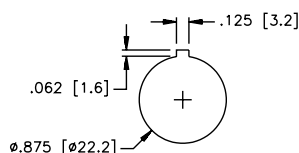

Panel Cutout WFS

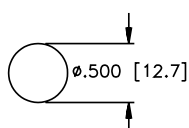

(7/8-16 UN) Minifast® Receptacles

- Provides quick connection to Field Devices
- available for 1/2-14 NPT, 1/2-14 NPSM, 3/4-14 NPT and M20 Threads



We reserve the right to make technical alterations without prior notice.

Housing Style	Female Part Number	Male Part Number	Features	Pinout
<p>RKFV../14.5</p>	RKFV 49-*M/14.5	RSFV 49-*M/14.5	Nickel plated CuZn or stainless steel, 300 V, 9 A, -40 °C to +105 °C, 1/2-14 NPT full length threads	<p>Female</p>
<p>RSFV../14.5</p>				
<p>RKFV../14.75</p>	RKFV 49-*M/14.75	RSFV 49-*M/14.75	Nickel plated CuZn or stainless steel, 300 V, 9 A, -40 °C to +105 °C, 3/4-14 NPT full length threads	<p>Male</p>
<p>RSFV../14.75</p>				
<p>RKFV..*M20</p>	RKFV 49-*M/M20	RSFV 49-*M/M20	Nickel plated CuZn or stainless steel, 300 V, 9 A, -40 °C to +105 °C, M20x1.5 threads	<p>Male</p>
<p>RSFV..*M20</p>				

Standard cable length is 0.5 meters. Consult factory for other lengths.
 Standard housing material is nickel plated brass housing. "RKF .."; "RKFV .." indicates 316 stainless steel.
 For locknuts to be included, add "W/LN" to the end of the part number.

FOUNDATION™ fieldbus Physical Media Connectivity

(7/8-16 UN) Minifast® Receptacles

- Provides quick connection to Field Devices
- Available for 1/2-14 NPT, 1/2-14 NPSM, 3/4-14 NPT and M20 Threads



Housing Style	Female Part Number	Male Part Number	Features	Pinout
<p>RKFV..*M</p>	RKFV 49-*M	RSFV 49-*M	Nickel plated CuZn or stainless steel, 300 V, 9 A, -40 °C to +105 °C, 1/2-14 NPSM threads	<p>Female</p>
<p>RSFV..*M</p>				<p>Male</p>

Standard cable length is 0.5 meters. Consult factory for other lengths.
 Standard housing material is nickel plated brass housing. "RKF .."; "RKFV .." indicates 316 stainless steel.
 For locknuts to be included, add "W/LN" to the end of the part number.

We reserve the right to make technical alterations without prior notice.

Male End View

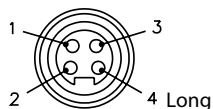

- 1 = BU (-voltage)
- 2 = BN (+ voltage)
- 3 = N/C
- 4 = GN/YE (ground)

49 Series

Male End View

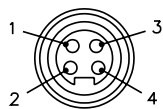

- 1 = BU
- 2 = BN
- 3 = N/C
- 4 = N/C

49T Series

Male End View

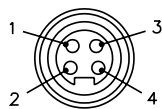

- 1 = BU (-voltage)
- 2 = BN (+ voltage)
- 3 = GY
- 4 = N/C

49D Series

Male End View

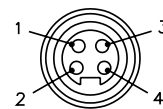

- 1 = BU (-voltage)
- 2 = BN (+ voltage)
- 3 = GY
- 4 = GN/YE (ground)

49E Series

(M12x1) Eurofast® Female Receptacles

- Mounted for quick connection to Enclosures
- Available for 1/2-14 NPT, 1/2-14 NPSM, 3/4-14 NPT and M20 Threads



We reserve the right to make technical alterations without prior notice.

Housing Style	Female Part Number	Male Part Number	Features	Pinout	
<p>FKV../14.5</p>	FKV 49-*M/14.5	FSV 49-*M/14.5	Nickel plated CuZn or stainless steel, 250 V, 4 A, -40 °C to +105 °C, 1/2-14 NPT full length threads	<p style="text-align: center;">Female</p>	
<p>FSV../14.5</p>					
<p>FKV../14.75</p>	FKV 49-*M/14.75	FSV 49-*M/14.75	Nickel plated CuZn or stainless steel, 250 V, 4 A, -40 °C to +105 °C, 3/4-14 NPT full length threads		
<p>FSV../14.75</p>					
<p>FKV../M20</p>	FKV 49-*M/M20	FSV 49-*M/M20	Nickel plated CuZn or stainless steel, 250 V, 4 A, -40 °C to +105 °C, M20x1.5 Threads		<p style="text-align: center;">Male</p>
<p>FKV../M20</p>					

Standard cable length is 0.5 meters. Consult factory for other lengths.
 Standard housing material is stainless steel. "RKF .."; "RKFV .." indicates 316 nickel plated brass housing.

FOUNDATION™ fieldbus

FOUNDATION™ fieldbus Physical Media Connectivity

(M12x1) Eurofast® Female Receptacles

- Mounted for quick connection to Enclosures
- Available for 1/2-14 NPT, 1/2-14 NPSM, 3/4-14 NPT and M20 Threads



Housing Style	Female Part Number	Male Part Number	Features	Pinout
<p>FKV..*M</p>	FKV 49-*M	FSV 49-*M	Nickel plated CuZn or stainless steel, 250 V, 4 A, -40 °C to +105 °C, 1/2-14 NPSM threads	<p>Female</p>
<p>FSV..*M</p>				<p>Male</p>

Standard cable length is 0.5 meters. Consult factory for other lengths.
 Receptacles require a 13/16" (21.0 mm) clearance hole for panel mounting.
 Standard housing material is stainless steel. "RKF .."; "RKFV .." indicates 316 nickel plated brass housing.

We reserve the right to make technical alterations without prior notice.

Male End View

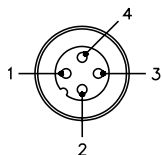

- 1 = BU (-voltage)
- 2 = BN (+ voltage)
- 3 = N/C
- 4 = GN/YE (ground)

49 Series

Male End View

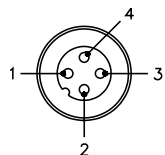

- 1 = BU (-voltage)
- 2 = BN (+ voltage)
- 3 = N/C
- 4 = N/C

49T Series

Male End View

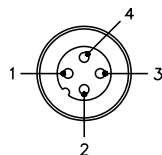

- 1 = BU (-voltage)
- 2 = BN (+ voltage)
- 3 = GY
- 4 = N/C

49D Series

Male End View

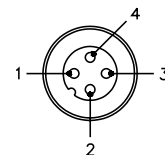

- 1 = BU (-voltage)
- 2 = BN (+ voltage)
- 3 = GY
- 4 = GN/YE (ground)

49E Series

Minifast® Field Wireable Connectors with Labels

- Allows for quick connection when Pre-Molded Cables are not available
- Available for Male and Female Connectors
- Color Coded Wire Connection for FOUNDATION fieldbus



Housing Style	Female Part Number	Male Part Number	Features	Pinout
	BKV 4140-0/11/FF	BSV 4140-0/11/FF	Glass filled nylon, stainless steel coupling nut, PG 9 cable gland, accepts 8-10 mm cable diameter, screw terminals, 90 °C, 300 V, 9 A, mates with standard, 4-pin cordsets and receptacles	<p>Female</p>
	BKV 4140-0/16/FF	BSV 4140-0/16/FF	Glass filled nylon, stainless steel coupling nut, PG 16 cable gland, accepts 12-14 mm cable diameter, screw terminals, 90 °C, 600 V, 9 A, mates with standard, 4-pin cordsets and receptacles	<p>Male</p>

We reserve the right to make technical alterations without prior notice.

FOUNDATION™ fieldbus

Gender Changer

- Allows Quick and Easy Changes from Male to Female and Minifast to Eurofast® Connectors



Housing Style	Part Number	Features	Wiring Diagrams
	RSM 49-FK 4.4	Nickel plated CuZn or stainless steel, 250 V, 4 A, -40 °C to +75 °C, female Eurofast, male Minifast, 4-pin	

Pinouts

Minifast	Eurofast
<p>Male</p>	<p>Female</p>

FOUNDATION™ fieldbus Physical Media Connectivity

FOUNDATION fieldbus, Conduit Adapters

- Converts Standard Conduits to Quick Disconnect
- Fiberglass Reinforced Nylon Housings
- Nickel Plated Brass Connectors available
- 3/4" Form 8 or Mark 9
- 1" Form 7 available upon request
- Gasket and Mounting Screws provided
- IP67



Housing Style	1 Port Part Number	2 Port Part Number	Specifications	Pinout
	BCA-49-E123	BCA-49-E223	3/4" Form 8 or Mark 9, M12 x 1 stainless steel connectors	Female
	BCA-49-M123	BCA-49-M223	3/4" Form 8 or Mark 9, 7/8"-16 UN stainless steel connectors	Female
	BCA-49SC-M123	BCA-49SC-M223	Short circuit protection, 3/4" Form 8 or Mark 9, 7/8"-16 UN stainless steel connectors	

FOUNDATION™ fieldbus, Conduit Adapters

- Attaches to Standard Single Gang Electrical Box
- Stainless Steel with Stainless Steel Connectors
- Gasket and Mounting Screws Provided
- IP67



Housing Style	Part Number	Specifications	Pinout
	BPA-49-M113	7/8"-16 UN, -40 °C to +75 °C (-40 °F to +167 °F)	Female

We reserve the right to make technical alterations without prior notice.

PROFIBUS-DP Cable	P3
Part Number Key	P4
Cordsets	P6
Receptacles	P13
Field Wireables	P17

Features

- Cables that meet the requirements of EN 50170 for communication up to 12 MBAUD
- PLTC rated cable (CSA FT4)
- Oil RES II and sunlight resistant
- M12 reverse keyed connectors
- Up to 4 Amp and 250 Volt rated
- IP67/IP69K rated



PROFIBUS-DP System Description

PROFIBUS-DP is an industrial network protocol that connects field I/O devices in order to eliminate hard wiring. The network connection increases device-level diagnostic capabilities, while also providing high-speed communication between devices.

PROFIBUS-DP is based on the RS-485 serial data transfer standard. In most cases, the termination and physical media rules for PROFIBUS-DP are the same as those required for RS-485 communication. A PROFIBUS-DP network supports up to 126 nodes and virtually an unlimited amount of I/O. The bus uses a trunkline/dropline topology. Power and communication are provided via separate cables, allowing easy segmentation of the power structure to avoid overloading.

PROFIBUS-DP is capable of running at data rates as high as 12 Mbaud. When used at high data rates, the cable drop length from the trunk to a node is severely limited. For example, when used at 12 Mbaud, nodes must be directly connected to the trunk, with no drop length allowed.

Typical System Configuration

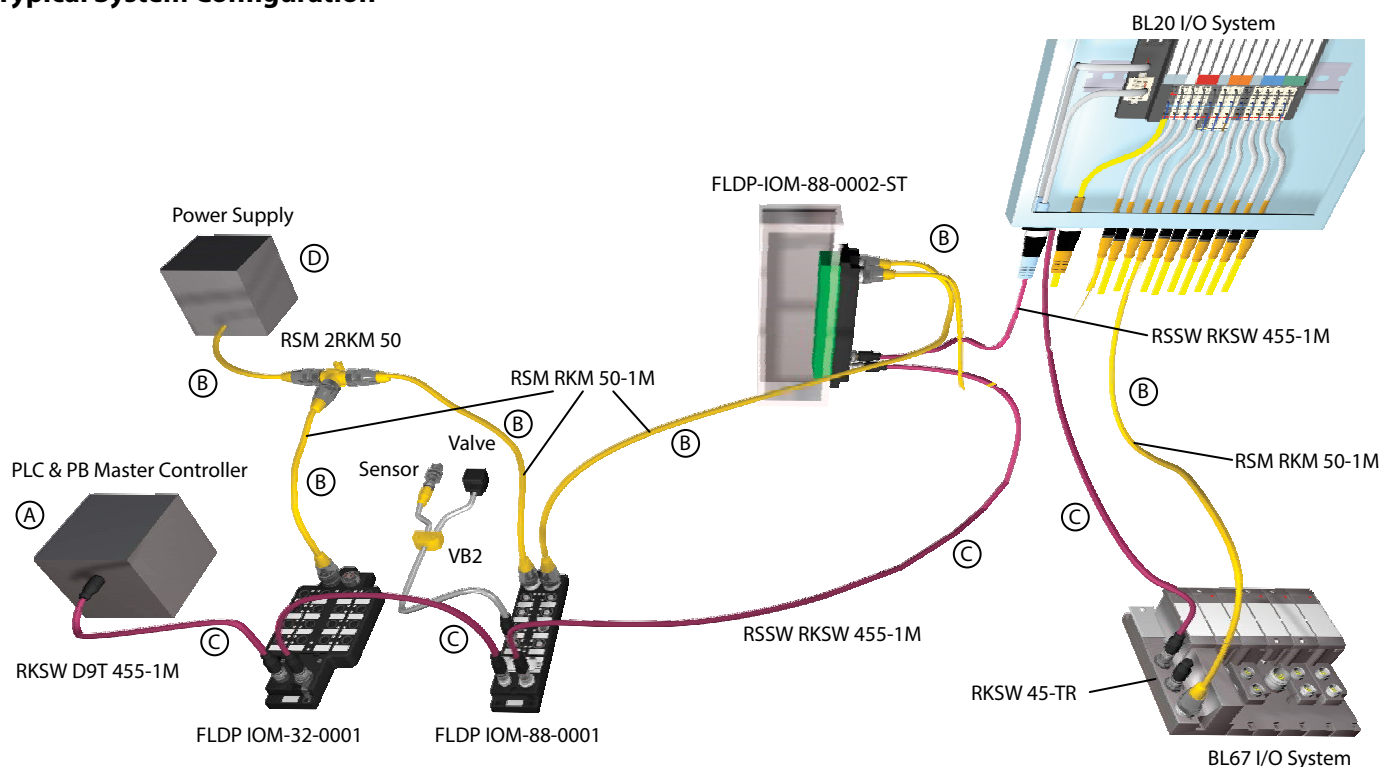

Basic Parts List

A typical PROFIBUS-DP system consists of the following parts:

- A - Master
- B - Power cable
- C - Communication cable
- D - Power supply

PROFIBUS-DP stations require a network master (also called a scanner) to interface the stations to the host controller. Turck PROFIBUS-DP stations are designed to be fully compatible with PROFIBUS-DP equipment from other manufacturers.

Cordsets

Turck offers a complete line of molded PROFIBUS-DP cordsets to facilitate network installation, resulting in a faster start-up and fewer wiring errors. The bus and drop cables are specially designed foil-shielded, high-flex cables with very low inductance and capacitance to minimize propagation delay time. PROFIBUS-DP cables consist of a shielded and twisted data pair with a bare drain wire.

In most cases, connections of the bus cable to the stations are made using 5-pin reverse-key Eurofast® (M12) connectors. A variety of stations are also available that support D9 type connections. Power for most stations is provided through one or two 5-pin Minifast® (7/8-16 UN) connectors.

Turck cordsets for the PROFIBUS-DP system are available in standard lengths. Please contact your local sales representative to order custom lengths.

Communication Rate/Cycle Time

PROFIBUS-DP specifications define multiple transmission speeds ranging from 9.6 Kbaud to 12 Mbaud. All nodes on a network must communicate at the same rate.

The complete cycle time of a PROFIBUS-DP system is affected by several factors:

- Number of nodes being scanned
- Amount of data produced and consumed by the nodes
- Network communication rate
- Cycle time of the control program

All of these factors must be considered when calculating the cycle time of a particular network.

Maximum Ratings

The PROFIBUS-DP bus uses a trunkline/dropline topology. The trunk is the main communication cable and requires the appropriate RS-485 termination at both ends of the trunk. Terminating resistors are available as plug-in Eurofast modules or can be built into the D9 connectors. The length of the trunk depends on the communication rate. Drops or branches off the trunk are allowed, but are greatly limited as the communication rate increases. The table shows the maximum ratings for a trunk at different communication rates.

Communication Rate	Max. Segment Length
9.6 kbps	1200 m
19.2 kbps	1200 m
93.75 kbps	1200 m
187.5 kbps	1000 m
500 kbps	400 m
1.5 Mbps	200 m
12 Mbps	100 m

PROFIBUS® –DP Physical Media Connectivity

Eurofast® Cordset Part Number Key

Part Number Keys are to assist in IDENTIFICATION ONLY. Consult factory for catalog items not identified.

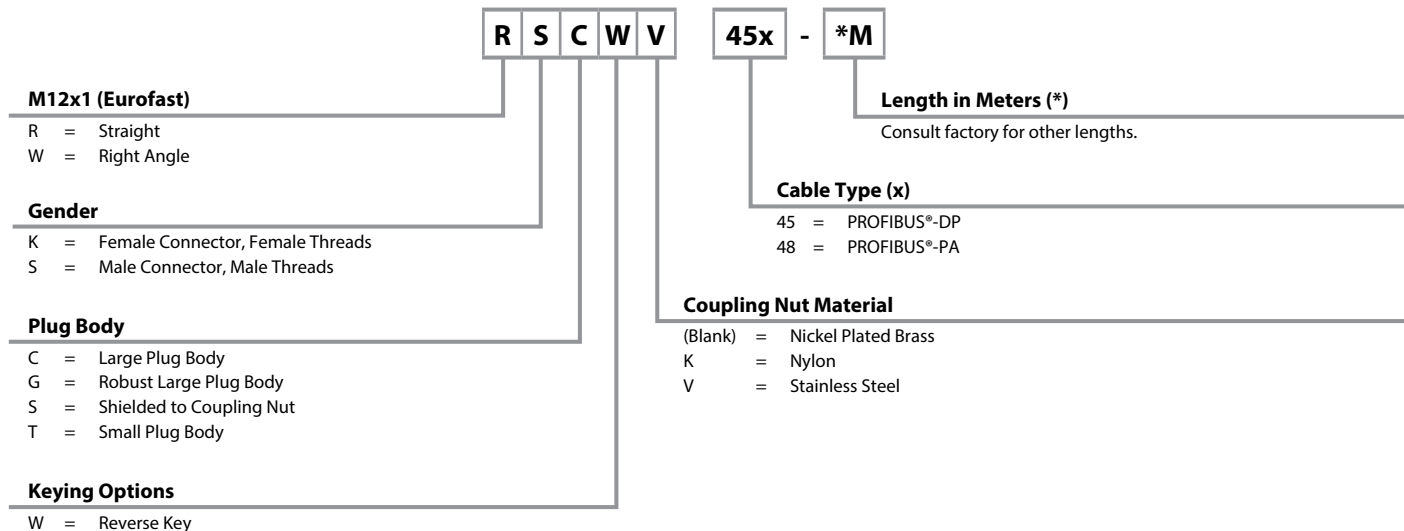

Eurofast Receptacle Part Number Key

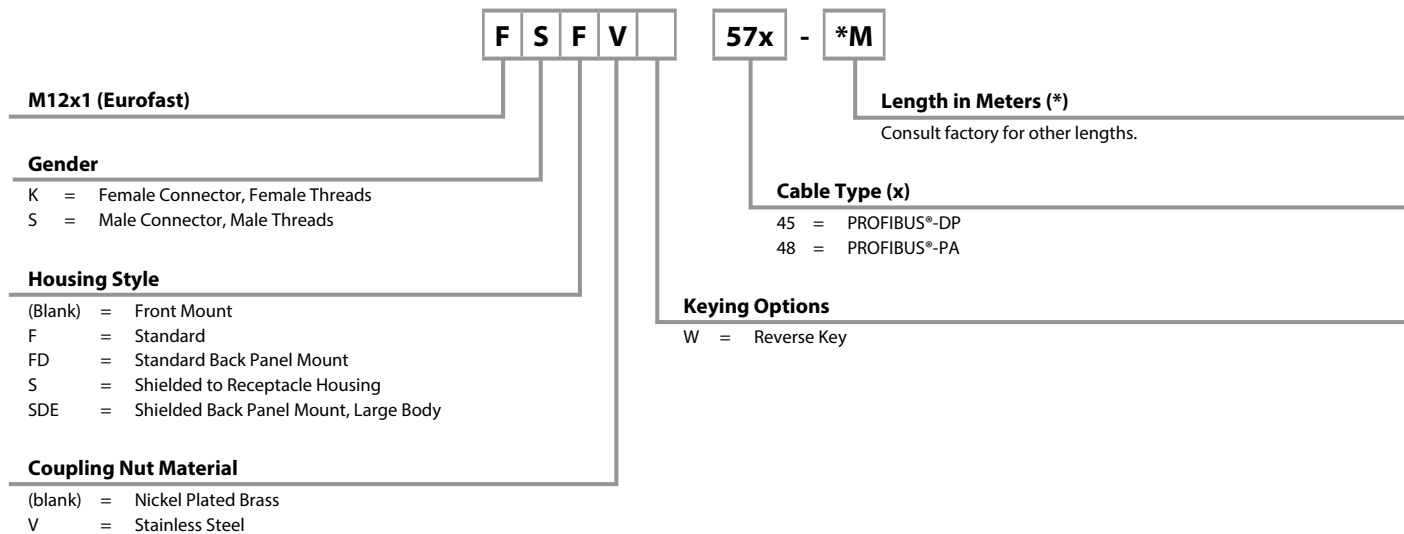

PROFIBUS-DP, Cable Specifications

- Cable that meets the requirements of EN50170-2-2:1996 for communications up to 12 Mbaud

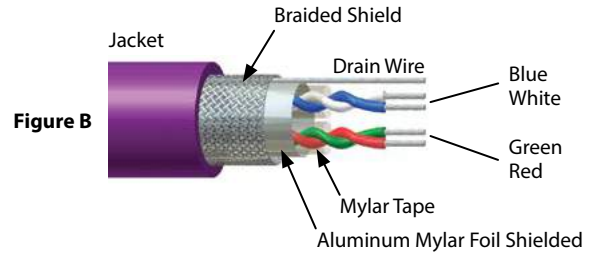
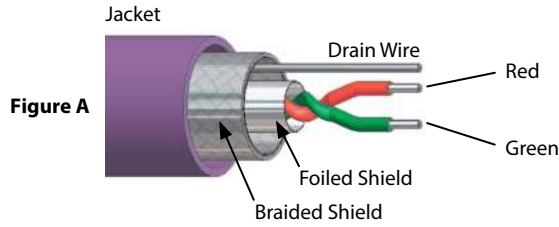

Baud Rate (k baud)	9.6	19.2	93.75	187.5	500	1500	1200
Maximum Trunk Length	1200 meters	1200 meters	1200 meters	1000 meters	400 meters	200 meters	100 meters

Type	Approvals	Data Pair		2nd Data Pair		Outer Jacket Material Color Nominal O.D.	Shields Type Drain Wire	Bulk Cable Part Number / Weight/300 M
		AWG Color Code	Characteristic Impedance @ 1 MHz/Insulation	AWG Color Code	Characteristic Impedance @ 1 MHz/Insulation			
455 80 °C 300 V	UL PLTC-ER DB CSA CMX-OUTDOOR-CMG AWM I/II A/B, FT 4	2X22 AWG RD/GN	150 Ohms HDPE	None	n/a	PVC, VIOLET, 8.5 mm (.335 in)	Foil/braid, 22 AWG	RB50672-*M, 63 lbs.
456 80 °C 300 V	UL recognized AWM CSA AWM I/II A/B, FT 1	2X22 AWG RD/GN	150 Ohms HDPE	None	n/a	TPU, VIOLET, 7.9 mm (.310 in)	Foil/braid, 22 AWG	RB50683-*M, 45 lbs.
457 80 °C 600 V	UL recognized AWM VW-1	2X22 AWG RD/GN Solid	150 Ohms HDPE	None	n/a	TPU, VIOLET, 7.8 mm (.305 in)	Foil/braid	RB50708-*M, 39 lbs.
458 80 °C 300 V	UL recognized AWM CSA AWM I/II A/B, FT 1	2X22 AWG RD/GN	150 Ohms HDPE	None	n/a	TPU, PLUM, 8.5 mm (.335 in)	Foil/braid, 22 AWG	RB50692-*M, 52 lbs. Flexlife®
4511 80 °C 300 V	UL PLTC CSA CMX-OUTDOOR-CMG AWM I/II A/B, FT 4	2X22 AWG RD/GN	150 Ohms HDPE	None	n/a	PVC, VIOLET, 8.5 mm (.335 in)	Foil/braid, 22 AWG	RB50881-*M, 58 lbs. Flexlife
4515 80 °C 600 V	IEC-60332-3 IEC-60754-1 EN 50267-2-2	2X22 AWG RD/GN	150 Ohms HDPE	None	n/a	TPU, VIOLET, 7.9 mm (.310 in) Halogen-free	Foil/braid, 22 AWG	RB51225-*M, 41 lbs.
590 80 °C 300 V	UL recognized AWM CSA AWM I/II A/B, FT 1	2X22 AWG RD/GN	150 Ohms HDPE	2X22 AWG BU/WT	150 Ohms HDPE	PVC, VIOLET, 8.4 mm (.330 in)	Foil/braid, 22 AWG	RB51057-*M, 52 lbs.





* Indicates length in meters.
Standard spool lengths are 30, 75, 100, 150, 200, 225, 300 meters. Consult factory for other lengths.

We reserve the right to make technical alterations without prior notice.

PROFIBUS®-DP Connectivity

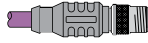
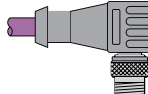
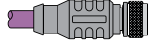
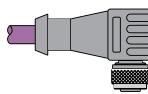
PROFIBUS® –DP Physical Media Connectivity

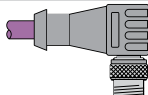
PROFIBUS-DP, (M12x1) Eurofast® Cable and Cordset Selection Matrix

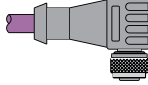
		Eurofast (Male)		Eurofast (Female)	
		 1 RSSW	 2 WSSW	 3 RKSX	 4 WKSX
 Bare		RSSW 45x-*M	WSSW 45x-*M	RKSX 45x-*M	WKSX 45x-*M
Eurofast (Male)	 1 RSSW	RSSW RSSW 45x-*M	RSSW WSSW 45x-*M	RSSW RKSX 45x-*M	RSSW WKSX 45x-*M
	 2 WSSW		WSSW WSSW 45x-*M	WSSW RKSX 45x-*M	WSSW WKSX 45x-*M
Eurofast (Female)	 3 RKSX			RKSX RKSX 45x-*M	RKSX WKSX 45x-*M
	 4 WKSX				WKSX WKSX 45x-*M

See page P8 for dimensional drawings.

* Indicates length in meters.

x Indicates cable type.

Standard cable lengths are 1, 2, 4, 6, 8, 10, 15, and in +5 meter increments from there. Consult factory for other lengths.

For stainless steel coupling nuts change part number RSSW...RSSWV.

We reserve the right to make technical alterations without prior notice.

Pinouts

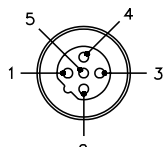
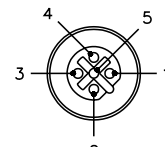
Eurofast	45 series pinout	59 series pinout	Eurofast
Male			Female
	1. N/C 2. Green (TxD) 3. N/C 4. Red (RxD) 5. Bare (Shield Drain Wire)	1. Blue (TxD_1) 2. Green (TxD) 3. White (RxD_1) 4. Red (RxD) 5. Bare (Shield Drain Wire)	

Specifications

Overmold:	TPU	Protection:	NEMA 1, 3, 4, 6P and IEC IP 68
Coupling Nut:	Nickel Plated CuZn or Stainless Steel	Rated Voltage:	250 V
Contact Carrier:	TPU or POM (Nylon)	Rated Current:	4 A
Contacts:	Gold Plated CuZn	Ambient Temperature:	-40 °C to +75 °C (-22 °F to +167 °F)

We reserve the right to make technical alterations without prior notice.

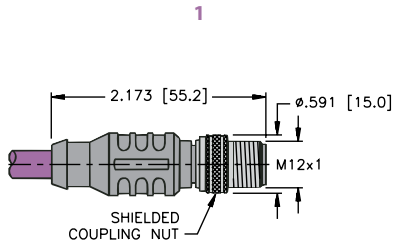

RSSW ..

Page P6

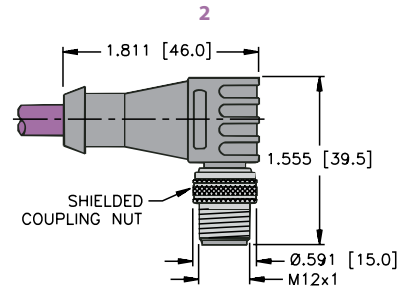

WSSW ..

Page P6

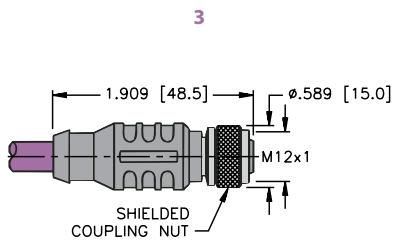

RKSU ..

Page P6

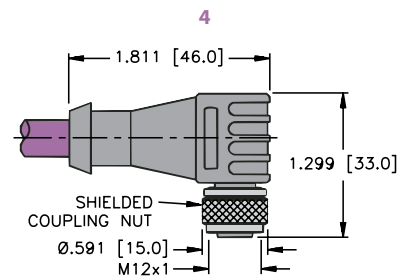

WKSU ..

Page P6

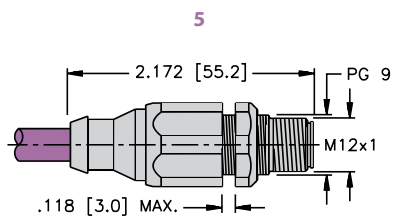

FSSDWE ..

Page P8

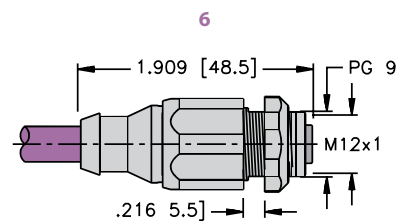





FKSDWE ..

Page P8

PROFIBUS®-DP Connectivity

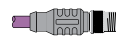
PROFIBUS® –DP Physical Media Connectivity

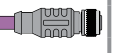
PROFIBUS-DP, (M12x1) Eurofast® Cable and Cordset Selection Matrix

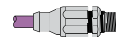
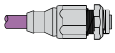
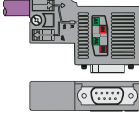
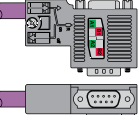
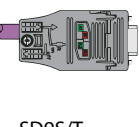
		Eurofast						
		Male			Female		Male	Female
		1	2	3	4	5	6	
								
		Bare	RSSW	WSSW	RKSX	WKSX	FSSDWE	FKSDWE
9-Pin Sub D Connector	Terminator	 D9S/T	RSSW D9S/T 45x-*M	WSSW D9S/T 45x-*M	RKSX D9S/T 45x-*M	WKSX D9S/T 45x-*M	FSSDWE D9S/T 45x-*M	FKSDWE D9S/T 45x-*M
	Master	 D9SM/T	RSSW D9SM/T 45x-*M	WSSW D9SM/T 45x-*M	RKSX D9SM/T 45x-*M	WKSX D9SM/T 45x-*M	FSSDWE D9SM/T 45x-*M	FKSDWE D9SM/T 45x-*M
		 SD9S/T	RSSW SD9S/T 45x-*M	WSSW SD9S/T 45x-*M	RKSX SD9S/T 45x-*M	WKSX SD9S/T 45x-*M	FSSDWE SD9S/T 45x-*M	FKSDWE SD9S/T 45x-*M

See page P8 and P11 for dimensional drawings.

* Indicates length in meters.

x Indicates cable type.

Standard cable lengths are 1, 2, 4, 6, 8, 10, 15, and in +5 meter increments from there. Consult factory for other lengths.

For stainless steel coupling nuts change part number RSSW...RSSWV.

Extension Example:

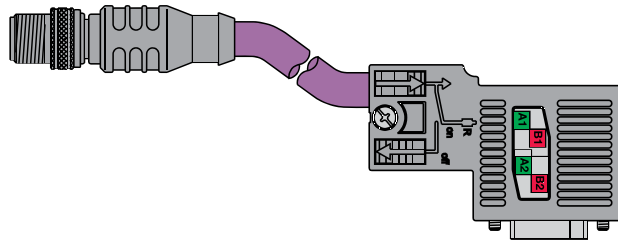



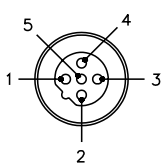
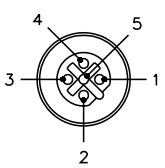
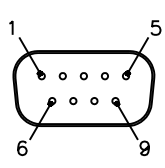

RSSW D9S/T 455-0.3M

Pinouts





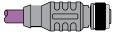

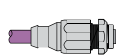
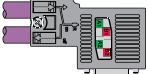
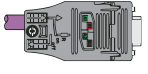
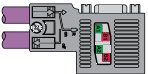
Eurofast	45 series pinout	Eurofast	D9	D9 pinout
Male		Female	Male	
	1. N/C 2. Green (TxD) 3. N/C 4. Red (RxD) 5. Bare (Shield Drain Wire)			1 = N/C 2 = N/C 3 = RD (RXD) 4 = N/C 5 = N/C 6 = N/C 7 = N/C 8 = GN (TXD) 9 = N/C

We reserve the right to make technical alterations without prior notice.

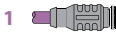
PROFIBUS-DP, (M12x1) Eurofast® Cable and Cordset Selection Matrix

		Eurofast						
		Male		Female		Male	Female	
								
		Bare	RSSW	WSSW	RKSW	WKSW	FSSDWE	FKSDWE
Node		D9S 45x-*M	RSSW D9S RSSW 45x-*M-*M	WSSW D9S WSSW 45x-*M-*M	RKSW D9S RKSW 45x-*M-*M	WKSW D9S WKSW 45x-*M-*M	FSSDWE D9S FSSDWE 45x-*M-*M	FKSDWE D9S FKSDWE 45x-*M-*M
	D9S							
Straight		SD9S 45x-*M	RSSW SD9S RSSW 45x-*M-*M	WSSW SD9S WSSW 45x-*M-*M	RKSW SD9S RKSW 45x-*M-*M	WKSW SD9S WKSW 45x-*M-*M	FSSDWE SD9S FSSDWE 45x-*M-*M	FKSDWE SD9S FKSDWE 45x-*M-*M
	SD9S							
Node		D9SM 45x-*M	RSSW D9SM RSSW 45x-*M	WSSW D9SM WSSW 45x-*M-*M	RKSW D9SM RKSW 45x-*M-*M	WKSW D9SM WKSW 45x-*M-*M	FSSDWE D9SM FSSDWE 45x-*M-*M	FKSDWE D9S FKSDWE 45x-*M-*M
	D9SM							

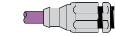
We reserve the right to make technical alterations without prior notice.

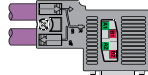
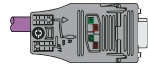
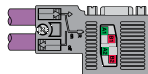
		Eurofast						
		Male	Female	Male	Female	Male	Female	
								
		Bare	RSSW	RKSW	WSSW	WKSW	FSSDWE	FKSDWE
Node		D9S 45x-*M	RSSW D9S RKSW 45x-*M-*M		WSSW D9S WKSW 45x-*M-*M		FSSDWE D9S FKSDWE 45x-*M-*M	
	D9S							
Straight		SD9S 45x-*M	RSSW SD9S RKSW 45x-*M-*M		WSSW SD9S WKSW 45x-*M-*M		FSSDWE SD9S FKSDWE 45x-*M-*M	
	SD9S							
Node		D9SM 45x-*M	RSSW D9SM RKSW 45x-*M-*M		WSSW D9SM WKSW 45x-*M-*M		FSSDWE D9SM FKSDWE 45x-*M-*M	
	D9SM							

See page P8 and P11-P12 for dimensional drawings.

* Indicates length in meters.

x Indicates cable type.

Standard cable lengths are 1, 2, 4, 6, 8, 10, 15, and in +5 meter increments from there. Consult factory for other lengths.

For stainless steel coupling nuts change part number RSSW...RSSWV.

PROFIBUS®-DP Connectivity

PROFIBUS® –DP Physical Media Connectivity

PROFIBUS-DP, Field Wireable D9 Connectors

- Provides connection to Master or Node in the field
- Maximum Cable O.D. is 8.5 mm

Housing Style	Part Number	Features	Pinout
	Connector,PDP,D9S	-25 °C to +80 °C, right angle, terminating switch	
	Connector,PDP,SD9S	-25 °C to +80 °C, straight, terminating switch	1. N/C 2. N/C 3. RED (Bus_B) 4. N/C 5. N/C 6. N/C 7. N/C 8. Green (Bus_A) 9. N/C
	Connector,PDP,D9SM	-25 °C to +80 °C, right angle, master, terminating switch	

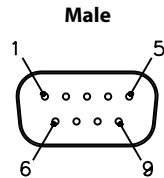

We reserve the right to make technical alterations without prior notice.

Specifications - (D9)

Terminating Switch: Yes
Protection: IEC IP 20
Rated Voltage: 4.75-5.25 VDC

Rated Current: 5 mA
Temperature Rating: -25 °C to +60 °C
 *Max. Cable diameter: 8.5 mm

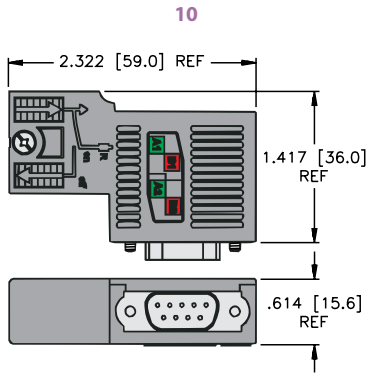

Connector, PDP, D9S

Page P8

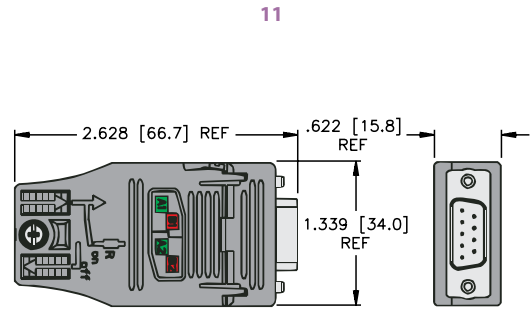

Connector, PDP, SD9S

Page P8

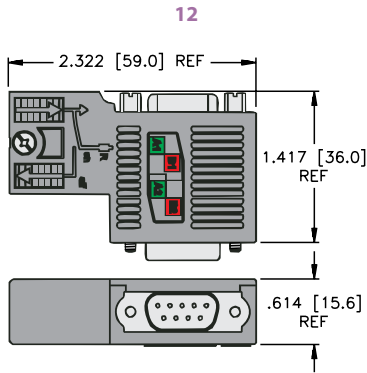

Connector, PDP, D9SM

Page P8

We reserve the right to make technical alterations without prior notice.

PROFIBUS®-DP Connectivity

PROFIBUS® –DP Physical Media Connectivity

PROFIBUS-DP, Terminating Resistors

- Terminating Resistors stabilize and minimize reflections on the Bus Line
- A Terminating Resistor is required at the beginning and end of the Main Bus Line



Housing Style	Part Number	Features	Pinout	
	RSSW 45-TR	Nickel plated brass, 250 V, 4 A, -40 °C to +75 °C, internal resistor, male Eurofast connector, reverse keyed	<ol style="list-style-type: none"> 1. N/C 2. GN 3. N/C 4. RD 5. BARE 	See Below
	RKSW 45-TR	Nickel plated brass, 250 V, 4 A, -40 °C to +75 °C, internal resistor, female Eurofast connector, reverse keyed	<ol style="list-style-type: none"> 1. N/C 2. GN 3. N/C 4. RD 5. BARE 	See Below
	PDP-TRA	Nickel plated brass, 250 V, 4 A, -40 °C to +75 °C, active terminating resistor, external power supply Minifast® and Eurofast connector, LED signal for power status	<ol style="list-style-type: none"> 1. N/C 2. BUS_A 3. N/C 4. BUS_B 5. N/C 	See Below
			<ol style="list-style-type: none"> 1. N/C 2. GND 3. N/C 4. UI=24 VDC 5. N/C 	

We reserve the right to make technical alterations without prior notice.

Pinout Diagram, RSSW 45-TR

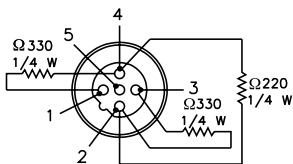

Eurofast Male Connector

Pinout Diagram, RKSW 45-TR

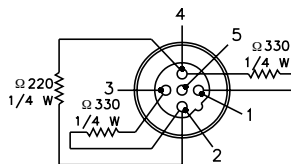

Eurofast Female Connector

Pinout Diagram, PDP-TRA

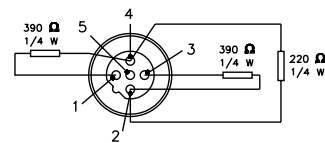

Eurofast Male Connector

PROFIBUS-DP, Circuit Board Connectors and OEM Receptacles

- Provides (M12x1) Eurofast® Connection to Field Devices



Housing Style	Female Part Number	Male Part Number	Features	Pinout
<p>FKFDW 45..</p>	FKFDW 45-PCB	FSFDW 45-PCB	Nickel plated CuZn or stainless Steel, 250 V, 4 A, -40 °C to +75 °C, male Eurofast PCB pins	<p>Female</p>
<p>FSFDW 45..</p>				
<p>FKFDLW 45..</p>	FKFDLW 45	FSFDLW 45	Nickel plated CuZn or stainless Steel, 250 V, 4 A, -40 °C to +75 °C, male Eurofast solder cups	<ol style="list-style-type: none"> 1. N/C 2. GN 3. N/C 4. RD 5. BARE
<p>FSFDLW 45..</p>				
<p>WFSW 45..</p>		WFSW 45-PCB	Nickel plated CuZn or stainless Steel, 250 V, 4 A, -40 °C to +75 °C, male Eurofast right angle PCB pins	<p>Male</p>

We reserve the right to make technical alterations without prior notice.

PROFIBUS®-DP Connectivity

Standard housing material is nickel plated brass "FKFD .."; "FKFDV .." indicates 316 stainless steel.

Panel Cutout
FKFD ... FSFD

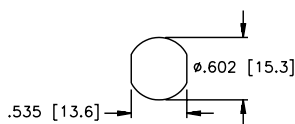

Board Layout (reference only)
FKFD ... FSFD

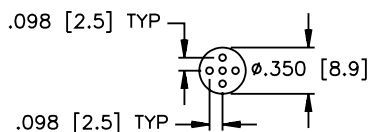

Panel Cutout
WFS

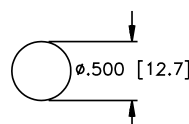

Board Layout (reference only)
WFS

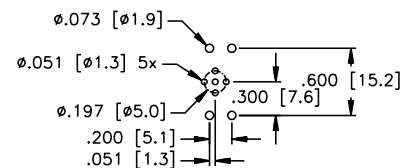

PROFIBUS® –DP Physical Media Connectivity

PROFIBUS-DP, Circuit Board Connectors and OEM Receptacles

- Provides (M12x1) Eurofast® Connection to Field Devices



Housing Style	Female Part Number	Male Part Number	Features	Pinout
<p>FKW 45 PCB KIT</p>	FKW 45-PCB KIT	FSW 45-PCB KIT	Nickel plated CuZn or stainless steel, 250 V, 4 A, -30 °C to +75 °C, male Eurofast with mounting kit, reverse key	<p>Female</p>
<p>FSW 45 PCB KIT</p>				
<p>FK 45 PCB</p>	FK 45-PCB	FSW 45-PCB	Nickel plated CuZn or stainless steel, 250 V, 4 A, -30 °C to +75 °C, male Eurofast, reverse key	<p>Male</p>
<p>FSW 45 PCB</p>				

We reserve the right to make technical alterations without prior notice.

Standard housing material is nickel plated brass "FKFD .."; "FKFDV .." indicates 316 stainless steel.

Board Layout (reference only) FK ... FS

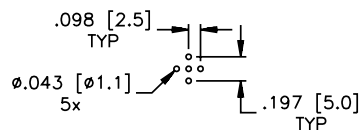

PROFIBUS-DP, Eurofast® Feed Through Receptacle

- Provides Bulkhead Panel Mount Connection



Housing Style	Part Number	Features	Pinout
	<p>FKW FSW 45/M12</p>	<p>Nickel plated brass or stainless steel, 250 V, 4 A, -40 °C to +75 °C, straight male/female connector, for pre-molded reverse keyed Eurofast cables</p>	<p>Female</p> <p>Male</p>

For stainless steel change part number to FKVV FSWV 45/M12

We reserve the right to make technical alterations without prior notice.

PROFIBUS®-DP Connectivity

PROFIBUS® –DP Physical Media Connectivity

PROFIBUS-DP, Eurofast® Bus Tees

- Creates a Branch from the Main Bus Line



Housing Style	Part Number	Features	Wiring Diagrams
	RКСW 2RSSW 45/CM	TPU, Nickel plated brass, 250 V, 4 A, -40 °C to +75 °C, male Eurofast drop connector, fully shielded Eurofast tee, passive termination	
	VB2-FSW/FKW/FSW 45	TPU, Nickel plated brass, 250 V, 4 A, -40 °C to +75 °C, Y Junction, fully shielded Eurofast connectors	

We reserve the right to make technical alterations without prior notice.

Pinouts

Eurofast	
Male	Female

PROFIBUS-DP, Eurofast® Field Wireable Connectors with Labels

- Allows for Quick Connection when Pre-Molded Cables not available
- Available for Male and Female connectors
- Color Coded Wire Connection for PROFIBUS-DP



Housing Style	Female Part Number	Male Part Number	Features	Pinout
<p>FKFD 57 PCB</p> <p>FKFD 57 PCB</p>	<p>BMWS 8151-8.5/PDP</p>	<p>BMSWS 8151-8.5/PDP</p>	<p>Nickel plated brass, PG 9 cable gland, accepts 4-9 mm cable diameter, screw terminals, accepts up to 18 AWG conductors 85 °C, 125 V, 4 A, mates with reverse key, 5-pin cordsets and receptacles, metal, fully shielded</p>	<p>Female</p>
<p>FKFD 57 PCB</p> <p>FKFD 57 PCB</p>				<p>BMWS 8251-8.5/PDP</p>

We reserve the right to make technical alterations without prior notice.

PROFIBUS®-DP Connectivity

Cordsets	P22
Receptacles	P24
Terminating resistors	P30
Tees	P31
Field Wireables	P33

Features

- Cable that meets the requirements of ISA/SP 50 and PROFIBUS-PA requirements for Type A Cable
- All cables are rated -40 °C to +105 °C and are sunlight resistant
- Available in 3-wire versions with a device ground or 2-wire versions
- PLTC and ITC listed (CSA FTA)
- Exposed Run (ER) and Direct Burial listed
- IP67 Rated



PROFIBUS®-PA Connectivity

PROFIBUS-PA Overview

PROFIBUS-PA (Process Automation) uses synchronous transfer mode technology, as defined in IEC 61158-2, to communicate between field devices and the RS 485 backbone of PROFIBUS®-DP. A segment coupler, or gateway is installed to bridge PROFIBUS-DP with PROFIBUS-PA. Otherwise, the protocols are identical, allowing transparent communication between general purpose automation systems and decentralized field devices.

PROFIBUS-PA is a master-slave bus. Transmitters used in the process industry are typically slave devices or passive stations which only communicate at the request of the master.

General Layout Topologies

The topology for PROFIBUS-DP is a linear bus. Branching can be accomplished with repeaters or, in the case of PROFIBUS-PA, this can be accomplished with the segment couplers. The PROFIBUS-PA topology follows the physical layer as defined in ISA SP50.02. Daisy chain or star topologies are allowed.

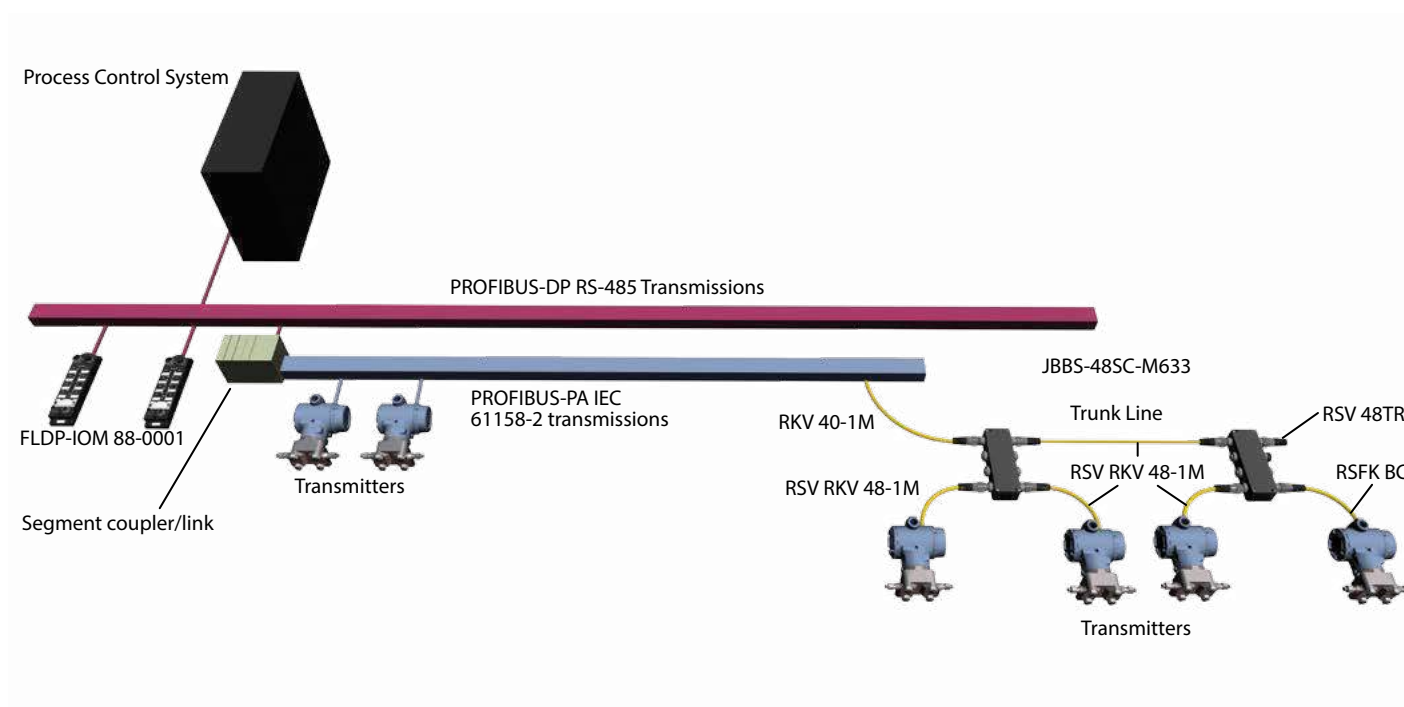

PROFIBUS-PA, Cable Specifications

- Cable that meets the requirements of ISA/SP50 and PROFIBUS-PA requirements for Type A Cable
- All Cables are rated -40 °C to +105 °C and are Sunlight Resistant
- Available in 3-wire versions with a Device Ground or 2-wire versions

Type A Cable Specifications

- Temperature range: -40 °C to +105 °C
- UV Resistant
- PLTC and ITC Listed (CSA FT4)
- Exposed Run (ER) and Direct Buried (DB) Listed
- Maximum Attenuation at 1.25 f_r (39 kHz) = 3.0 dB/km
- Characteristic Impedance 100 Ω ± 10 Ω @ 31.25 KHz
- Capacitance: 20 pF/Ft nominal
- Inductance: 0.22 μH/Ft. nominal
- Conductor Cross-sectional area (wire size) = nominal 0.75 mm² (#18 AWG) or 1.5 mm² (#16 AWG)
- Shield Coverage =100 %

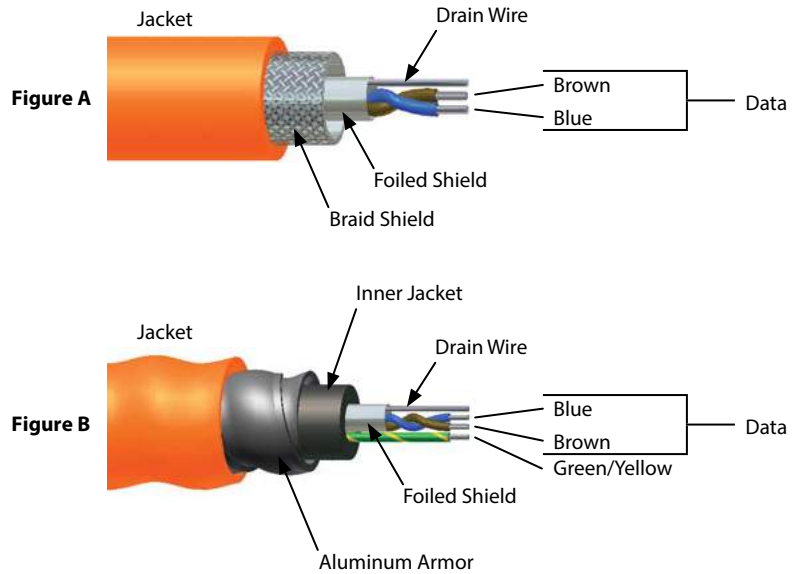

We reserve the right to make technical alterations without prior notice.







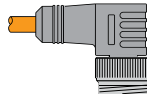

PROFIBUS®-PA Connectivity

Type	Approvals	Data Pair		Device Ground	Outer Jacket	Shields	Bulk Cable Part Number / Weight/300 M
		AWG Color Code	DCR (/1000 feet) Insulation	AWG Color Code	Material Color Nominal O.D.	Type Drain Wire	
483 105 °C, 600 V	c(UL) 1309 MS, ITC-ER DB, CIC/TC, FT1 FT4	2X18 AWG BU/BN	7.06 Ohms XLPE	None	PVC, ORANGE, 8.5 mm (.335 in)	Foil/braid, 20 AWG	RB50785-*M, 66 lbs.
483B 105 °C, 600 V	c(UL) 1309 MS, ITC-ER DB, CIC/TC, FT1 FT4	2X18 AWG BU/BN	7.06 Ohms XLPE	None	PVC, BLUE, 8.5 mm (.335 in)	Foil/braid, 20 AWG	RB50786-*M, 66 lbs.
482A 105 °C, 300 V	UL ITC-ER DB CSA ACIC HL-ABCD, FT1 FT4	2X18 AWG BU/BN	7.06 Ohms XLPE	18 AWG, GN-YE	PVC, ORANGE, 15.6 mm (.615 in)	Foil/armor, 20 AWG	RB50929-*M, 184 lbs.
482BA 105 °C, 300 V	UL ITC-ER DB CSA ACIC HL-ABCD, FT1 FT4	2X18 AWG BU/BN	7.06 Ohms XLPE	18 AWG, GN-YE	PVC, BLUE, 15.6 mm (.615 in)	Foil/armor, 20 AWG	RB50803-*M, 184 lbs. Flexlife
483BK 105 °C, 600 V	c(UL) 1309 MS, ITC-ER DB, CIC/TC, FT1 FT4	2X18 AWG BU/BN	7.06 Ohms XLPE	None	PVC, BLACK 8.5 mm (.335 in)	Foil/braid, 20 AWG	RB50860-*M, 66 lbs.

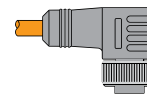
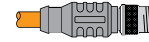
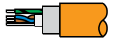
* Indicates length in meters. Standard spool lengths are 30, 75, 100, 150, 200, 225, 300 meters. Consult factory for other lengths.

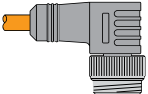
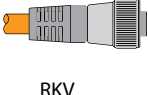
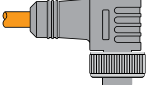
PROFIBUS® –PA Physical Media Connectivity

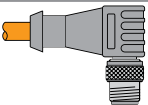
PROFIBUS-PA, Cable and Cordset Selection Matrix

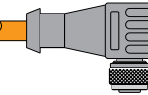
		Minifast®				Eurofast®
		(Male)		(Female)		Male
		 1 RSV	 3 WSV	 2 RKV	 4 WKV	 7 RSCV
	 Bare	RSV 48x-*M	WSV 48x-*M	RKV 48x-*M	WKV 48x-*M	RSCV 48x-*M
Minifast (Male)	 1 RSV	RSV RSV 48x-*M	RSV WSV 48x-*M	RSV RKV 48x-*M	RSV WKV 48x-*M	RSV RSCV 48x-*M
	 3 WSV		WSV WSV 48x-*M	WSV RKV 48x-*M	WSV WKV 48x-*M	WSV RSCV 48x-*M
Minifast (Female)	 2 RKV			RKV RKV 48x-*M	RKV WKV 48x-*M	RKV RSCV 48x-*M
	 4 WKV				WKV WKV 48x-*M	WKV RSCV 48x-*M
Eurofast (Male)	 7 RSCV					RSCV RSCV 48x-*M
	 9 WSCV					
Eurofast (Female)	 8 RKCVC					
	 10 WKCVC					

We reserve the right to make technical alterations without prior notice.

See pages P26 - P27 for dimensional drawings.

* Indicates length in meters.

x Indicates cable type.

Standard cable lengths are 1, 2, 4, 6, 8, 10, 15, and in +5 meter increments from there. Consult factory for other lengths.

PROFIBUS-PA, Cable and Cordset Selection Matrix

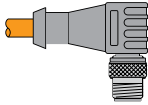
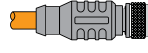
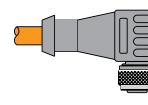
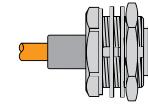
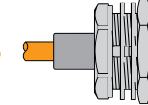
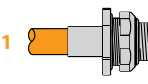
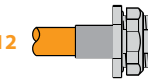
Eurofast®			Minifast® Bulkhead		Eurofast Bulkhead	
Male	Female		Male	Female	Male	Female
						
WSCV	RKCV	WKCV	RSFPV	RKFPV	FSFDV	FKFDV
WSCV 48x-*M	RKCV 48x-*M	WKCV 48x-*M	RSFPV 48x-*M	RKFPV 48x-*M	FSFDV 48x-*M	FKFDV 48x-*M
RSV WSCV 48x-*M	RSV RKCV 48x-*M	RSV WKCV 48x-*M	RSV RSFPV 48x-*M	RSV RKFPV 48x-*M	RSV FSFDV 48x-*M	RSV FKFDV 48x-*M
WSV WSCV 48x-*M	WSV RKCV 48x-*M	WSV WKCV 48x-*M	WSV RSFPV 48x-*M	WSV RKFPV 48x-*M	WSV FSFDV 48x-*M	WSV FKFDV 48x-*M
RKV WSCV 48x-*M	RKV RKCV 48x-*M	RKV WKCV 48x-*M	RKV RSFPV 48x-*M	RKV RKFPV 48x-*M	RKV FSFDV 48x-*M	RKV FKFDV 48x-*M
WKV WSCV 48x-*M	WKV RKCV 48x-*M	WKV WKCV 48x-*M	WKV RSFPV 48x-*M	WKV RKFPV 48x-*M	WKV FSFDV 48x-*M	WKV FKFDV 48x-*M
RSCV WSCV 48x-*M	RSCV RKCV 48x-*M	RSCV WKCV 48x-*M	RSCV RSFPV 48x-*M	RSCV RKFPV 48x-*M	RSCV FSFDV 48x-*M	RSCV FKFDV 48x-*M
WSCV WSCV 48x-*M	WSCV RKCV 48x-*M	WSCV WKCV 48x-*M	WSCV RSFPV 48x-*M	WSCV RKFPV 48x-*M	WSCV FSFDV 48x-*M	WSCV FKFDV 48x-*M
	RKCV RKCV 48x-*M	RKCV WKCV 48x-*M	RKCV RSFPV 48x-*M	RKCV RKFPV 48x-*M	RKCV FSFDV 48x-*M	RKCV FKFDV 48x-*M
		WKCV WKCV 48x-*M	WKCV RSFPV 48x-*M	WKCV RKFPV 48x-*M	WKCV FSFDV 48x-*M	WKCV FKFDV 48x-*M

We reserve the right to make technical alterations without prior notice.

PROFIBUS®-PA Connectivity

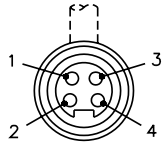
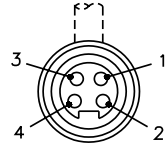
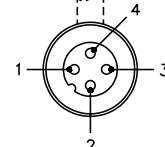
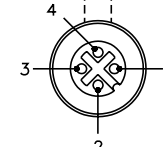
Minifast		Pinouts	Eurofast	
Male	Female		Male	Female
		1. Brown (+ Voltage) 2. N/C 3. Blue (- Voltage) 4. Bare (Shield Drain Wire)		

Specifications

Overmold:	TPU	Protection:	NEMA 1, 3, 4, 6P and IEC IP 68
Coupling Nut:	Nickel Plated CuZn or Stainless Steel	Rated Voltage:	300 V
Contact Carrier:	TPU	Rated Current:	9 A
Contacts:	Gold Plated CuZn	Ambient Temperature:	-40 °C to +105 °C (-40 °F to +221 °F)

1

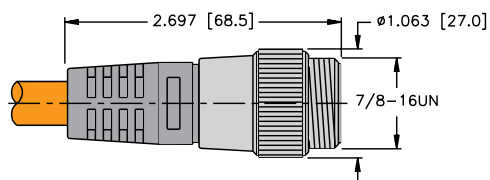

RSV ..

Page P22

2

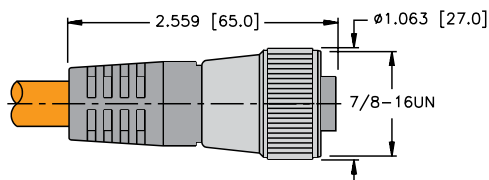

RKV ..

Page P22

3

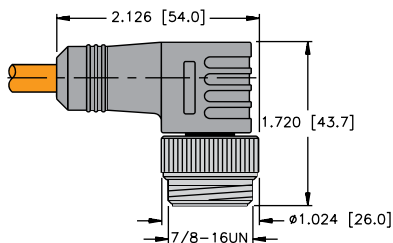

WSV ..

Page P22

4

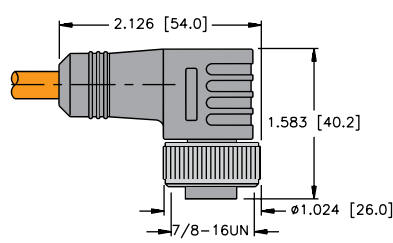

WKV ..

Page P22

5

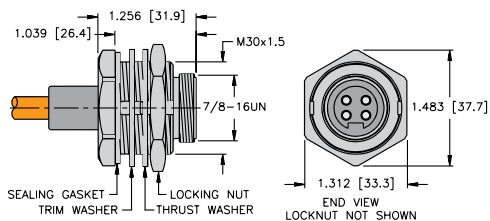

RSFPV ..

Page P23

6

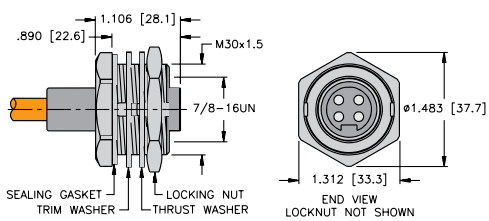

RKFPV ..

Page P23

We reserve the right to make technical alterations without prior notice.

Specifications

Overmold: TPU
Coupling Nut: Nickel Plated CuZn or Stainless Steel
Contact Carrier: TPU or POM (Nylon)
Contacts: Gold Plated CuZn

Protection: NEMA 1, 3, 4, 6P and IEC IP 68
Rated Voltage: 250 V
Rated Current: 4 A
Ambient Temperature: -40 °C to +105 °C (-40 °F to +221 °F)

7

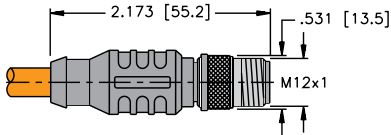

RSCV ..

Page P22

8

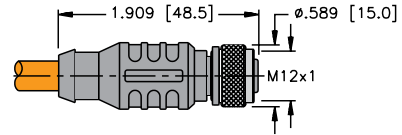

RKCV ..

Page P22

9

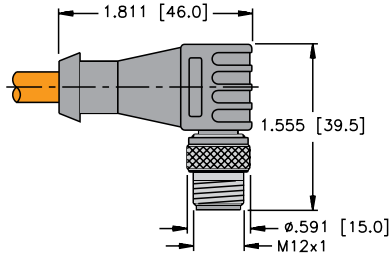

WSCV ..

Page P22

10

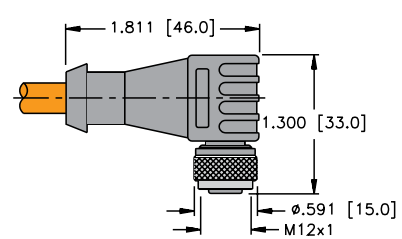

WKCV ..

Page P22

11

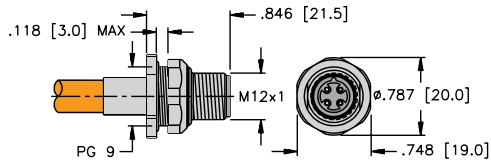

FSFDV ..

Page P23

12

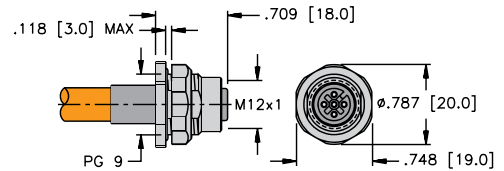

FKFDV ..

Page P23

We reserve the right to make technical alterations without prior notice.

PROFIBUS®-PA Connectivity

PROFIBUS® –PA Physical Media Connectivity

PROFIBUS-PA, (7/8-16 UN) Minifast® Male Receptacles

- Provides Quick Connection to Field Devices
- Available for 1/2-14 NPT, 1/2-14 NPSM, 3/4-14 NPT and M20 Threads



Housing Style	Female Part Number	Male Part Number	Features	Pinout
<p>RKFV 48-*M/14.5</p>	RKFV 48-*M/14.5	RSFV 48-*M/14.5	Nickel Plated CuZn or Stainless Steel 600 V, 9 A, -40 °C to +105 °C, 1/2-14 NPT full length threads	<p>Female</p>
<p>RSFV 48-*M/14.5</p>				
<p>RKFV 48-*M/14.75</p>	RKFV 48-*M/14.75	RSFV 48-*M/14.75	Nickel Plated CuZn or Stainless Steel 600 V, 9 A, -40 °C to +105 °C, 3/4-14 NPT full length threads	<ol style="list-style-type: none"> 1. BN 2. N/C 3. BU 4. GY
<p>RSFV 48-*M/14.75</p>				
<p>RKFV 48-*M/M20</p>	RKFV 48-*M/M20	RSFV 48-*M/M20	Nickel Plated CuZn or Stainless Steel 600 V, 9 A, -40 °C to +105 °C, M20x1.5 threads	<p>Male</p>
<p>RSFV 48-*M/M20</p>				

We reserve the right to make technical alterations without prior notice.

Standard cable length is 0.5 meters. Consult factory for other lengths
 Standard housing material is nickel plated brass. "RKFV .."; indicates 316 stainless steel housing.
 For locknuts to be included, add "W/LN" to the end of the part number.

PROFIBUS-PA, (7/8-16 UN) Minifast® Female Receptacles

- Provides Quick Connection to Field Devices
- Available for 1/2-14 NPT, 1/2-14 NPSM, 3/4-14 NPT and M20 Threads



Housing Style	Female Part Number	Male Part Number	Features	Pinout
<p>RKFV 48-*M</p>	RKFV 48-*M	RSFV 48-*M	Nickel Plated CuZn or Stainless Steel 600 V, 9 A, -40 °C to +105 °C, 1/2-14 NPSM threads	<p>Female</p>
<p>RSFV 48-*M</p>				<p>Male</p>

We reserve the right to make technical alterations without prior notice.

Standard cable length is 0.5 meters. Consult factory for other lengths
 Standard housing material is nickel plated brass. "RKFV .."; indicates 316 stainless steel housing.
 For locknuts to be included, add "W/LN" to the end of the part number.

PROFIBUS®-PA Connectivity

PROFIBUS® –PA Physical Media Connectivity

PROFIBUS-PA, (M12x1) Eurofast® Male Receptacles

- Mounted Quick Connection to Enclosures
- Available for 1/2-14 NPT, 1/2-14 NPSM, 3/4-14 NPT and M20 Threads



Housing Style	Female Part Number	Male Part Number	Features	Pinout
<p>FKV 48-*M/14.5</p>	FKV 48-*M/14.5	FSV 48-*M/14.5	Nickel Plated CuZn or Stainless Steel 250 V, 4 A, -40 °C to +105 °C, 1/2-14 NPT full length threads	<p>Female</p>
<p>FSV 48-*M/14.5</p>				
<p>FKV 48-*M/14.75</p>	FKV 48-*M/14.75	FSV 48-*M/14.75	Nickel Plated CuZn or Stainless Steel 250 V, 4 A, -40 °C to +105 °C, 3/4-14 NPT full length threads	<ol style="list-style-type: none"> 1. BN 2. N/C 3. BU 4. GY
<p>FSV 48-*M/14.75</p>				
<p>FKV 48-*M</p>	FKV 48-*M/M20	FSV 48-*M/M20	Nickel Plated CuZn or Stainless Steel 250 V, 4 A, -40 °C to +105 °C, M20x1.5 threads	<p>Male</p>
<p>FKV 48-*M</p>				

We reserve the right to make technical alterations without prior notice.

Standard cable length is 0.5 meters. Consult factory for other lengths
 Standard housing material is nickel plated brass. "RKFV .."; indicates 316 stainless steel housing.

PROFIBUS-PA, (M12x1) Eurofast® Female Receptacles

- Mounted Quick Connection to Enclosures
- Available for 1/2-14 NPT, 1/2-14 NPSM, 3/4-14 NPT and M20 Threads



Housing Style	Female Part Number	Male Part Number	Features	Pinout
<p>FKV 48-*M</p>	FKV 48-*M	FSV 48-*M	Nickel Plated CuZn or Stainless Steel 250 V, 4 A, -40 °C to +105 °C, PG 9 threads	<p>Female</p>
<p>FSV 48-*M</p>				<p>Male</p>

Standard cable length is 0.5 meters. Consult factory for other lengths
 Standard housing material is nickel plated brass. "RKFV .."; indicates 316 stainless steel housing.

We reserve the right to make technical alterations without prior notice.

PROFIBUS®-PA Connectivity

PROFIBUS® –PA Physical Media Connectivity

PROFIBUS-PA, Terminating Resistors

- Terminating Resistors stabilize and minimize reflections on the Bus Line
- A Terminating Resistor is required at the beginning and end of the Main Bus Line



Housing Style	Part Number	Features	Pinout
	RSV 48 TR	Nickel plated brass or stainless steel, 300 V, 9 A, -40 °C to +75 °C, male Minifast® connector	<p>Male</p>
	RSEV 48-TR	Nickel plated brass or stainless steel, 250 V, 4 A, -40 °C to +75 °C, male Eurofast® connector	<p>Male</p>

PROFIBUS-PA, Feed Through Connectors

- Receptacles provide transition from Male to Female Connectors
- Available for Bulkhead and Feed Through applications



Housing Style	Part Number	Features	Pinout
	RSFV RKFV 48/22	Stainless steel, 300 V, 9 A, -40 °C to +75 °C, straight male/female feed through, for use with molded Minifast cordsets	<p>Female</p> <p>Male</p>
	FKV FSV 48/M12	Stainless steel, 250 V, 4 A, -40 °C to +75 °C, straight male/female connector, for pre-molded Eurofast cables	<p>Female</p> <p>Male</p>

Panel Cutout RSFV RKFV 48/22

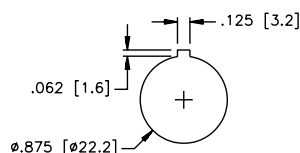

Panel Cutout WFS

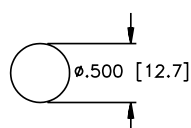

We reserve the right to make technical alterations without prior notice.

PROFIBUS-PA, Tees

- Creates a Drop or Branch from the Main Bus Line
- Minifast® Connectors on Bus or Drop Lines



Housing Style	Part Number	Features	Wiring Diagrams
	RSV-2RKV 48	TPU, 250 V, 4 A, -40 °C to +75 °C, data, ground, shield, stainless steel, coupling nuts	
	RSV FKV RKV 48	TPU, 250 V, 4 A, -40 °C to +75 °C, Minifast to Eurofast® drop, data, ground, shield, stainless steel coupling nuts	
	RSCV RKCVC 48	TPU, 250 V, 4 A, -40 °C to +105 °C, stainless steel coupling nuts	

We reserve the right to make technical alterations without prior notice.

PROFIBUS®-PA Connectivity

Pinouts

Minifast		Eurofast	
Male	Female	Male	Female

PROFIBUS® –PA Physical Media Connectivity

PROFIBUS-PA, Gender Changer

- Allows quick and easy changes from Male to Female Minifast® from Connectors



Housing Style	Part Number	Features
	RKV RKV 48	TPU, 250 V, 4 A, -40 °C to +75 °C, changes female cordset to male receptacle

PROFIBUS-PA, Conversion Connector

- Allows Quick and Easy Changes from Minifast® to Eurofast® Connectors



Housing Style	Part Number	Features	Wiring Diagrams
	RSM 48-FK 4.4	Nickel plated brass CuZn or Stainless Steel, 250 V, 4 A, -40 °C to +80 °C, female Eurofast, male Minifast, 4-pin	

We reserve the right to make technical alterations without prior notice.

Pinouts

Minifast		Eurofast
Male	Female	Female

PROFIBUS-PA, Minifast® Field Wireable Connectors

- Screw Terminals accept up to 16 AWG Conductors



We reserve the right to make technical alterations without prior notice.

Housing Style	Female Part Number	Female Part Number	Features	Pinout
<p>BK 414..</p>	BK 4140-0/9	BS 4140-0/9	Plastic, TPU (cable grip: Plastic, PU), Anodized Aluminum, PG 0/9 cable gland accepts 6-8 mm cable diameter, -40 °C to +90 °C (-40 °F to +194 °F), 250 V, 9 A, mates with all 4-pin Minifast cordsets and receptacles	<p>Female</p>
<p>BS 414..</p>				
<p>BSV 414..</p>	BKV 4140-0/9	BSV 4140-0/9	Glass filled nylon, stainless steel coupling nut, PG 0/9 cable gland accepts 6-8 mm cable diameter, -40 °C to +90 °C (-40 °F to +194 °F), 300 V, 9 A, mates with all 4-pin Minifast cordsets and receptacles	<p>Male</p>
<p>BKV 414..</p>				
<p>BKV 414..</p>	BKV 4140-0/16	BSV 4140-0/16	Glass filled nylon, stainless steel coupling nut, PG 16 cable gland accepts 10-12 mm cable diameter, -40 °C to +90 °C (-40 °F to +194 °F), 600 V, 9 A, mates with all 4-pin Minifast cordsets and receptacles	<p>Male</p>
<p>BSV 414..</p>				

PROFIBUS®-PA Connectivity

PROFIBUS® –PA Physical Media Connectivity

PROFIBUS-PA, Eurofast® Field Wireable Connectors

- Screw Terminals accept up to 18 AWG Conductors



Housing Style	Female Part Number	Female Part Number	Features	Pinout
<p>B 814..</p> <p>BS 814..</p>	B 8141-0/PG9	BS 8141-0/PG9	PBT, Black, PG 9 cable gland, accepts 4-8 mm cable diameter, 85 °C, 125 V, 4 A, mates with standard key 4-pin Eurofast cordsets and receptacles	<p>Female</p>
<p>B 824..</p> <p>BS 824..</p>	B 8241-0/PG9	BS 8241-0/PG9		

We reserve the right to make technical alterations without prior notice.

Part Number Keys	R4
Cordsets	R7
Receptacles	R15
Field Wireables	R19
Accessories	R21

Features

- Cables that meet the requirements of EN 50295 for communication up to 167 KBAUD
- ITC-ER/PLTC-ER rated cable (CSA FT4)
- Oil resistant II and sunlight resistant
- 7/8 and M12 connectors
- Up to 9 Amps and 600 Volt rated
- IP67/IP69K rated



AS-interface System Description

AS-interface (commonly referred to as AS-I) is a low-level I/O interface system. It was originally intended to be a simple, low cost system that would be easy to install and maintain. With that philosophy in mind, the original developers designed AS-I as a discrete-only two-wire system. It incorporated features like automatic station addressing, and power and data were carried on a single untwisted pair of wires.

As the demand for AS-I grew, so did the demand for more complex devices. The next major version of AS-I, v2.1, extended the protocol to include seamless transfer of analog data, transmission of simple diagnostic data, and an extended addressing scheme that effectively doubled the number of stations allowed on the network. The newest version of AS-I, v3.0, has gone even further, allowing more options for analog data and much more detailed diagnostic information to be communicated. New versions of AS-I are backward compatible and support slaves from earlier versions. Additionally, AS-I was one of the first network systems to incorporate a safety protocol, allowing emergency-stop and machine-stop systems to be seamlessly integrated with the network.

AS-I can be used as a stand alone network or can be connected to a higher level system, such as DeviceNet™ or PROFIBUS®-DP, through a gateway. The gateway acts as a slave to the higher system and a master to the AS-I system.

Cordsets

Turck offers a complete line of molded AS-I cordsets to facilitate network installation, resulting in a faster start-up and fewer wiring errors. The bus and drop cables are specially designed foil-shielded, high-flex cables with very low inductance and capacitance to minimize propagation delay time. AS-I cables consist of a single untwisted and unshielded wire pair that carries both 30 VDC power and the network data. AS-I was originally designed for use with flat cable using an insulation displacement connection technology, but the use of round cables with sealed connectors has become more common. Turck provides both cable options.

Maximum Ratings

The AS-I system uses a freeform layout topology. Up to 100 m of cable can be used on a segment before a repeater or tuner needs to be installed to allow the network to be extended beyond the 100 m limit. No terminating resistors are required.

Typical System Configuration

Basic Parts List

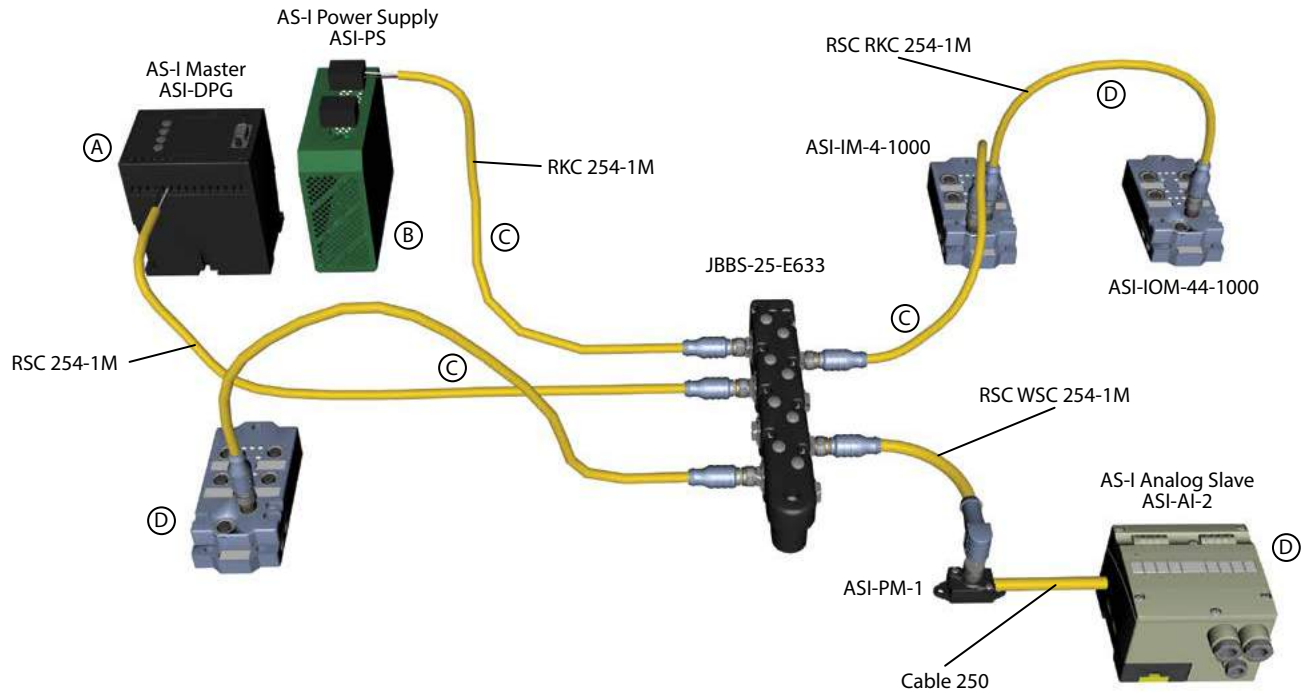

A typical AS-I system consists of the following parts:

- A - Master
- B - AS-I Power Supply
- C - AS-I Cable (See N2)
- D - AS-I I/O Modules (or Slaves)

AS-I stations require a network master (also called a scanner) to interface the stations to the host controller. In some cases the scanner and controller are packaged as a single unit; in other cases the scanner acts as a gateway to a higher level network or to a PLC. Turck AS-I stations are designed to be fully compatible with AS-I equipment from other manufacturers.

AS-interface® Physical Media Connectivity

Minifast® Cordset Part Number Key

Part Number Keys are to assist in IDENTIFICATION ONLY. Consult factory for catalog items not identified.

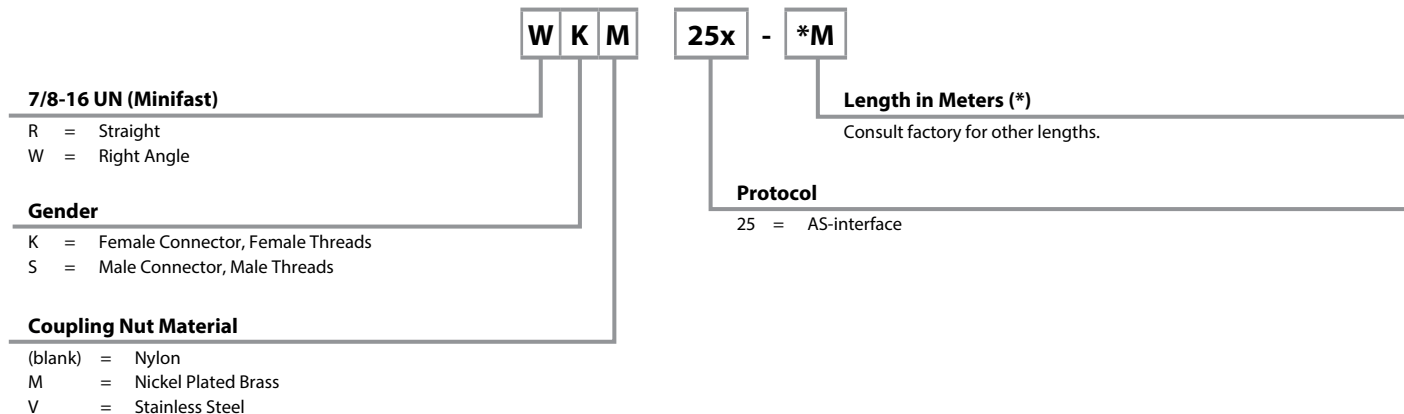

Minifast Receptacle Part Number Key

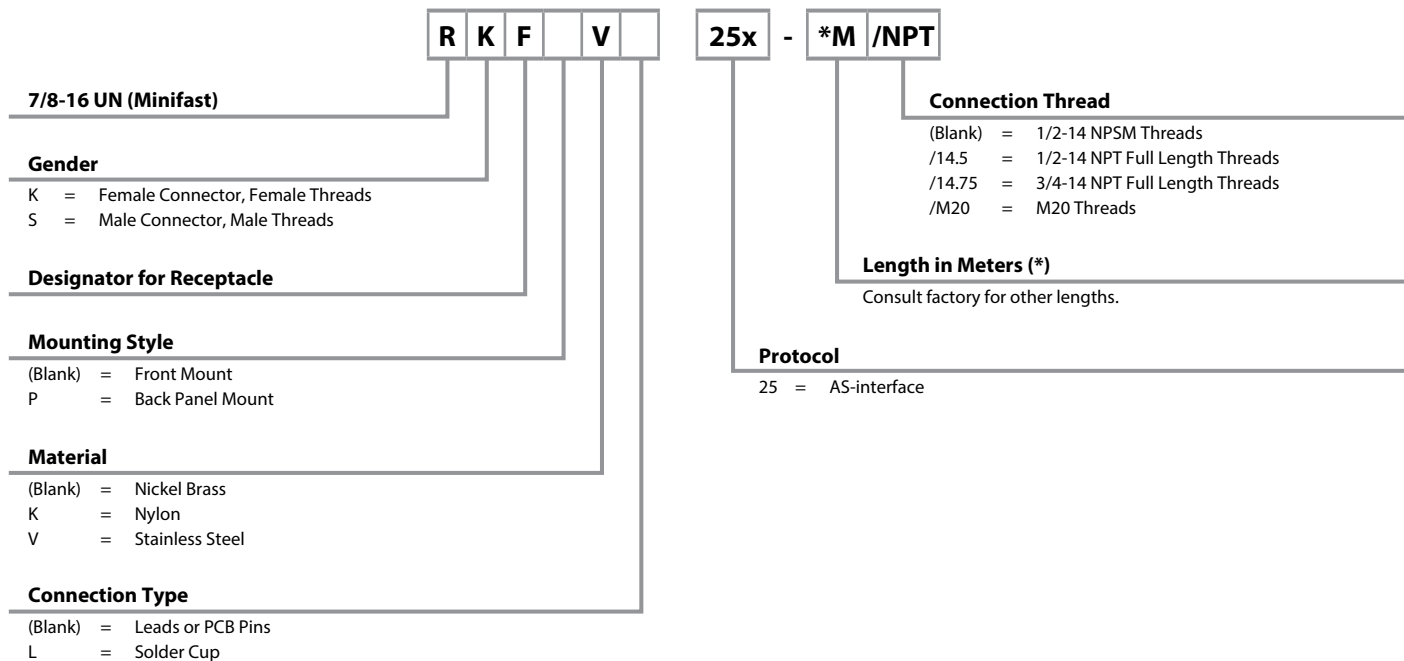

Eurofast® Cordset Part Number Key

Part Number Keys are to assist in IDENTIFICATION ONLY. Consult factory for catalog items not identified.

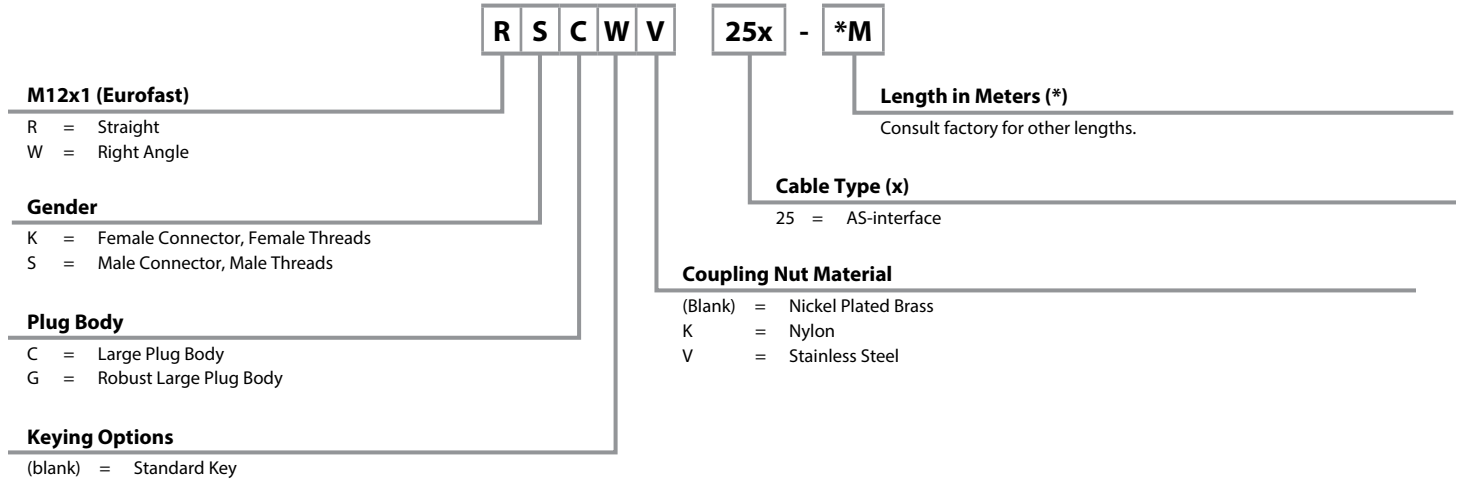

Eurofast Receptacle Part Number Key

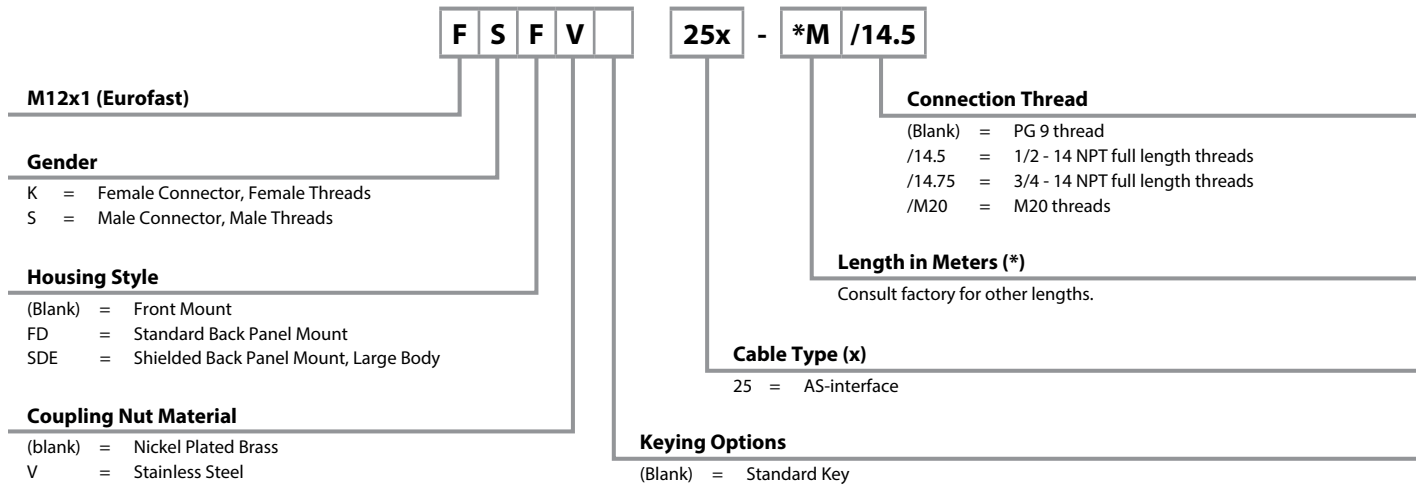

AS-interface, Cable Specifications

- AS-interface Cable that meets the requirements of EN50295e for communication up to 167 Kbaud
- Maximum cable length per segment is 100 meters

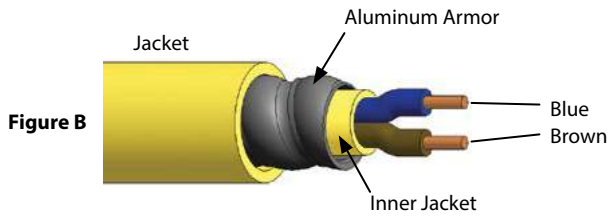
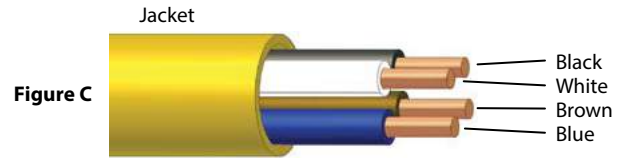
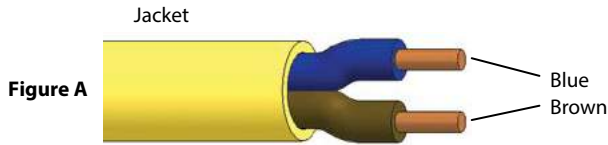

We reserve the right to make technical alterations without prior notice.



Type	Approvals	Data Pair		Outer Jacket	Bulk Cable Part Number / Weight/300 M
		AWG Color Code	DCR (/1000 feet) Insulation	Material Color Nominal O.D.	
254 105 °C, 600 V	c(UL) 1309 MS, ITC-ER DB, CIC/TC, FT1 FT4	2X16 AWG BU/BN	4.1 Ohms PVC	PVC, YELLOW, 7.2 mm (.285 in)	RB50852-*M, 49 lbs.
254BK 105 °C, 600 V	c(UL) 1309 MS, ITC-ER DB, CIC/TC, FT1 FT4	2X16 AWG BU/BN	4.1 Ohms PVC	PVC, BLACK, 7.2 mm (.285 in)	RB51029-*M, 49 lbs.
254B 105 °C, 600 V	c(UL) 1309 MS, ITC-ER DB, CIC/TC, FT1 FT4	2X16 AWG BU/BN	4.1 Ohms PVC	PVC, BLUE, 7.2 mm (.285 in)	RB50962-*M, 49 lbs.
255A 105 °C, 300 V	UL ITC-ER DB CSA ACIC HL-ABCD, FT1 FT4	2X16 AWG BU/BN	4.1 Ohms PVC	Armor, PVC YELLOW, 15.2 mm (.600 in)	RB50966-*M, 173 lbs.
2544 105 °C, 600 V	c(UL) 1309 MS, ITC-ER DB, CIC/TC, FT1 FT4	4X16 AWG BN/WH/BU/BK	4.1 Ohms PVC	PVC, YELLOW, 8.5 mm (.335 in)	RB51875-*M, 81 lbs.

* Indicates length in meters.
Standard spool lengths are 30, 75, 100, 150, 200, 225, 300 meters. Consult factory for other lengths.

AS-interface® Media

AS-interface® Physical Media Connectivity

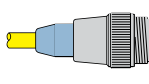
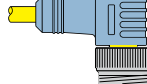
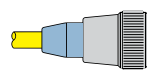
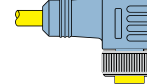
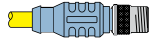
AS-interface, Cable and Cordset Selection Matrix

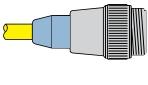
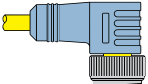
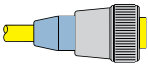
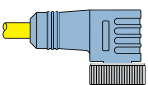
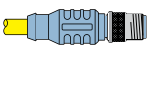
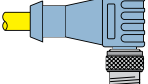
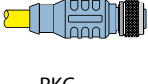
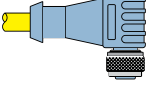
		Minifast®				Eurofast®
		Male		Female		Male
		1  RSM	2  WSM	3  RKM	4  WKM	7  RSC
 Bare		RSM 25x-*M	WSM 25x-*M	RKM 25x-*M	WKM 25x-*M	RSC 25x-*M
Minifast (Male)	1  RSM	RSM RSM 25x-*M	RSM WSM 25x-*M	RSM RKM 25x-*M	RSM WKM 25x-*M	RSM RSC 25x-*M
	2  WSM		WSM WSM 25x-*M	WSM RKM 25x-*M	WSM WKM 25x-*M	WSM RSC 25x-*M
Minifast (Female)	3  RKM			RKM RKM 25x-*M	RKM WKM 25x-*M	RKM RSC 25x-*M
	4  WKM				WKM WKM 25x-*M	WKM RSC 25x-*M
Eurofast (Male)	7  RSC					RSC RSC 25x-*M
	8  WSC					
Eurofast (Female)	9  RKC					
	10  WKC					

We reserve the right to make technical alterations without prior notice.

See pages R10 - R11 for dimensional drawings.

* Indicates length in meters.

x Indicates cable type.

Standard cable lengths are 1, 2, 4, 6, 8, 10, 15...50 meters. Consult factory for other lengths.

For stainless steel coupling nuts change part number RSM ... to RSV, WSM ... to WSV. For Eurofast Armorfast® cable RSC ... to RSA.

AS-interface, Cable and Cordset Selection Matrix

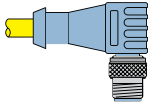
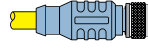
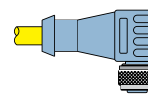
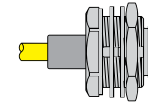
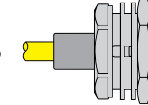
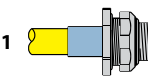
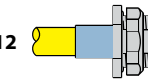
Eurofast®			Minifast® Bulkhead		Eurofast Bulkhead	
Male	Female		Male	Female	Male	Female
8 	9 	10 	5 	6 	11 	12 
WSC	RKC	WKC	RSFP	RKFP	FSFD	FKFD
WSC 25x-*M	RKC 25x-*M	WKC 25x-*M	RSFP 25x-*M	RKFP 25x-*M	FSFD 25x-*M	FKFD 25x-*M
RSM WSC 25x-*M	RSM RKC 25x-*M	RSM WKC 25x-*M	RSM RSFP 25x-*M	RSM RKFP 25x-*M	RSM FSFD 25x-*M	RSM FKFD 25x-*M
WSM WSC 25x-*M	WSM RKC 25x-*M	WSM WKC 25x-*M	WSM RSFP 25x-*M	WSM RKFP 25x-*M	WSM FSFD 25x-*M	WSM FKFD 25x-*M
RKM WSC 25x-*M	RKM RKC 25x-*M	RKM WKC 25x-*M	RKM RSFP 25x-*M	RKM RKFP 25x-*M	RKM FSFD 25x-*M	RKM FKFD 25x-*M
WKM WSC 25x-*M	WKM RKC 25x-*M	WKM WKC 25x-*M	WKM RSFP 25x-*M	WKM RKFP 25x-*M	WKM FSFD 25x-*M	WKM FKFD 25x-*M
RSC WSC 25x-*M	RSC RKC 25x-*M	RSC WKC 25x-*M	RSC RSFP 25x-*M	RSC RKFP 25x-*M	RSC FSFD 25x-*M	RSC FKFD 25x-*M
WSC WSC 25x-*M	WSC RKC 25x-*M	WSC WKC 25x-*M	WSC RSFP 25x-*M	WSC RKFP 25x-*M	WSC FSFD 25x-*M	WSC FKFD 25x-*M
	RKC RKC 25x-*M	RKC WKC 25x-*M	RKC RSFP 25x-*M	RKC RKFP 25x-*M	RKC FSFD 25x-*M	RKC FKFD 25x-*M
		WKC WKC 25x-*M	WKC RSFP 25x-*M	WKC RKFP 25x-*M	WKC FSFD 25x-*M	WKC FKFD 25x-*M

We reserve the right to make technical alterations without prior notice.

AS-interface® Media

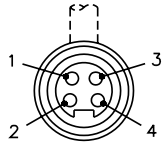
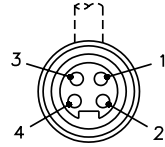
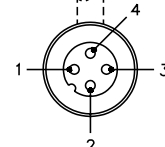
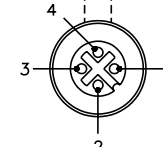
Minifast		Pinouts	Eurofast	
Male	Female		Male	Female
		1. Brown (+ Voltage) 2. N/C 3. Blue (- Voltage) 4. N/C		

Specifications

Overmold:	TPU	Protection:	NEMA 1, 3, 4, 6P and IEC IP 67
Coupling Nut:	Nickel Plated CuZn or Stainless Steel	Rated Voltage:	300 V
Contact Carrier:	TPU (Polyurethane)	Rated Current:	9 A
Contacts:	Gold Plated CuZn	Ambient Temperature:	-40 °C to +105 °C (-40 °F to +221 °F)

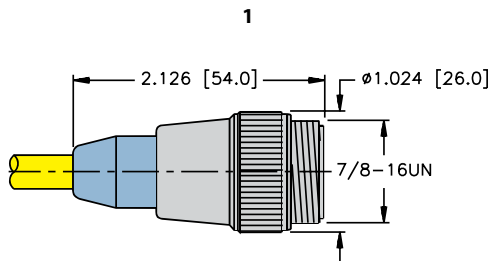

RSM ..

Page R8

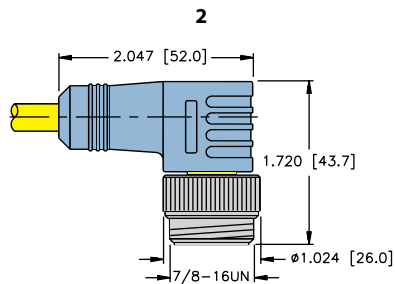

WSM ..

Page R8

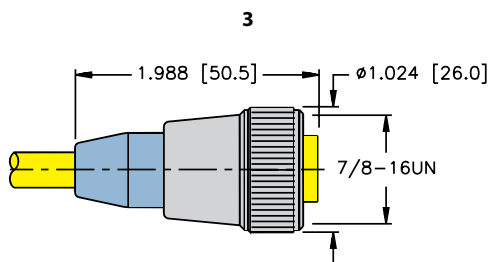

RKM ..

Page R8

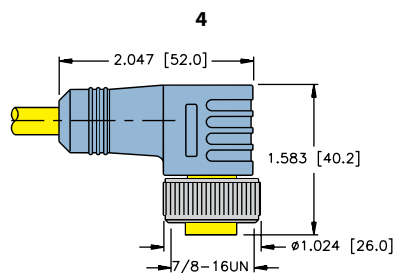

WKM ..

Page R8

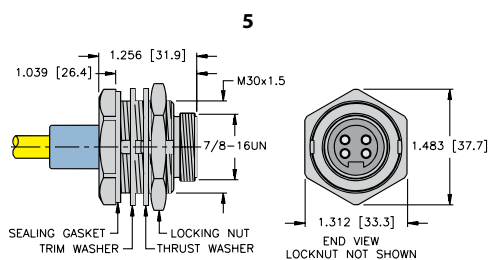

RSFP ..

Page R9

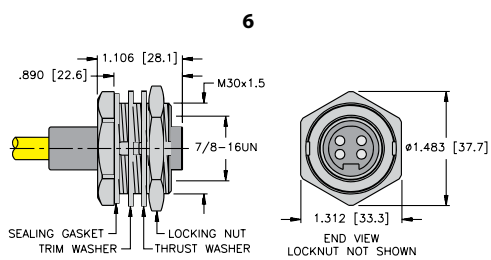

RKFP ..

Page R9

We reserve the right to make technical alterations without prior notice.

Specifications

Overmold: TPU
Coupling Nut: Nickel Plated CuZn or Stainless Steel
Contact Carrier: TPU or POM (Nylon)
Contacts: Gold Plated CuZn

Protection: NEMA 1, 3, 4, 6P and IEC IP 68
Rated Voltage: 250 V
Rated Current: 4 A
Ambient Temperature: -40 °C to +105 °C (-40 °F to +221 °F)

We reserve the right to make technical alterations without prior notice.

7

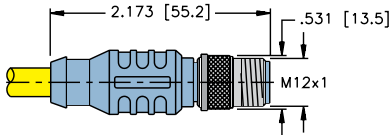

RSC ..

Page R8

8

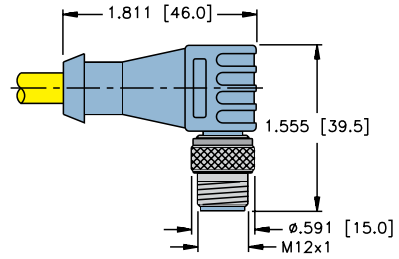

WSC ..

Page R8

9

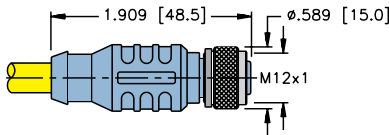

RKC ..

Page R8

10

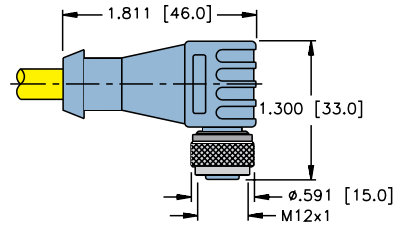

WKC ..

Page R8

11

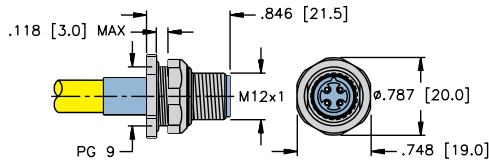

FSFD ..

Page R9

12

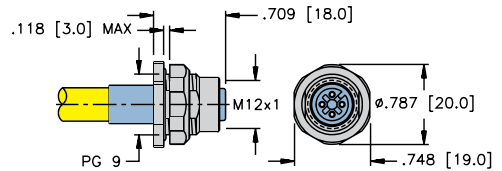

FKFD ..

Page R9

AS-interface® Media

AS-interface® Physical Media Connectivity

AS-interface, Tees

- Creates a Drop or Branch from the Main Bus Line
- Available in Minifast® or Eurofast® Bus or Drop Lines



Housing Style	Part Number	Features	Wiring Diagrams
	RSV 2RKV 25	TPU (Polyurethane), stainless steel, 250 V, 4 A (Eurofast), 9 A (Minifast), -40 °C to +80 °C, Minifast drop connector	
	RSCV 2RKC 25	TPU (Polyurethane), stainless steel, 250 V, 4 A (Eurofast), -30 °C to +90 °C, Eurofast female drop connector	
	RKC 2RSC 25	TPU (Polyurethane), stainless steel, 250 V, 4 A (Eurofast), -30 °C to +90 °C, Eurofast male drop connector, nickel plated brass	
	RSCV WKCV 25	TPU (Polyurethane), stainless steel, 250 V, 4 A (Eurofast), -40 °C to +105 °C, Eurofast male elbow	
	RSC RKC 25	TPU (Polyurethane), stainless steel, 250 V, 4 A (Eurofast), -40 °C to +105 °C, Eurofast male	

We reserve the right to make technical alterations without prior notice.

Minifast		Pinouts	Eurofast	
Male	Female		Male	Female
		1. Brown (+ Voltage) 2. N/C 3. Blue (- Voltage) 4. N/C		

AS-interface, Gender Changers and Elbow Connectors

- Allows Quick and Easy Change from Male to Female Minifast® Connectors



Housing Style	Part Number	Specs	Application	Wiring Diagrams
	RKM RKM 25	TPU (Polyurethane) 250 V, 9 A -40 °C to +80 °C	Minifast Female Gender Changer • Male cordset to female receptacle	

We reserve the right to make technical alterations without prior notice.

AS-interface® Media

Minifast	Pinouts	Eurofast
Male 	1. Brown (+ Voltage) 2. N/C 3. Blue (- Voltage) 4. N/C	Female

AS-interface® Physical Media Connectivity

AS-interface, Eurofast® Flat Cable Adapter

- Allows the mixing of standard AS-I Flat Cable with Eurofast Round Cable in same system
- May be needed when going from a dry to a wet environment or an area where better sealing and Rugged Connectors are required

Housing Style	Part Number	Features	Pinout
	ASI-PM-1 BW1239	TPU (Polyurethane) 250 V, 4 A -40 °C to +75 °C	Female

	Type	Approvals	Data Pair		Outer Jacket Material Color Nominal O.D.	Bulk Cable Part Number / Weight/300 M
			AWG Color Code	DCR (/1000 feet) Insulation		
	2501 105 °C, 300 V	UL 2103 CSA AWM	2X16 AWG BU/BN	4.1 Ohms TPE	TPE, YELLOW, Flat	RB51822-*M, 42 lbs.
	2511 105 °C, 300 V	UL 2103 CSA AWM	2X16 AWG BU/BN	4.1 Ohms TPE	TPE, BLACK, Flat	RB51821-*M, 42 lbs.
	253G 75 °C, 300 V	UL PLTC CSA AWM II A/B, FT4	2X16 AWG BU/BN	4.1 Ohms PO	PVC, GRAY, Flat	RB51240-*M, 42 lbs.
	253BK 75 °C, 300 V	UL PLTC CSA AWM II A/B, FT4	2X16 AWG BU/BN	4.3 Ohms PO	PVC, BLACK, Flat	RB51241-*M, 42 lbs.
	253Y 75 °C, 300 V	UL PLTC CSA AWM II A/B, FT4	2X16 AWG BU/BN	4.3 Ohms PO	PVC, YELLOW, Flat	RB51242-*M, 42 lbs.

* Indicates length in meters.
Standard spool lengths are 30, 75, 100, 150, 200, 225, 300 meters. Consult factory for other lengths.

We reserve the right to make technical alterations without prior notice.

AS-interface, Minifast® Male Receptacles

- Provides Quick Connection to Field Devices or Enclosures
- Available for 1/2-14 NPT, 1/2-14 NPSM, 3/4-14 NPT and M20 Threads
- (7/8-16 UN) Minifast Connection



We reserve the right to make technical alterations without prior notice.

Housing Style	Female Part Number	Male Part Number	Features	Pinout
<p>RKF 25.../14.5</p>	RKF 25-*M/14.5	RSF 25-*M/14.5	Nickel plated CuZn or stainless steel 300 V, 9 A, -40 °C to +105 °C, 1/2-14 NPT full length threads	<p>Female</p>
<p>RSF 25.../14.5</p>				
<p>RKF 25.../14.75</p>	RKF 25-*M/14.75	RSF 25-*M/14.75	Nickel plated CuZn or stainless steel 300 V, 9 A, -40 °C to +105 °C, 3/4-14 NPT full length threads	<p>1. BN 2. N/C 3. BU 4. N/C</p>
<p>RSF 25.../14.75</p>				
<p>RKF 25.../M20</p>	RKF 25-*M/M20	RSF 25-*M/M20	Nickel plated CuZn or stainless steel 300 V, 9 A, -40 °C to +105 °C, M20x1.5 threads	<p>Male</p>
<p>RSF 25.../M20</p>				

Standard cable length is 0.5 meters. Consult factory for other lengths.
 Standard housing material is nickel plated brass. "RKF .."; "RKFV .." indicates 316 stainless steel housing.
 For locknuts to be included, add "W/LN" to the end of the part number.

AS-interface® Media

AS-interface® Physical Media Connectivity

AS-interface, Minifast® Male Receptacles

- Provides Quick Connection to Field Devices or Enclosures
- Available for 1/2-14 NPT, 1/2-14 NPSM, 3/4-14 NPT and M20 Threads
- (7/8-16 UN) Minifast Connection



Housing Style	Female Part Number	Male Part Number	Features	Pinout
<p>RKF ..</p>	RKF 25-*M	RSF 25-*M	Nickel plated CuZn or stainless steel 300 V, 9 A -40 °C to +105 °C, 1/2-14 NPSM threads	<p>Female</p>
<p>RSF ..</p>				<p>Male</p>

Standard cable length is 0.5 meters. Consult factory for other lengths.
 Standard housing material is nickel plated brass. "RKF .."; "RKFV .." indicates 316 stainless steel housing.
 For locknuts to be included, add "W/LN" to the end of the part number.

We reserve the right to make technical alterations without prior notice.

AS-interface, Eurofast® Male Receptacles

- Mounted for Quick Connection to Enclosures
- (M12x1) Eurofast Connectors



We reserve the right to make technical alterations without prior notice.

Housing Style	Female Part Number	Male Part Number	Features	Pinout
<p>FK 25...14.5</p>	FK 25-*M/14.5	FS 25-*M/14.5	Nickel plated CuZn or stainless steel, 250 V, 4 A, -40 °C to +105 °C, 1/2-14 NPT full length threads	
<p>FS 25...14.5</p>				
<p>FK 25...14.75</p>	FK 25-*M/14.75	FS 25-*M/14.75	Nickel plated CuZn or stainless steel, 250 V, 4 A, -40 °C to +105 °C, 3/4-14 NPT full length threads	<ol style="list-style-type: none"> 1. BN 2. N/C 3. BU 4. N/C
<p>FS 25...14.75</p>				
<p>FK 25.../M20</p>	FK 25-*M/M20	FS 25-*M/M20	Nickel plated CuZn or stainless steel, 250 V, 4 A, -40 °C to +105 °C, M20x1.5 threads	
<p>FS 25.../M20</p>				

Standard cable length is 0.5 meters. Consult factory for other lengths.
 Standard housing material is nickel plated brass. "RKF .."; "RKFV .." indicates 316 stainless steel housing.

AS-interface® Media

AS-interface® Physical Media Connectivity

AS-interface, Eurofast® Male Receptacles

- Mounted for Quick Connection to Enclosures
- (M12x1) Eurofast Connectors



Housing Style	Female Part Number	Male Part Number	Features	Pinout
<p>FK 25...</p> <p>FS 25...</p>	FK 25-*M	FS 25-*M	Nickel plated CuZn or stainless steel, 250 V, 4 A, -40 °C to +105 °C, PG 9 threads	<p>Female</p> <p>Male</p>

Standard cable length is 0.5 meters. Consult factory for other lengths.
 Standard housing material is nickel plated brass. "RKF .."; "RKFV .." indicates 316 stainless steel housing.

We reserve the right to make technical alterations without prior notice.

AS-interface, Minifast® Field Wireable Connectors with Labels

- Allows for Quick Connection when Pre-Molded Cables are not available
- Available for Male and Female Connectors
- Color Coded Wire Connection for AS-interface



Housing Style	Female Part Number	Male Part Number	Features	Pinout
<p>BK 41..</p> <p>BS 41..</p>	BK 4140-0/9/ASI	BS 4140-0/9/ASI	Glass filled nylon, PG 9 cable gland, accepts 6-8 mm cable diameter, screw terminals, 90 °C, 250 V, 9 A, mates with standard, 4-pin cordsets and receptacles	<p>Female</p>
<p>BKV 41..</p> <p>BSV 41..</p>	BKV 4140-0/9/ASI	BSV 4140-0/9/ASI		

We reserve the right to make technical alterations without prior notice.

AS-interface® Media

AS-interface® Physical Media Connectivity

AS-interface, Eurofast® Field Wireable Connectors with Labels

- Allows for Quick Connection when Pre-Molded Cables are not available
- Available for Male and Female Connectors
- Color Coded Wire Connection for AS-interface



Housing Style	Female Part Number	Male Part Number	Features	Pinout
<p>B 81..</p> <p>BS 81..</p>	B 8141-0/PG9/ASI	BS 8141-0/PG9/ASI	PBT, black, PG 9 cable gland, accepts 6-8 mm cable diameter, screw terminals, 85 °C, 250 V, 4 A, mates with standard, 4-pin cordsets and receptacles	<p>Female</p>
<p>B 82..</p> <p>BS 82..</p>	B 8241-0/PG9/ASI	BS 8241-0/PG9/ASI		<p>Male</p>

We reserve the right to make technical alterations without prior notice.

AS-interface, Gender Changer

- Allows quick and easy change from Male to Female and (7/8-16 UN) Minifast® to (M12x1) Eurofast® Connectors



Housing Style	Part Number	Features	Wiring Diagrams
	RSM 25-FK 4.5	Nickel plated CuZn or stainless steel, 250 V, 4 A, 40 °C to +75 °C, female Eurofast, male Minifast, 4-pin	

We reserve the right to make technical alterations without prior notice.

AS-interface® Media

Pinouts

Minifast	Eurofast
Male	Female

AS-interface® Physical Media Connectivity

FOUNDATION™ fieldbus, Conduit Adapters

- Converts Standard Conduits to Quick Disconnect
- Fiberglass Reinforced Nylon Housings
- Nickel Plated Brass Connectors available
- 3/4" Form 8 or Mark 9
- 1" Form 7 available upon request
- Gasket and Mounting Screws provided
- IP67



Housing Style	1 Port Part Number	2 Port Part Number	Specifications	Pinout
	BCA-49-E123	BCA-49-E223	3/4" Form 8 or Mark 9, M12 x 1 stainless steel connectors	Female
	BCA-49-M123	BCA-49-M223	3/4" Form 8 or Mark 9, 7/8"-16 UN stainless steel connectors	Female
	BCA-49SC-M123	BCA-49SC-M223	Short circuit protection, 3/4" Form 8 or Mark 9, 7/8"-16 UN stainless steel connectors	

We reserve the right to make technical alterations without prior notice.

Part Number Keys	S2
M12 (eurofast®)	S4
M8 (picofast®)	S42
7/8" (minifast®)	S52
1/2" (microfast®)	S66
Accessories	S70

Features

- Products for M12 Eurofast, M8 Picofast, 7/8" Minifast and 1/2 Microfast
- Consolidate up to 16 I/O signals
- AC or DC options
- PNP LED, NPN LED and non-LED offerings
- Multiple housing styles and materials



multibox®

Junction Box Connectivity Products

M12 Eurofast® Standard and Low Profile Junction Box Part Number Keys

Part Number Keys are to assist in IDENTIFICATION ONLY. Consult factory for catalog items not identified.

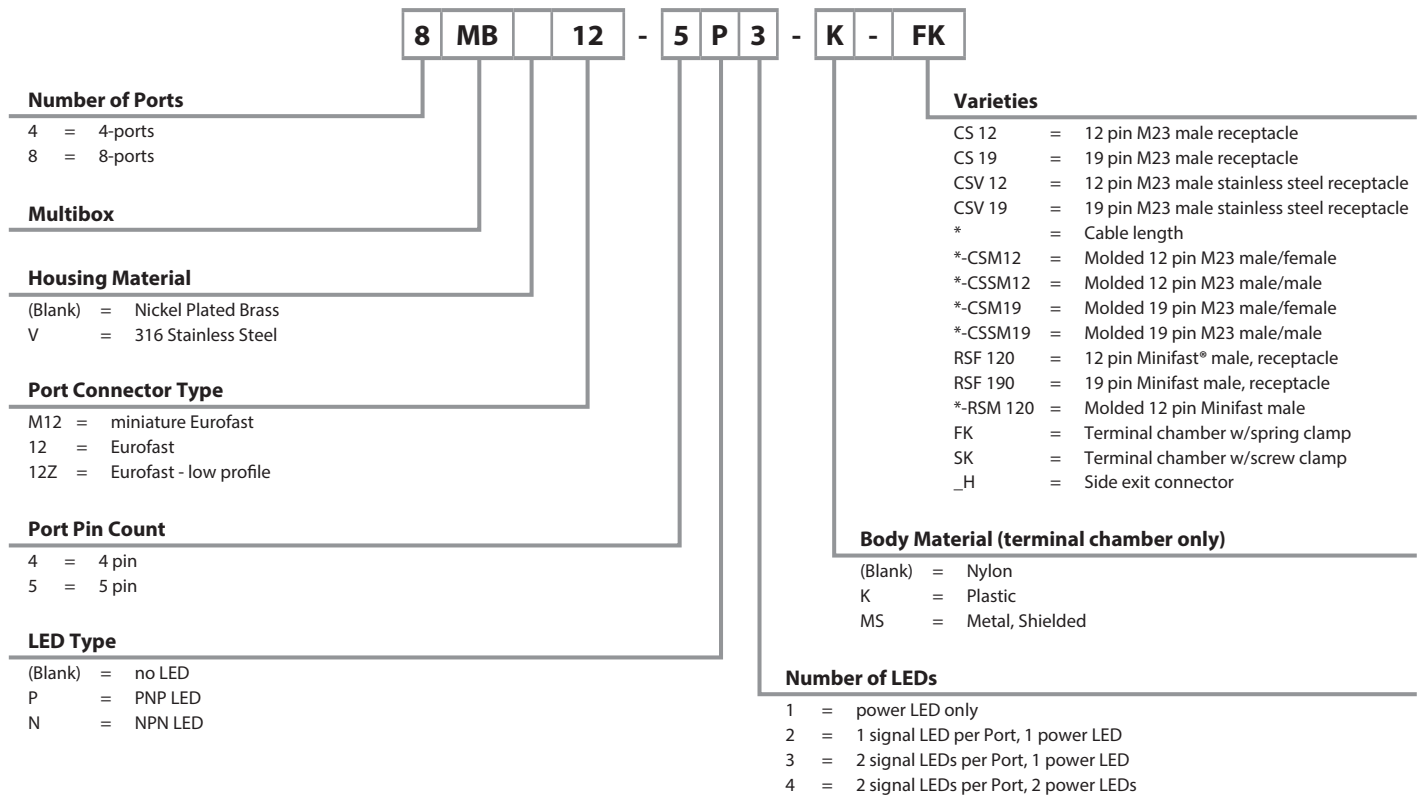
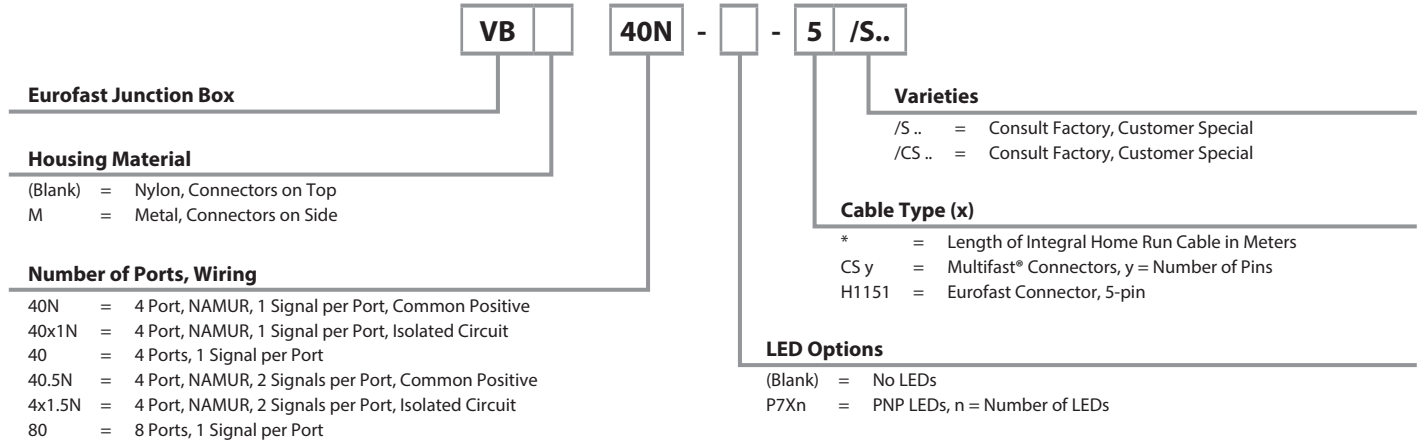

M8 Picofast® Junction Box Part Number Key

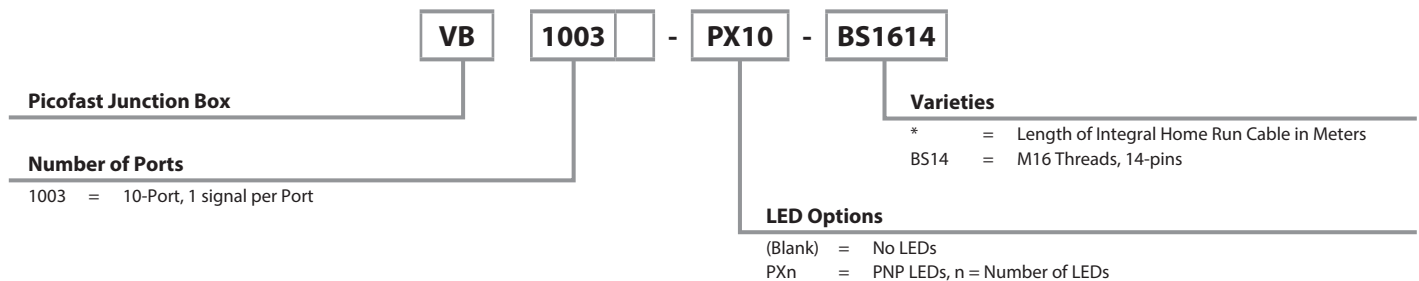

M8 Picofast® Junction Box Part Number Key

Part Number Keys are to assist in IDENTIFICATION ONLY. Consult factory for catalog items not identified.

TB - **8** **M8** **M** - **3** **P2** - **FS8** /

Picofast Junction Box

Number of Ports

- 4 = 4-Port
- 8 = 8-Port

Port Connectors

- M8 = M8 Picofast

Port Connection Type

- M = M8x1 thread
- Z = M8 Snap

Special Modifiers, /S & /CS

Homerun connector

- FS8 = 8-pin M12
- FS12 = 12-pin M12
- * = cable length in meters

Port LED Type

- (Blank) = No LEDs
- P2 = PNP LEDs (3pin only)
- N2 = NPN LEDs (3 pin ports only)

Port Type

- 3 = 3-pin ports, 1 signal per port
- 4 = 4-pin ports, 2 signals per port

7/8-16 UN Minifast® Junction Box Part Number Key

4 **RKF** **30** - **X5** - **6M** /S..

Number of Ports

- 4
- 6
- 8
- Overmolded Junction Boxes
- 6
- 7

Type of Connector / Threads

- RKF = Minifast, Female Contact Holder, Female Threads
- RXF = Minifast, Female Contact Holder, Male Threads
- MBMA = Minifast overmolded junction box

Number of Ports, Wiring

- 30 = 3-pin, Standard Wiring
- 301 = 3-pin, Series Wiring
- 40 = 4-pin, Standard Wiring
- Overmolded Junction Boxes
- 3 = 250 VAC/300 VDC
- 3A2 = 40-120 VDC, LEDs for power and signal

Varieties

- /S.. = Consult Factory, Customer Special
- /CS.. = Consult Factory, Customer Special

Cable Type (x)

- *M = Length of Integral Home Run Cable in Meters
- CS12 = Multifast® Connector, 12-pin (only overmolded option)
- B1131 = Minifast Connector, 3-pin
- B1161 = Minifast Connector, 6-pin
- RSF60 = Minifast Connector, 6-pin
- RSF70 = Minifast Connector, 7-pin
- RSF80 = Minifast Connector, 8-pin
- RSF100 = Minifast Connector, 10-pin
- RSF120 = Minifast Connector, 12-pin

LED Options

- (Blank) = No LEDs
- Xn = LEDs, n = Number of LEDs

1/2" Microfast® Junction Box Part Number Key

VBKB **40** - **X5** - **CS12** /S..

Microfast Junction Box

Number of Ports, Wiring Type

- 40 = 4 Port, 1 Signal per Port
- 60 = 6 Port, 1 Signal per Port
- 80 = 8 Port, 1 Signal per Port

Varieties

- /S.. = Consult Factory, Customer Special
- /CS.. = Consult Factory, Customer Special

Cable Type (x)

- (Number) = Length of Integral Home Run Cable in Meters
- CS12 = Multifast Connector, 12-pins
- B1161 = Minifast Connector, 6-pins

LED Options

- (Blank) = No LEDs
- Xn = LEDs, n = Number of LEDs

Junction Box Connectivity Products

Multibox® Eurofast® Low Profile Junction Boxes, 4-Port

- Single Input/Output per Port
- Rugged Plastic Housing
- Available with or without LEDs
- M23 Quick Disconnect or Integral Home Run Cable
- Threaded M12 Connection



Application	Specifications	Pinout		No LEDs	PNP LED	NPN LED		
4-port J-box 1 signal per port, Integral cable	2 A/signal, 9 A total Yellow PVC cable 7/18 AWG foil shield and 20 AWG drain	<u>Function</u> +V -V Ground	<u>Color</u> BN BU GN / YE	<u>Function</u> Port 1 Port 2 Port 3 Port 4	<u>Color</u> WH GN YE GY	4MB12Z-4-*	4MB12Z-4P2-*	4MB12Z-4N2-*
4-port J-box 1 signal per port, Multifast® front connector	2 A/signal, 9 A total 12-pin Multifast connector 7 conductors. Mates with CKCM 12-7-*	<u>Function</u> +V -V Ground	<u>Pin / Color</u> 11/BN 10/BU 12 / GN/YE	<u>Function</u> Port 1 Port 2 Port 3 Port 4	<u>Pin / Color</u> 1 / WH 2 / GN 3 / YE 4 / GY	4MB12Z-4-CS12	4MB12Z-4P2-CS12	4MB12Z-4N2-CS12
4-port J-box 1 signal per port, Multifast side exit connector	2 A/signal, 9 A total 12-pin Multifast connector 7 conductors. Mates with CKCM 12-7-*	<u>Function</u> +V -V Ground	<u>Pin / Color</u> 11/BN 10/BU 12 / GN/YE	<u>Function</u> Port 1 Port 2 Port 3 Port 4	<u>Pin / Color</u> 1 / WH 2 / GN 3 / YE 4 / GY	4MB12Z-4-CS12H	4MB12Z-4P2-CS12H	4MB12Z-4N2-CS12H

* Cable length in meters.

We reserve the right to make technical alterations without prior notice.

Functional Wiring Diagrams

(PNP LED Version)
1 Signal per Port

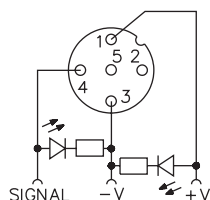

(No LED Version)
1 Signal per Port

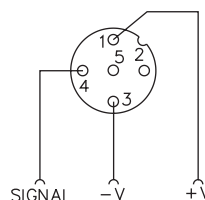

Multibox® Eurofast® Low Profile Junction Boxes, 4-Port

Specifications

Housing:	Nylon	Temperature:	-40 °C to +85 °C (-40 °F to +185 °F)
Connectors:	Eurofast: Nylon or TPU	Protection:	IEC IP68, IP69K
Contacts:	Gold plated brass	Accessories:	(2) VZ 3 closure caps and a VZ 12 label kit (5 labels) included
Thread Inserts:	Nickel plated brass	Cable Length:	Standard length is nominal 5 meters. Other lengths available by request - Consult factory
Cable:	See table		

Dimensions

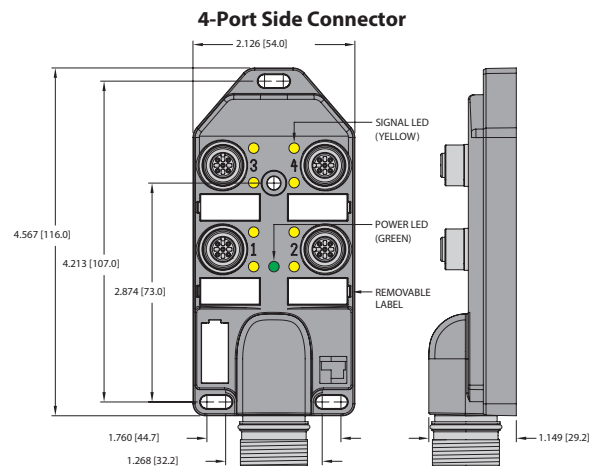
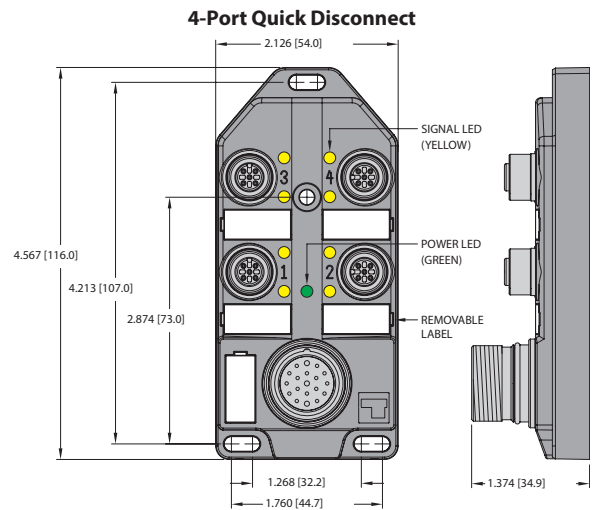
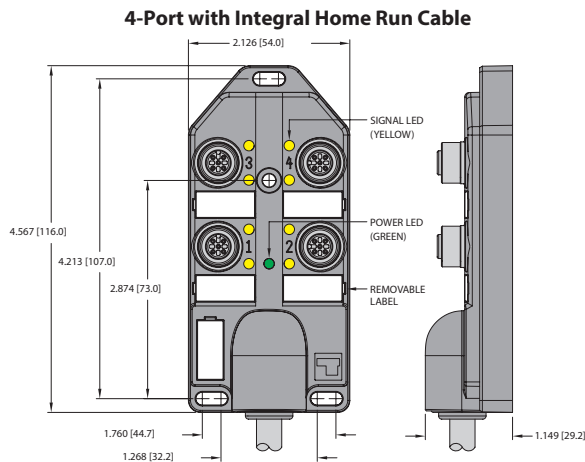

Pinout

5-Pin Eurofast	12-Pin Multifast®
Female	Male

We reserve the right to make technical alterations without prior notice.

multibox®, eurofast®

Junction Box Connectivity Products

Multibox® Eurofast® Low Profile Junction Boxes, 4-Port

- Single Input/Output per Port
- Rugged Plastic Housing
- Available with or without LEDs
- Minifast® Quick Disconnect or Integral Home Run Cable with Minifast Connector
- Threaded M12 Connection



4-Port, 1 Signal per Port, 10-30 VDC

Application	Specifications	Pinout				No LEDs	PNP LED	NPN LED
4-port J-box 1 signal per port, integral cable with Minifast connector	2 A/signal 7 A total 12-pin Minifast connector 7 conductors. Mates with RKM 126-*M	<u>Function</u> +V - V Ground	<u>Pin / Color</u> 10 / RD 11 / WH 9 / GN	<u>Function</u> Port 1 Port 2 Port 3 Port 4	<u>Pin / Color</u> 1 / OG 2 / BU 3 / WH/BK 4 / RD/BK	4MB12Z-4-*-RSM 120	4MB12Z-4P2-*-RSM 120	4MB12Z-4N2-*-RSM 120
4-port J-box 1 signal per port, Minifast connector	2 A/signal 7 A total 12-pin Minifast connector 7 conductors. Mates with RKM 126-*M	<u>Function</u> +V - V Ground	<u>Pin / Color</u> 10 / RD 11 / WH 9 / GN	<u>Function</u> Port 1 Port 2 Port 3 Port 4	<u>Pin / Color</u> 1 / OG 2 / BU 3 / WH/BK 4 / RD/BK	4MB12Z-4-RSF120	4MB12Z-4P2-RSF120	-----

* Cable length in meters.

We reserve the right to make technical alterations without prior notice.

Functional Wiring Diagrams

(PNP LED Version)
1 Signal per Port

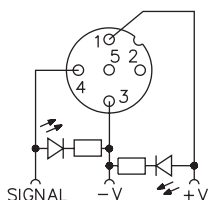

(No LED Version)
1 Signal per Port

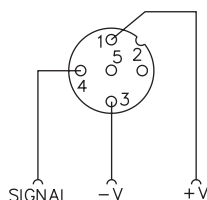

Multibox® Eurofast® Low Profile Junction Boxes, 4-Port

Specifications

Housing:	Nylon	Temperature:	-40 °C to +85 °C (-40 °F to +185 °F)
Connectors:	Eurofast: Nylon or TPU	Protection:	IEC IP68, IP69K
Contacts:	Gold plated brass	Accessories:	(2) VZ 3 closure caps and a VZ 12 label kit (5 labels) included
Thread Inserts:	Nickel plated brass	Cable Length:	Standard length is nominal 5 meters. Other lengths available by request - Consult factory
Cable:	See table		

Dimensions

4-Port, Integral Home Run with Minifast® Connector

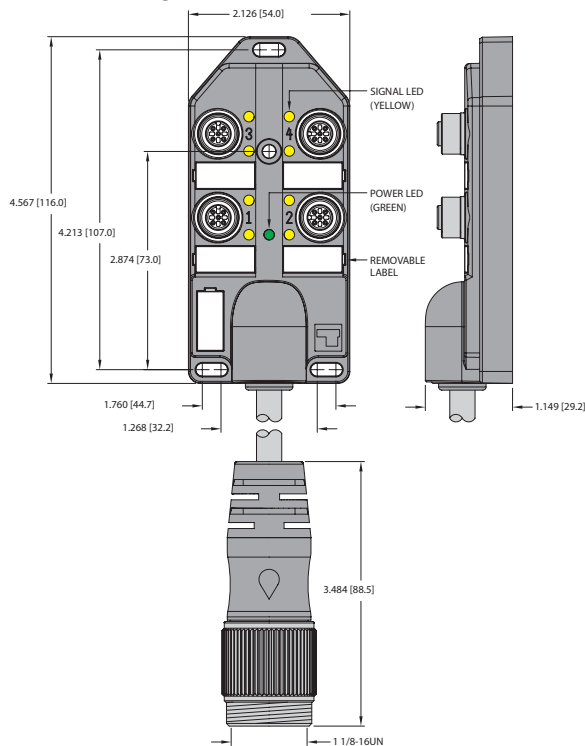

4-Port, Minifast Quick Disconnect

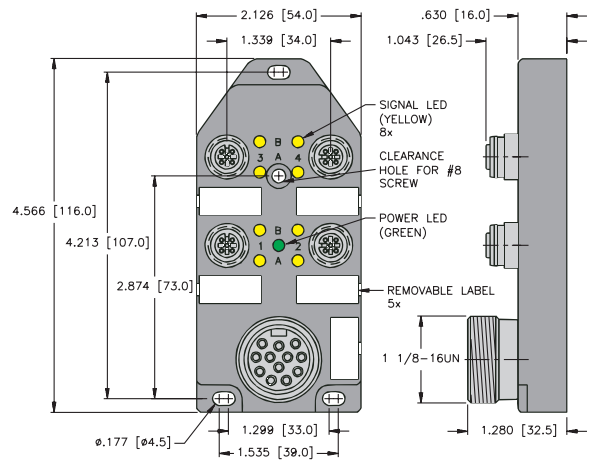

We reserve the right to make technical alterations without prior notice.

multibox®, eurofast®

Pinout

5-Pin Eurofast	12-Pin Minifast
Female	Male

Junction Box Connectivity Products

Multibox® Eurofast® Low Profile Junction Boxes, 4-Port

- Dual Input/Output per Port
- Rugged Plastic Housing
- Available with or without LEDs
- M23 Quick Disconnect or Integral Home Run Cable
- Threaded M12 Connection



4-Port, 2 Signals per Port, 10-30 VDC

Application	Specifications	Pinout				No LEDs	PNP LED	NPN LED
4-port J-box 2 signals per port Integral cable	2 A/signal 9 A total Yellow PVC cable 3/18 AWG, 8/22 AWG foil shield and 20 AWG drain	<u>Function</u> +V -V Ground Port 1, Sig 1 Port 1, Sig 2	<u>Color</u> BN BU GN / YE WH GY / PK	<u>Function</u> Port 2, Sig 1 Port 2, Sig 2 Port 3, Sig 1 Port 3, Sig 2 Port 4, Sig 1 Port 4, Sig 2	<u>Color</u> GN RD / BU YE WH / GN GY BN / GN	4MB12Z-5-*	4MB12Z-5P3-*	4MB12Z-5N3-*
4-port J-box 2 signals per port Multifast® connector	2 A/signal 9 A total 19-pin Multifast connector 11 conductors. Mates with CKM 19-11-*	<u>Function</u> +V -V Ground Port 1, Sig 1 Port 1, Sig 2	<u>Color</u> 19 / BN 6 / BU 12 / GN / YE 15 / WH 7 / GY / PK	<u>Function</u> Port 2, Sig 1 Port 2, Sig 2 Port 3, Sig 1 Port 3, Sig 2 Port 4, Sig 1 Port 4, Sig 2	<u>Color</u> 5 / GN 4 / RD / BU 16 / YE 8 / WH / GN 3 / GY 14 / BN / GN	4MB12Z-5-CS19	4MB12Z-5P3-CS19	4MB12Z-5N3-CS19
4-port J-box 2 signals per port Multifast, side exit connector	2 A/signal 9 A total 19-pin Multifast connector 11 conductors. Mates with CKM 19-11-*	<u>Function</u> +V -V Ground Port 1, Sig 1 Port 1, Sig 2	<u>Color</u> 19 / Bn 6 / Bu 12 / GN / YE 15 / WH 7 / Gy / Pk	<u>Function</u> Port 2, Sig 1 Port 2, Sig 2 Port 3, Sig 1 Port 3, Sig 2 Port 4, Sig 1 Port 4, Sig 2	<u>Color</u> 5 / GN 4 / Rd / Bu 16 / YE 8 / WH / GN 3 / Gy 14 / Bn / Gn	4MB12Z-5-CS19H	4MB12Z-5P3-CS19H	4MB12Z-5N3-CS19H

We reserve the right to make technical alterations without prior notice.

Functional Wiring Diagrams

(PNP LED Version)
2 Signals per Port

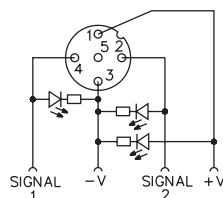

(No LED Version)
2 Signals per Port

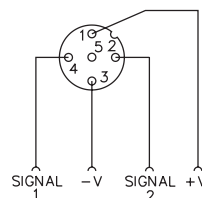

Multibox® Eurofast® Low Profile Junction Boxes, 4-Port

Specifications

Housing:	Nylon	Temperature:	-40 °C to +85 °C (-40 °F to +185 °F)
Connectors:	Eurofast: Nylon or TPU	Protection:	IEC IP68, IP69K
Contacts:	Gold plated brass	Accessories:	(2) VZ 3 closure caps and a VZ 12 label kit (5 labels) included
Thread Inserts:	Nickel plated brass	Cable Length:	Standard length is nominal 5 meters. Other lengths available by request - Consult factory
Cable:	See table		
Recommended Splitter:	YB2-FSM 4.5-2 FKM 4.5		

Dimensions

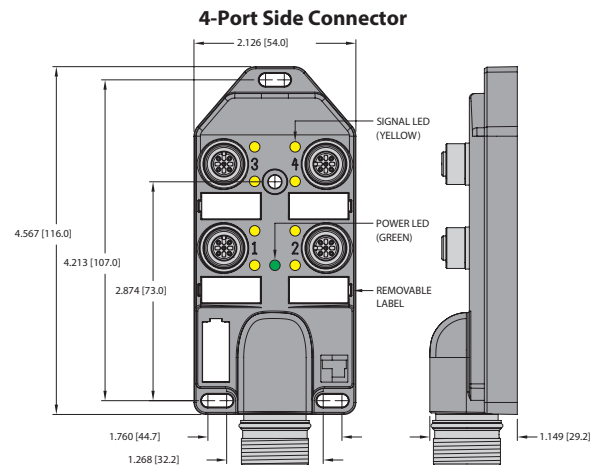
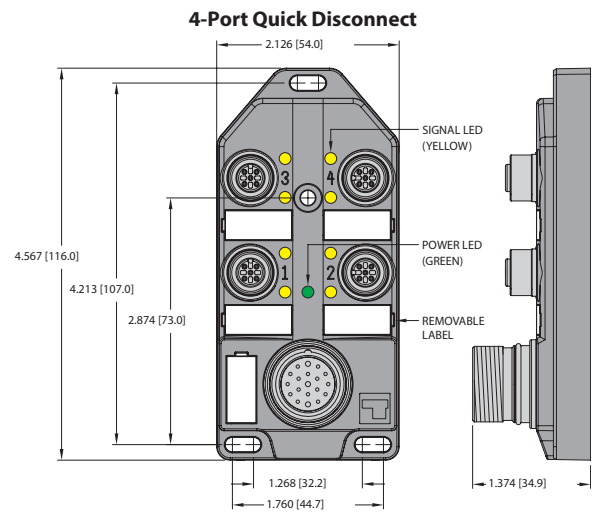
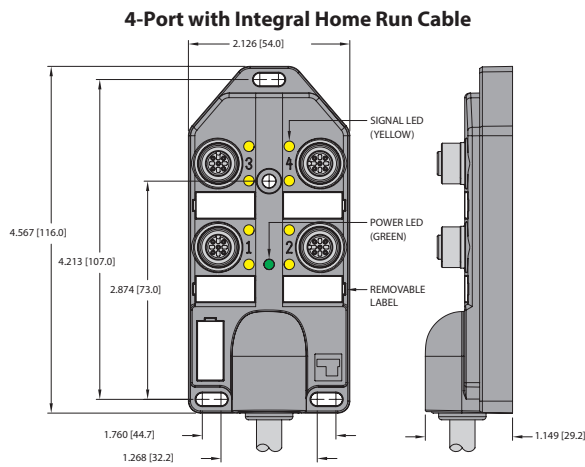

Pinout

5-Pin Eurofast	19-Pin Multifast®
Female	Male

We reserve the right to make technical alterations without prior notice.

multibox®, eurofast®

Junction Box Connectivity Products

Multibox® Eurofast® Low Profile Junction Boxes, 6-Port

- Single Input/ Output per Port
- Rugged Plastic Housing
- Available with or without LEDs
- M23 Quick Disconnect or Integral Home Run Cable
- Threaded M12 Connection



6-Port, 1 Signal per Port, 10-30 VDC

Application	Specifications	Pinout				No LEDs	PNP LED	NPN LED
6-port J-box 1 signal per port, Integral cable	2 A/signal 9 A total Yellow PVC cable 9/18 AWG foil shield and 20 AWG drain	<u>Function</u>	<u>Color</u>	<u>Function</u>	<u>Color</u>	6MB12Z-4*	6MB12Z-4P2.*	6MB12Z-4N2.*
		+V	BN	Port 1	WH			
-V	BU	Port 2	GN					
Ground	GN / YE	Port 3	YE					
		Port 4	GY					
		Port 5	PK					
		Port 6	RD					
6-port J-box 1 signal per port, Multifast® connector	2 A/signal 9 A total 12-pin Multifast connector 9 conductors. Mates with CKCM 12-9.*	<u>Function</u>	<u>Pin / Color</u>	<u>Function</u>	<u>Pin / Color</u>	6MB12Z-4-CS12	6MB12Z-4P2-CS12	6MB12Z-4N2-CS12
		+V	11 / BN	Port 1	1 / WH			
-V	10 / BU	Port 2	2 / GN					
Ground	12 / GN / YE	Port 3	3 / YE					
		Port 4	4 / GY					
		Port 5	5 / PK					
		Port 6	6 / RD					
6-port J-box 1 signal per port, Multifast side exit connector	2 A/signal 9 A total 12-pin Multifast connector 9 conductors. Mates with CKCM 12-9.*	<u>Function</u>	<u>Pin / Color</u>	<u>Function</u>	<u>Pin / Color</u>	6MB12Z-4-CS12H	6MB12Z-4P2-CS12H	6MB12Z-4N2-CS12H
		+V	11 / BN	Port 1	1 / WH			
-V	10 / BU	Port 2	2 / GN					
Ground	12 / GN / YE	Port 3	3 / YE					
		Port 4	4 / GY					
		Port 5	5 / PK					
		Port 6	6 / RD					

* Cable length in meters.

We reserve the right to make technical alterations without prior notice.

Functional Wiring Diagrams

(PNP LED Version)
1 Signal per Port

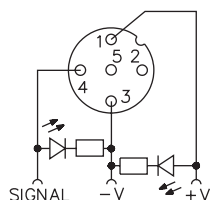

(No LED Version)
1 Signal per Port

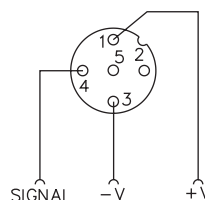

Multibox® Eurofast® Low Profile Junction Boxes, 6-Port

Specifications

Housing:	Nylon	Temperature:	-40 °C to +85 °C (-40 °F to +185 °F)
Connectors:	Eurofast: Nylon or TPU	Protection:	IEC IP68, IP69K
Contacts:	Gold plated brass	Accessories:	(2) VZ 3 closure caps and a VZ 12 label kit (7 labels) included
Thread Inserts:	Nickel plated brass	Cable Length:	Standard length is nominal 5 meters. Other lengths available by request - Consult factory
Cable:	See table		

Dimensions

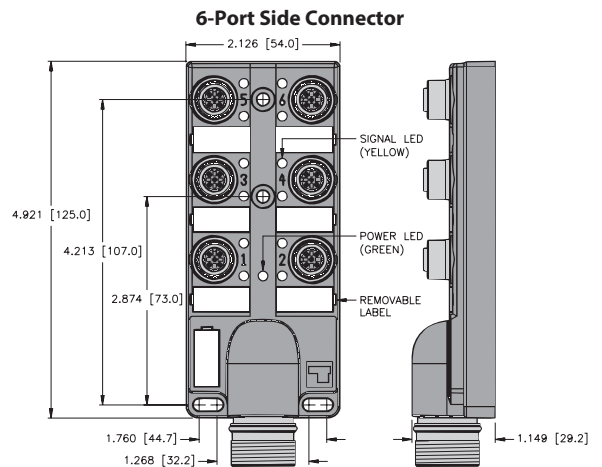
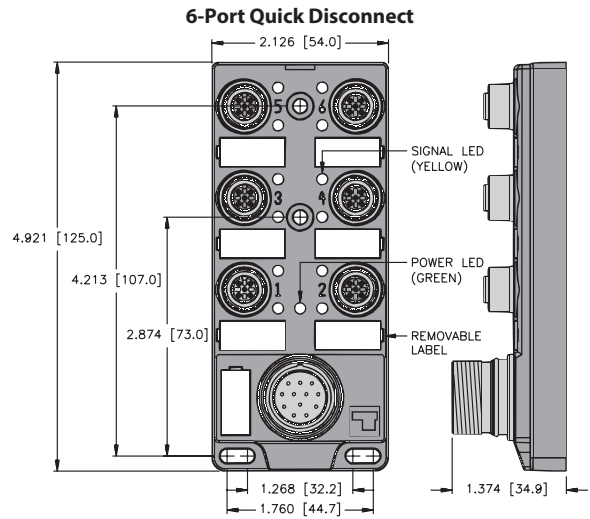
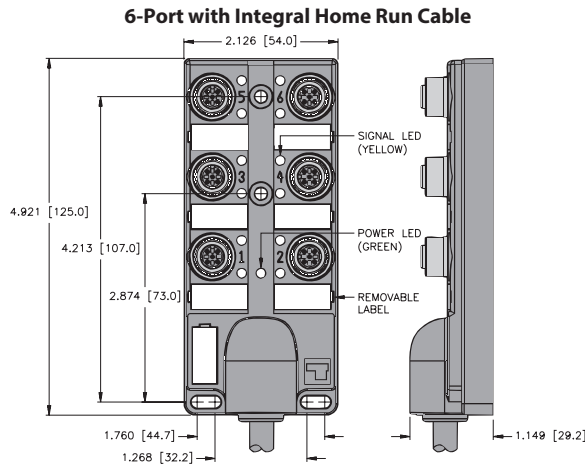

Pinout

5-Pin Eurofast	12-Pin Multifast®
Female	Male

We reserve the right to make technical alterations without prior notice.

multibox®, eurofast®

Junction Box Connectivity Products

Multibox® Eurofast® Low Profile Junction Boxes, 6-Port

- Dual Input/Output per Port
- Rugged Plastic Housing
- Available with or without LEDs
- M23 Quick Disconnect or Integral Home Run Cable
- Threaded M12 Connection



6-Port, 2 Signals per Port, 10-30 VDC

Application	Specifications	Pinout				No LEDs	PNP LED	NPN LED
6-port J-box 2 signals per port Integral cable	2 A/signal 9 A total Yellow PVC cable 3/18 AWG, 12/22 AWG foil shield and 22 AWG drain	<u>Function</u>	<u>Color</u>	<u>Function</u>	<u>Color</u>	6MB12Z-5*	6MB12Z-5P3*	6MB12Z-5N3*
		+V	BN	Port 3, Sig 1	YE			
		-V	BU	Port 3, Sig 2	WH / GN			
		Ground	GN / YE	Port 4, Sig 1	GY			
		Port 1, Sig 1	WH	Port 4, Sig 2	BN / GN			
		Port 1, Sig 2	GY / PK	Port 5, Sig 1	PK			
		Port 2, Sig 1	GN	Port 5, Sig 2	WH/YE			
		Port 2, Sig 2	RD / BU	Port 6, Sig 1	RD			
				Port 6, Sig 2	YE/BN			
6-port J-box 2 signals per port Multifast® connector	2 A/signal 9 A total 19-pin Multifast connector 15 conductors. Mates with CKM 19-15*	<u>Function</u>	<u>Pin / Color</u>	<u>Function</u>	<u>Pin / Color</u>	6MB12Z-5-CS19	6MB12Z-5P3-CS19	6MB12Z-5N3-CS19
		+V	19 / BN	Port 3, Sig 1	16 / YE			
		-V	6 / BU	Port 3, Sig 2	8 / WH / GN			
		Ground	12 / GN / YE	Port 4, Sig 1	3 / GY			
		Port 1, Sig 1	15 / WH	Port 4, Sig 2	14 / BN / GN			
		Port 1, Sig 2	7 / GY / PK	Port 5, Sig 1	17 / PK			
		Port 2, Sig 1	5 / GN	Port 5, Sig 2	9 / WH/YE			
		Port 2, Sig 2	4 / RD / BU	Port 6, Sig 1	2 / RD			
				Port 6, Sig 2	13 / YE/BN			
6-port J-box 2 signals per port Multifast, side exit connector	2 A/signal 9 A total 19-pin Multifast connector 15 conductors. Mates with CKM 19-15*	<u>Function</u>	<u>Pin / Color</u>	<u>Function</u>	<u>Pin / Color</u>	6MB12Z-5-CS19H	6MB12Z-5P3-CS19H	6MB12Z-5N3-CS19H
		+V	19 / BN	Port 3, Sig 1	16 / YE			
		-V	6 / BU	Port 3, Sig 2	8 / WH / GN			
		Ground	12 / GN / YE	Port 4, Sig 1	3 / GY			
		Port 1, Sig 1	15 / WH	Port 4, Sig 2	14 / BN / GN			
		Port 1, Sig 2	7 / GY / PK	Port 5, Sig 1	17 / PK			
		Port 2, Sig 1	5 / GN	Port 5, Sig 2	9 / WH/YE			
		Port 2, Sig 2	4 / RD/BU	Port 6, Sig 1	2 / RD			
				Port 6, Sig 2	13 / YE/BN			

We reserve the right to make technical alterations without prior notice.

Functional Wiring Diagrams

**(PNP LED Version)
2 Signals per Port**

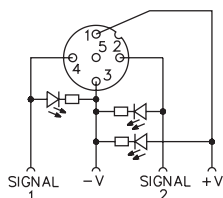

**(No LED Version)
2 Signals per Port**

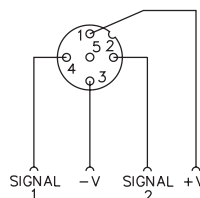

Specifications

Housing:	Nylon	Temperature:	-40 °C to +85 °C (-40 °F to +185 °F)
Connectors:	Eurofast: Nylon or TPU	Protection:	IEC IP68, IP69K
Contacts:	Gold plated brass	Accessories:	(2) VZ 3 closure caps and a VZ 12 label kit (7 labels) included
Thread Inserts:	Nickel plated brass	Cable Length:	Standard length is nominal 5 meters. Other lengths available by request - Consult factory
Cable:	See table		
Recommended Splitter:	YB2-FSM 4.5-2 FKM 4.5		

Dimensions

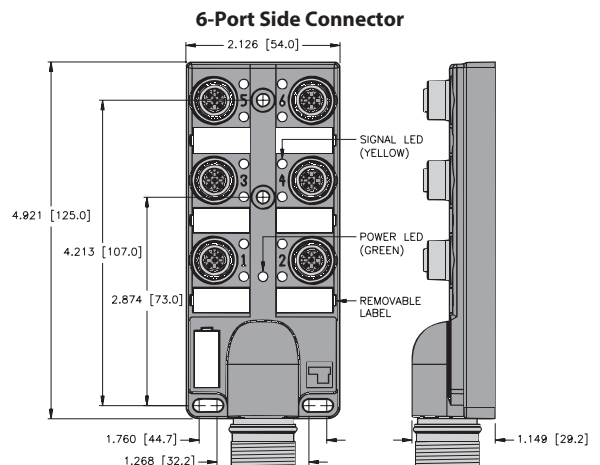
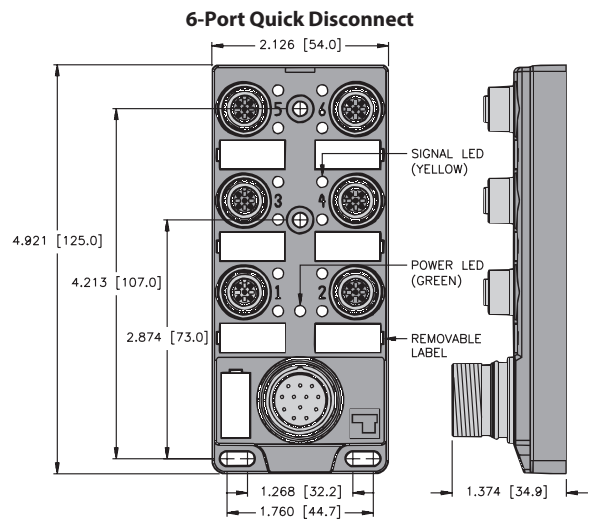
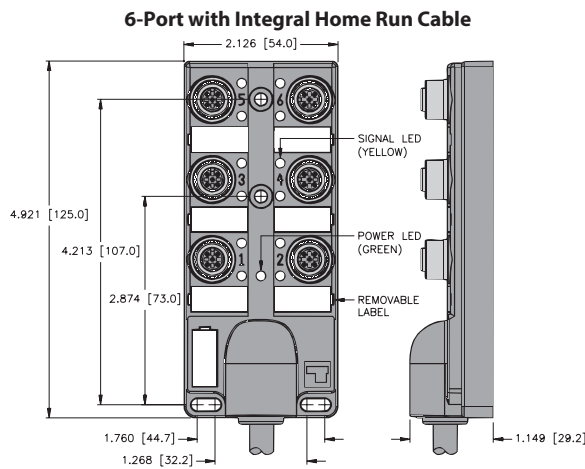

Pinout

5-Pin Eurofast	19-Pin Multifast®
Female	Male

We reserve the right to make technical alterations without prior notice.

multibox®, eurofast®

Junction Box Connectivity Products

Multibox® Eurofast® Low Profile Junction Boxes, 8-Port

- Single Input/Output per Port
- Rugged Plastic Housing
- Available with or without LEDs
- M23 Quick Disconnect or Integral Home Run Cable
- Threaded M12 Connection



8-Port, 1 Signal per Port, 10-30 VDC

Application	Specifications	Pinout		No LEDs	PNP LED	NPN LED		
8-port J-box 1 signal per port Integral cable	2 A/signal, 9 A total Yellow PVC cable 11/18 AWG, foil shield and 20 AWG drain with PUR cable, add /S90	<u>Function</u> +V -V Ground Port 1 Port 2 Port 3	<u>Color</u> BN BU GN / YE WH GN YE	<u>Function</u> Port 4 Port 5 Port 6 Port 7 Port 8	<u>Color</u> GY PK RD BK VT	8MB12Z-4-*	8MB12Z-4P2-*	8MB12Z-4N2-*
8-port J-box 1 signal per port Multifast® connector	2 A/signal, 9 A total 12-pin Multifast connector 11 conductors. Mates with CKCM 12-11-*	<u>Function</u> +V -V Ground Port 1 Port 2 Port 3	<u>Pin / Color</u> 11 / BN 10 / BU 12 / GN / YE 1 / WH 2 / GN 3 / YE	<u>Function</u> Port 4 Port 5 Port 6 Port 7 Port 8	<u>Pin / Color</u> 4 / GY 5 / PK 6 / RD 7 / BK 8 / VT	8MB12Z-4-CS12	8MB12Z-4P2-CS12	8MB12Z-4N2-CS12
8-port J-box 1 signal per port Multifast, side exit connector	2 A/signal, 9 A total 12-pin Multifast connector 11 conductors. Mates with CKCM 12-11-*	<u>Function</u> +V -V Ground Port 1 Port 2 Port 3	<u>Pin / Color</u> 11 / BN 10 / BU 12 / GN / YE 1 / WH 2 / GN 3 / YE	<u>Function</u> Port 4 Port 5 Port 6 Port 7 Port 8	<u>Pin / Color</u> 4 / GY 5 / PK 6 / RD 7 / BK 8 / VT	8MB12Z-4-CS12H	8MB12Z-4P2-CS12H	8MB12Z-4N2-CS12H

* Cable length in meters.

We reserve the right to make technical alterations without prior notice.

Functional Wiring Diagrams

(PNP LED Version)
1 Signal per Port

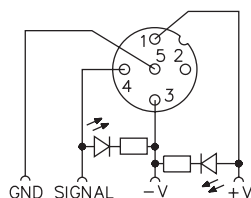

(No LED Version)
1 Signal per Port

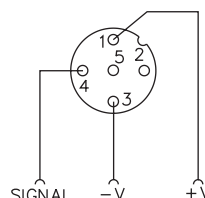

Multibox® Eurofast® Low Profile Junction Boxes, 8-Port

Specifications

Housing:	Nylon	Temperature:	-40 °C to +85 °C (-40 °F to +185 °F)
Connectors:	Eurofast: Nylon or TPU	Protection:	IEC IP68, IP69K
Contacts:	Gold plated brass	Accessories:	(2) VZ 3 closure caps and a VZ 12 label kit (9 labels), included
Thread Inserts:	Nickel plated brass	Cable Length:	Standard length is nominal 5 meters. Other lengths available by request - Consult factory
Cable:	See table		

Dimensions

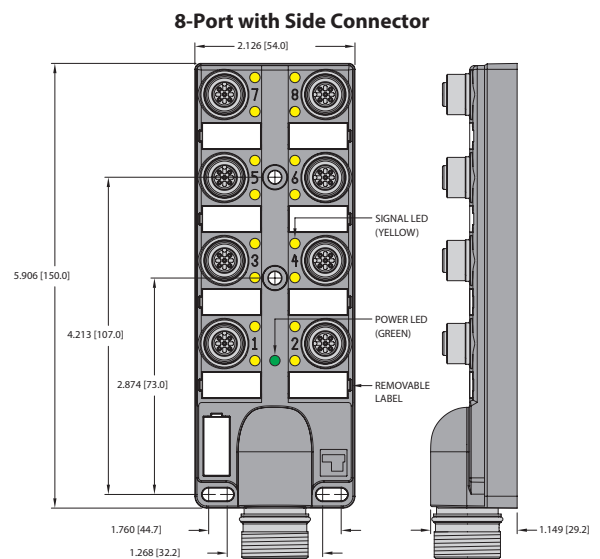
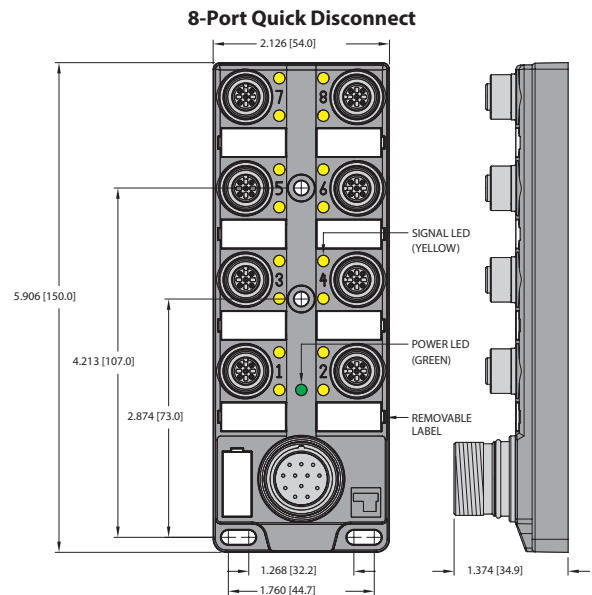
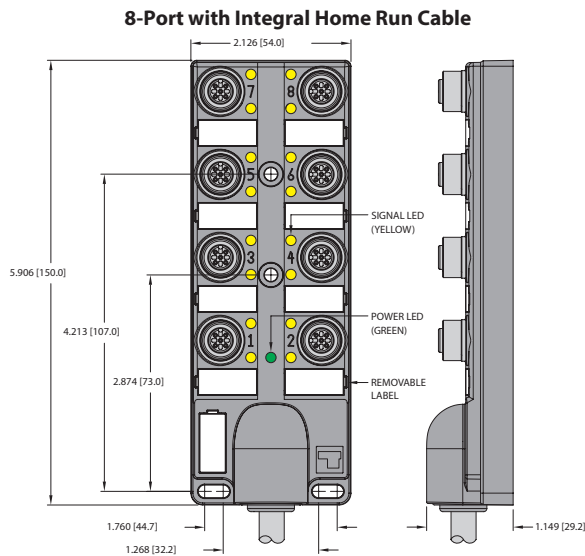

Pinout

5-Pin Eurofast	12-pin Multifast®
Female	Male

We reserve the right to make technical alterations without prior notice.

multibox®, eurofast®

Junction Box Connectivity Products

Multibox® Eurofast® Low Profile Junction Boxes, 8-Port

- Single Input/Output per Port
- Rugged Plastic Housing
- Available with or without LEDs
- Minifast® Quick Disconnect or Integral Home Run Cable with Minifast Connector
- Threaded M12 Connection



8-Port, 1 Signal per Port, 10-30 VDC

Application	Specifications	Pinout				No LEDs	PNP LED	NPN LED
8-port J-box 1 signal per port Minifast connector	2 A/signal	<u>Function</u>	<u>Pin / Color</u>	<u>Function</u>	<u>Pin / Color</u>	8MB12Z-4-*-RSM120	8MB12Z-4P2-*-RSM120	8MB12Z-4N2-*-RSM120
	7 A total	+V	10 / RD	Port 4	4 / RD/BK			
12-pin Minifast connector	11 conductors. Mates with RKM 126-*M	-V	11 / WH	Port 5	5 / GN/BK	8MB12Z-4-RSF120	8MB12Z-4P2-RSF120	8MB12Z-4N2-RSF120
		Ground	9 / GN	Port 6	6 / OG/BK			
		Port 1	1 / OG	Port 7	7 / BU/BK			
		Port 2	2 / BU	Port 8	8 / BK/WH			
		Port 3	3 / WH/BK					

* Cable length in meters.

We reserve the right to make technical alterations without prior notice.

Functional Wiring Diagrams

(PNP LED Version)
1 Signal per Port

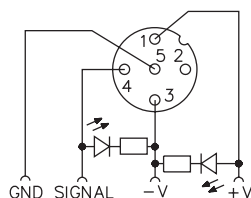

(No LED Version)
1 Signal per Port

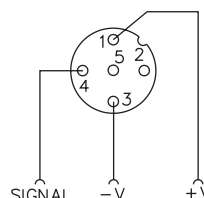

Multibox® Eurofast® Low Profile Junction Boxes, 8-Port

Specifications

Housing:	Nylon	Temperature:	-40 °C to +85 °C (-40 °F to +185 °F)
Connectors:	Eurofast: Nylon or TPU	Protection:	IEC IP68, IP69K
Contacts:	Gold plated brass	Accessories:	(2) VZ 3 closure caps and a VZ 1 label kit (8 labels), included
Thread Inserts:	Nickel plated brass	Cable Length:	Standard length is nominal 5 meters. Other lengths available by request - Consult factory
Cable:	See table		

Dimensions

8-Port Integral Home Run with Minifast® Connector

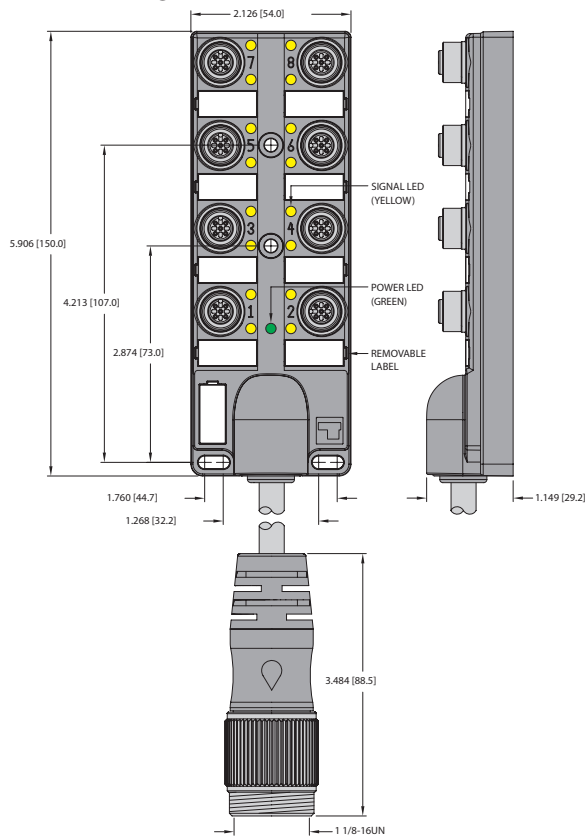

8-Port Minifast Quick Disconnect

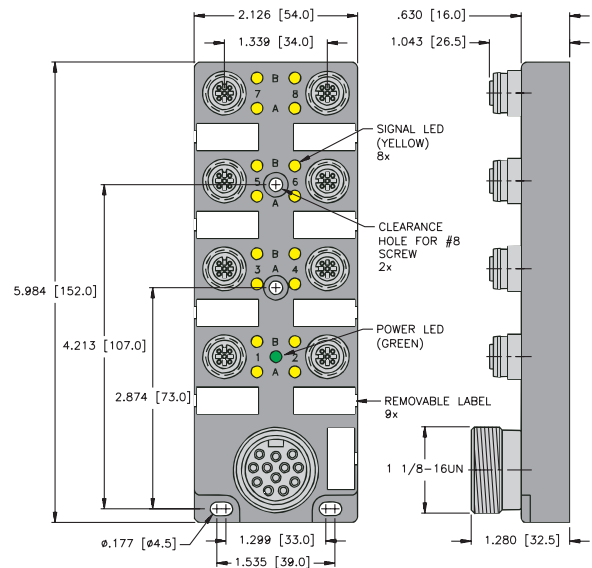

We reserve the right to make technical alterations without prior notice.

multibox®, eurofast®

Pinout

5-Pin Eurofast	12-pin Minifast
Female	Male

Junction Box Connectivity Products

Multibox® Eurofast® Low Profile Junction Boxes 8-Port

- Dual Input/Output per Port
- Rugged Plastic Housing
- Available with or without LEDs
- M23 Quick Disconnect or Integral Home Run Cable
- Threaded M12 Connection



8-Port, 2 Signals per Port, 10-30 VDC

Application	Specifications	Pinout				No LEDs	PNP LED	NPN LED
8-port J-box 2 signals per port Integral cable	2 A/signal 9 A total Yellow PVC cable 3x18 AWG, Integral 16x22 AWG, foil shield and 20 AWG drain	<u>Function</u>	<u>Color</u>	<u>Function</u>	<u>Color</u>	8MB12Z-5-*	8MB12Z-5P3-*	8MB12Z-5N3-*
		+V	BN	Port 4, Sig 1	GY			
-V	BU	Port 4, Sig 2	BN / GN					
Ground	GN / YE	Port 5, Sig 1	PK					
Port 1, Sig 1	WH	Port 5, Sig 2	WH / YE					
Port 1, Sig 2	GY / PK	Port 6, Sig 1	RD					
Port 2, Sig 1	GN	Port 6, Sig 2	YE / BN					
Port 2, Sig 2	RD / BU	Port 7, Sig 1	BK					
Port 3, Sig 1	YE	Port 7, Sig 2	WH / GY					
Port 3, Sig 2	WH / GN	Port 8, Sig 1	VT					
		Port 8, Sig 2	GY / BN					
8-port J-box 2 signals per port Multifast® connector	2 A/signal 9 A total 19-pin Multifast connector 19 conductors. Mates with CKM 19-19-*	<u>Function</u>	<u>Color</u>	<u>Function</u>	<u>Color</u>	8MB12Z-5-CS19	8MB12Z-5P3-CS19	8MB12Z-5N3-CS19
		+V	19 / BN	Port 4, Sig 1	3 / GY			
		-V	6 / BU	Port 4, Sig 2	14 / BN / GN			
		Ground	12 / GN / YE	Port 5, Sig 1	17 / PK			
		Port 1, Sig 1	15 / WH	Port 5, Sig 2	9 / WH / YE			
		Port 1, Sig 2	7 / GY / PK	Port 6, Sig 1	2 / RD			
		Port 2, Sig 1	5 / GN	Port 6, Sig 2	13 / YE / BN			
		Port 2, Sig 2	4 / RD / BU	Port 7, Sig 1	11 / BK			
		Port 3, Sig 1	16 / YE	Port 7, Sig 2	10 / WH / GY			
		Port 3, Sig 2	8 / WH / GN	Port 8, Sig 1	1 / VT			
		Port 8, Sig 2	18 / GY / BN					
8-port J-box 2 signals per port Multifast, side exit connector	2 A/signal 9 A total 19-pin Multifast connector 19 conductors. Mates with CKM 19-19-*	<u>Function</u>	<u>Color</u>	<u>Function</u>	<u>Color</u>	8MB12Z-5-CS19H	8MB12Z-5P3-CS19H	8MB12Z-5N3-CS19H
		+V	19 / BN	Port 4, Sig 1	3 / GY			
		-V	6 / BU	Port 4, Sig 2	14 / BN / GN			
		Ground	12 / GN / YE	Port 5, Sig 1	17 / PK			
		Port 1, Sig 1	15 / WH	Port 5, Sig 2	9 / WH / YE			
		Port 1, Sig 2	7 / GY / PK	Port 6, Sig 1	2 / RD			
		Port 2, Sig 1	5 / GN	Port 6, Sig 2	13 / YE / BN			
		Port 2, Sig 2	4 / RD / BU	Port 7, Sig 1	11 / BK			
		Port 3, Sig 1	16 / YE	Port 7, Sig 2	10 / WH / GY			
		Port 3, Sig 2	8 / WH / GN	Port 8, Sig 1	1 / VT			
		Port 8, Sig 2	18 / GY / BN					

We reserve the right to make technical alterations without prior notice.

* Cable length in meters.

Functional Wiring Diagrams

(PNP LED Version)
2 Signals per Port

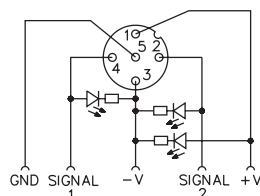

(No LED Version)
2 Signals per Port

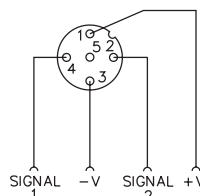

Multibox® Eurofast® Low Profile Junction Boxes 8-Port

Specifications

Housing:	Nylon	Temperature:	-40 °C to +85 °C (-40 °F to +185 °F)
Connectors:	Eurofast: Nylon or TPU	Protection:	IEC IP68, IP69K
Contacts:	Gold plated brass	Accessories:	(2) VZ 3 closure caps and a VZ 12 label kit (9 labels), included
Thread Inserts:	Nickel plated brass	Cable Length:	Standard length is nominal 5 meters. Other lengths available by request - Consult factory
Cable:	See table		
Recommended Splitter:	YB2-FSM 4.5-2FKM 4.5		

Dimensions

8-Port with Integral Home Run Cable

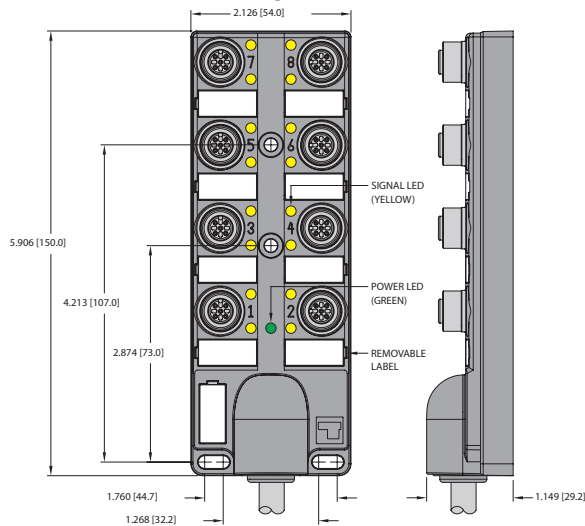

8-Port Quick Disconnect

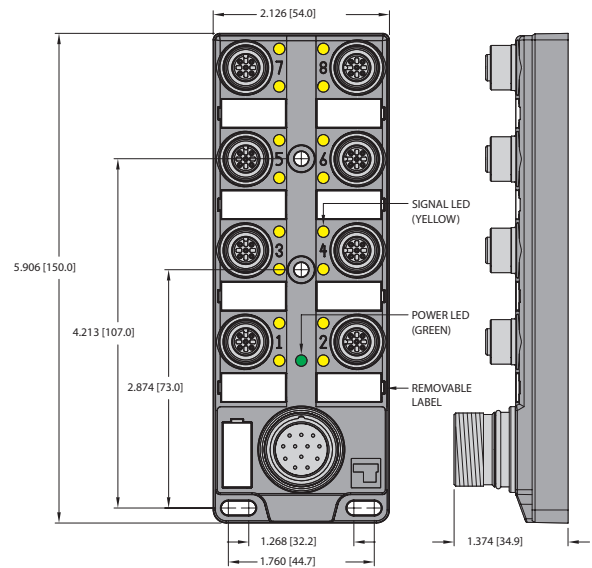

8-Port Side Connector

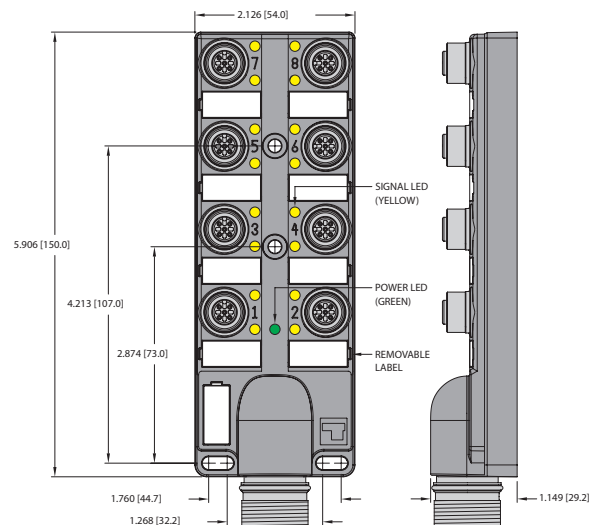

Pinout

5-Pin Eurofast	19-Pin Multifast®
Female	Male

We reserve the right to make technical alterations without prior notice.

multibox®, eurofast®

Junction Box Connectivity Products

Multibox® Eurofast®, Junction Boxes, 4-Port Stainless Steel Connector Options

- 1 or 2 Signals per Port
- Rugged Plastic Housing with Flush Connectors
- Available with LEDs
- M23 Quick Disconnect or Integral Home Run Cable
- Available with Stainless Steel Threaded Connections



4-Port, 1 Signal per Port, 10-48 VDC

Application	Specifications	Pinout				Part Number
4-port J-box 1 signal per port Integral cable	4 A/port, 9 A total Yellow PVC cable** 7x18 AWG foil shield and 20 AWG drain **with PUR cable, add /S90	<u>Function</u> +V -V Ground	<u>Color</u> BN BU GN / YE	<u>Function</u> Port 1 Port 2 Port 3 Port 4	<u>Color</u> WH GN YE GY	4MBV12-4P2-*
4-port J-box 1 signal per port Multifast® connector	4 A/port, 8 A total 12-pin Multifast connector 7 conductors. Mates with CKCMV12-7-*	<u>Function</u> +V -V Ground	<u>Pin / Color</u> 11 / BN 10 / BU 12 / GN / YE	<u>Function</u> Port 1 Port 2 Port 3 Port 4	<u>Pin / Color</u> 1 / WH 2 / GN 3 / YE 4 / GY	4MBV12-4P2-CSV12

4-Port, 2 Signal per Port, 10-48 VDC

Application	Specifications	Pinout				Part Number
4-port J-box 2 signals per port Integral cable	4 A/port, 9 A total Yellow PVC cable** 3x18 AWG, 8x22 AWG foil shield and 20 AWG drain **with PUR cable, add /S90	<u>Function</u> +V -V Ground port 1, Sig 1 port 1, Sig 2	<u>Color</u> BN BU GN/YE WH GY / PK	<u>Function</u> port 2, Sig 1 port 2, Sig 2 port 3, Sig 1 port 3, Sig 2 port 4, Sig 1 port 4, Sig 2	<u>Color</u> GN RD / BU YE WH / GN GY BN / GN	4MBV12-5P3-*
4-port J-box 2 signals per port Multifast connector	4 A/port, 8 A total 19-pin Multifast connector 11 conductors. Mates with CKMV 19-11-*	<u>Function</u> +V -V Ground Port 1, Sig 1 Port 1, Sig 2	<u>Pin / Color</u> 19 / BN 6 / BU 12 / GN/YE 15 / WH 7 / GY/PK	<u>Function</u> Port 2, Sig 1 Port 2, Sig 2 Port 3, Sig 1 Port 3, Sig 2 Port 4, Sig 1 Port 4, Sig 2	<u>Pin / Color</u> 5 / GN 4 / RD / BU 16 / YE 8 / WH / GN 3 / GY 14 / BN / GN	4MBV12-5P3-CSV19

* Cable length in meters.

We reserve the right to make technical alterations without prior notice.

Functional Wiring Diagrams

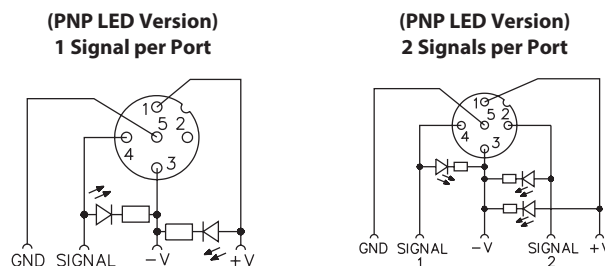

Specifications

Housing:	Nylon	Temperature:	-30 °C to +80 °C (-22 °F to +176 °F)
Connectors:	Eurofast: Nylon or TPU	Protection:	IEC IP67
Contacts:	Gold plated brass	Accessories:	(2) VZ 3 closure caps and a VZ 1 label kit (8 labels) included
Thread Inserts:	Stainless steel	Cable Length:	Standard length is nominal 5 meters. Other lengths available by request - Consult factory
Cable:	See table		
Recommended Splitter:	YB2-FSM 4.5-2 FKM 4.5		

Dimensions

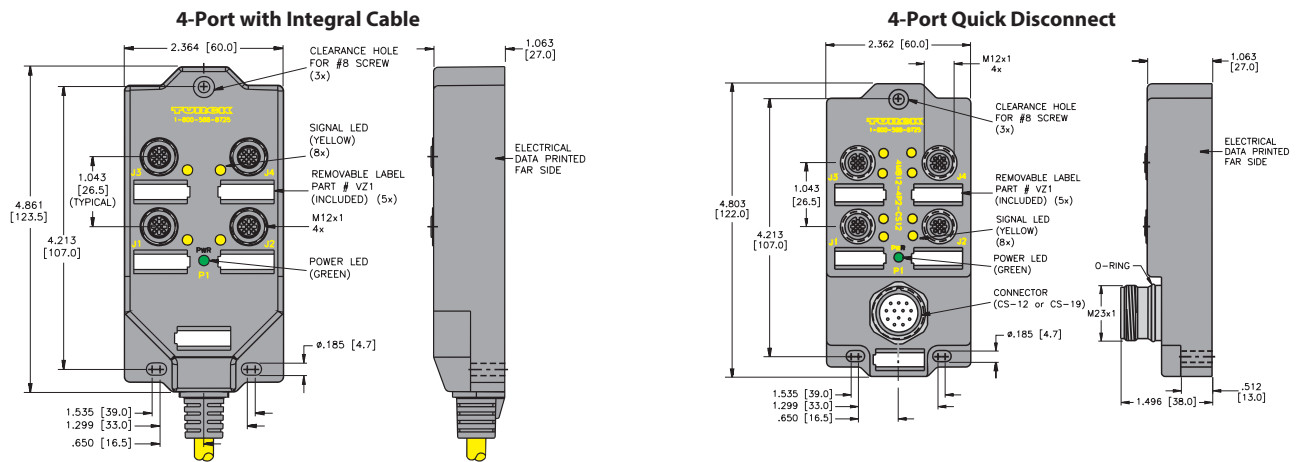

We reserve the right to make technical alterations without prior notice.

multibox®, eurofast®

Pinout

5-Pin Eurofast	12-Pin Multifast®	19-Pin Multifast
Female	Male	Male

Junction Box Connectivity Products

Multibox® Eurofast® 8-Port Junction Boxes, Stainless Steel Connector Options

- 1 or 2 Signals per Port
- Rugged Plastic Housing with Flush Connectors
- Available with LEDs
- M23 Quick Disconnect or Integral Home Run Cable
- Available with Stainless Steel Threaded Connections



8-Port, 1 Signal per Port, 10-48 VDC

Application	Specifications	Pinout				Part Number
8-port J-box 1 signal per port Integral cable	4 A/port, 9 A total Yellow PVC cable** 11x18 AWG, foil shield and 20 AWG drain **with PUR cable, add /S90	<u>Function</u> +V -V Ground Port 1 Port 2 Port 3	<u>Color</u> BN BU GN / YE WH GN YE	<u>Function</u> Port 4 Port 5 Port 6 Port 7 Port 8	<u>Color</u> GY PK RD BK VT	8MBV12-4P2-*
8-port J-box 1 signal per port Multifast® connector	4 A/port, 8 A total 12-pin Multifast connector 11 conductors. Mates with CKCMV 12-11-*	<u>Function</u> +V -V Ground Port 1 Port 2 Port 3	<u>Pin / Color</u> 11 / BN 10 / BU 12 / GN / YE 1 / WH 2 / GN 3 / YE	<u>Function</u> Port 4 Port 5 Port 6 Port 7 Port 8	<u>Pin / Color</u> 4 / GY 5 / PK 6 / RD 7 / BK 8 / VT	8MBV12-4P2-CSV12

8-Port, 2 Signal per Port, 10-48 VDC

Application	Specifications	Pinout				Part Number
8-port J-box 2 signals per port Integral cable	4 A/port, 9 A total Yellow PVC cable** 3x18 AWG, 16x22 AWG, foil shield and 20 AWG drain **with PUR cable, add /S90	<u>Function</u> +V -V Ground Port 1, Sig 1 Port 1, Sig 2 Port 2, Sig 1 Port 2, Sig 2 Port 3, Sig 1 Port 3, Sig 2	<u>Color</u> BN BU GN / YE WH GY / PK GN RD / BU YE WH / GN	<u>Function</u> Port 4, Sig 1 Port 4, Sig 2 Port 5, Sig 1 Port 5, Sig 2 Port 6, Sig 1 Port 6, Sig 2 Port 7, Sig 1 Port 7, Sig 2 Port 8, Sig 1 Port 8, Sig 2	<u>Color</u> GY BN / GN PK WH / YE RD YE / BN BN WH / GY VT GY / BN	8MBV12-5P3-*
8-port J-box 2 signals per port Multifast connector	4 A/port, 8 A total 19-pin Multifast connector 19 conductors. Mates with CKMV 19-19-*	<u>Function</u> +V -V Ground Port 1, Sig 1 Port 1, Sig 2 Port 2, Sig 1 Port 2, Sig 2 Port 3, Sig 1 Port 3, Sig 2	<u>Pin / Color</u> 19 / BN 6 / BU 12 / GN/YE 15 / WH 7 / GY/PK 5 / GN 4 / RD/BU 16 / YE 8 / WH/GN	<u>Function</u> Port 4, Sig 1 Port 4, Sig 2 Port 5, Sig 1 Port 5, Sig 2 Port 6, Sig 1 Port 6, Sig 2 Port 7, Sig 1 Port 7, Sig 2 Port 8, Sig 1 Port 8, Sig 2	<u>Pin / Color</u> 3 / GY 14 / BN / GN 17 / PK 9 / WH / YE 2 / RD 13 / YE / BN 11 / BK 10 / WH / GY 1 / VT 18 / GY / BN	8MBV12-5P3-CSV19

* Cable length in meters.

We reserve the right to make technical alterations without prior notice.

Functional Wiring Diagrams

(PNP LED Version)
1 Signal per Port

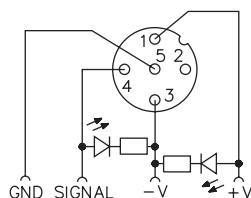

(PNP LED Version)
2 Signals per Port

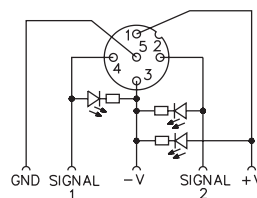

Specifications

Housing:	Nylon	Temperature:	-30 °C to +80 °C (-22 °F to +176 °F)
Connectors:	Eurofast: Nylon or TPU	Protection:	IEC IP67
Contacts:	Gold plated brass	Accessories:	(2) VZ 3 closure caps and a VZ 1 label kit (8 labels), included
Thread Inserts:	Stainless steel	Cable Length:	Standard length is nominal 5 meters. Other lengths available by request - Consult factory
Cable:	See table		
Recommended Splitter:	YB2-FSM 4.5-2 FKM 4.5		

Dimensions

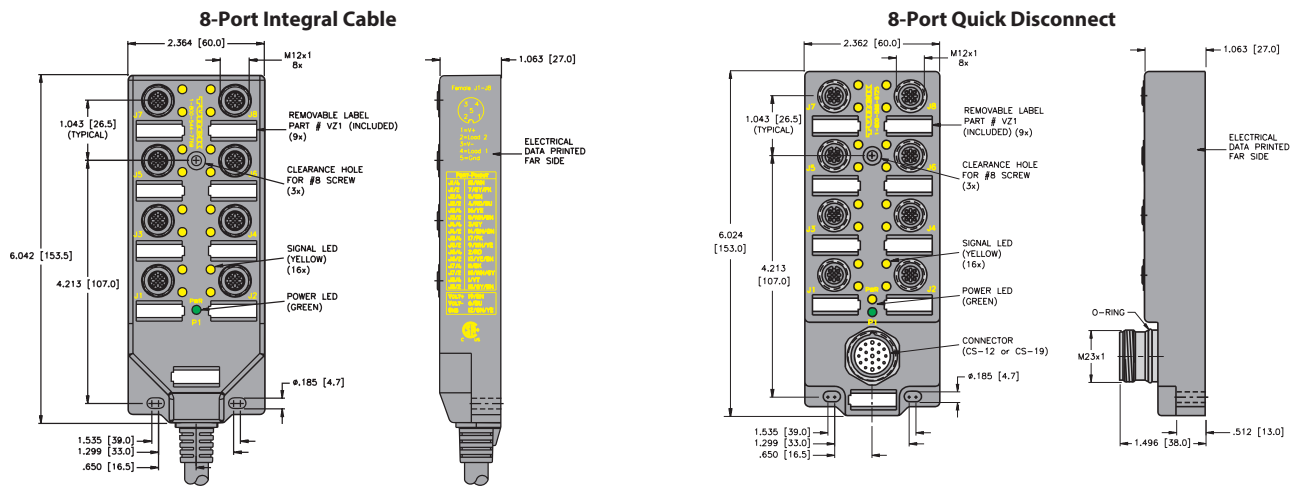

We reserve the right to make technical alterations without prior notice.

multibox®, eurofast®

Pinout

5-Pin Eurofast	12-Pin Multifast®	19-Pin Multifast
Female	Male	Male

Junction Box Connectivity Products

Multibox® Eurofast® Junction Boxes, Back Exit Home Run

- 8-Port Plastic Housing
- 9 Amps Total
- Back Exit Home Run Cable or Leads
- Nickel Plated Brass or Stainless Steel Connectors



8-Port, 10-48 VDC, 2 Signals per Port, Back Exit Home Run Leads

Application	Specifications	Pinout	Part Number - Nickel Plated	Part Number - Stainless Steel
8-port J-box 2 signals per port Back exit leads	4 A/port, 9 A total 5-pin Eurofast connector, 1 (green) power LED 2 (yellow) signal per port LEDs, 3x18 AWG, 16x22 AWG	<u>Function</u>		
		+V	19 / BN	
		-V	6 / BU	
		Ground	12 / GN / YE	
		Port 1, Sig 1	15 / WH	
		Port 1, Sig 2	7 / GY / PK	
		Port 2, Sig 1	5 / GN	
		Port 2, Sig 2	4 / RD / BU	
		Port 3, Sig 1	16 / YE	
		Port 3, Sig 2	8 / WH / GN	
		Port 4, Sig 1	3 / GY	
		Port 4, Sig 2	14 / BN / GN	
		Port 5, Sig 1	17 / PK	
		Port 5, Sig 2	9 / WH / YE	
		Port 6, Sig 1	2 / RD	
		Port 6, Sig 2	13 / YE / BN	
		Port 7, Sig 1	11 / BK	
Port 7, Sig 2	10 / WH / GY			
Port 8, Sig 1	1 / VT			
Port 8, Sig 2	18 / GY / BN			
			8MB12-5P3-*BL	8MBV12-5P3-*BL

8-Port, 10-48 VDC, 2 Signals per Port, Back Exit Home Run Cable

Application	Specifications	Pinout	Part Number - Nickel Plated	Part Number - Stainless Steel
8-port J-box 2 signals per port Back exit cable	4 A/port, 9 A total 5-pin Eurofast connector, 1 (green) power LED 2 (yellow) signal per port LEDs, 3x18 AWG, 16x22 AWG, PVC Yellow Cable	<u>Function</u>		
		+V	19 / BN	
		-V	6 / BU	
		Ground	12 / GN / YE	
		Port 1, Sig 1	15 / WH	
		Port 1, Sig 2	7 / GY / PK	
		Port 2, Sig 1	5 / GN	
		Port 2, Sig 2	4 / RD / BU	
		Port 3, Sig 1	16 / YE	
		Port 3, Sig 2	8 / WH / GN	
		Port 4, Sig 1	3 / GY	
		Port 4, Sig 2	14 / BN / GN	
		Port 5, Sig 1	17 / PK	
		Port 5, Sig 2	9 / WH / YE	
		Port 6, Sig 1	2 / RD	
		Port 6, Sig 2	13 / YE / BN	
		Port 7, Sig 1	11 / BK	
Port 7, Sig 2	10 / WH / GY			
Port 8, Sig 1	1 / VT			
Port 8, Sig 2	18 / GY / BN			
			8MB12-5P3-*B	8MBV12-5P3-*B

* Cable length in meters.

(PNP LED Version)
2 Signals per Port

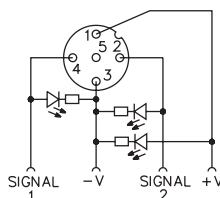

We reserve the right to make technical alterations without prior notice.

Specifications

Housing:	Nylon	Temperature:	-30 °C to +80 °C (-22 °C to +176 °F)
Connectors:	Eurofast: Nylon or TPU	Protection:	IP67
Contacts:	Gold plated brass	Accessories:	Includes (2) VZ 3 closure caps
Thread Inserts:	Nickel plated brass	Recommended Splitter:	YB2-FSM 4.5-2 FKM 4.5
Cable:	See table		
Recommended Gasket:	Gasket, 8MB12, Neoprene (A9446)		

Dimensions

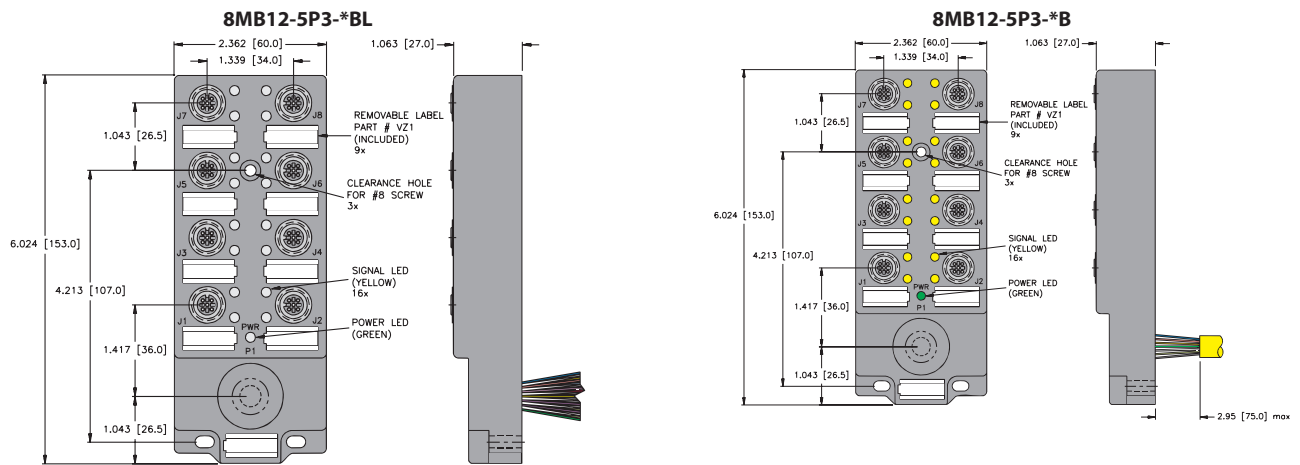

We reserve the right to make technical alterations without prior notice.

multibox®, eurofast®

Pinout

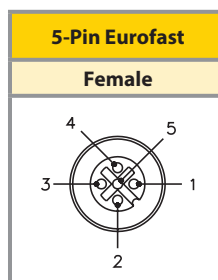

Junction Box Connectivity Products

Multibox® Eurofast® Junction Boxes, NAMUR, 1 Circuit per Port

- 4 Ports
- Rugged Plastic Housing with Flush Connectors
- M12 or M23 Quick Disconnect or Integral Home Run Cable
- For use with NAMUR Sensors



1 circuit per Port, common positive, 100 VDC

Application	Specifications	Pinout				Part Number
1 circuit per port, common positive, 100 VDC	4 A/port, 9 A total Blue PVC cable, PLTC 5x22 AWG	<u>Function</u> +V	<u>Color</u> GN	<u>Function</u> J1/Pin 2 J2/Pin 2 J3/Pin 2 J4/Pin 2	<u>Color</u> WH OG BK RD	VB 40N-*
4-port J-box 1 circuit per port Eurofast connector	4 A/port, 4 A total 5-pin Eurofast connector 5 conductors. Mates with RKCN 5T-*	<u>Function</u> +V	<u>Pin / Color</u> 1 / GN	<u>Function</u> J1/Pin 2 J2/Pin 2 J3/Pin 2 J4/Pin 2	<u>Pin / Color</u> 2 / WH 3 / OG 4 / BK 5 / RD	VB 40N-H1151

1 circuit per Port, isolated circuits, 100 VDC

Application	Specifications	Pinout				Part Number
4-port J-box 1 circuit per port Integral cable	4 A/port, 9 A total Blue PVC cable, PLTC 9x22 AWG	<u>Function</u> J1/Pin 1 J1/Pin 2 J2/Pin 1 J2/Pin 2	<u>Pin / Color</u> WH BK GN RD	<u>Function</u> J3/Pin 1 J3/Pin 2 J4/Pin 1 J4/Pin 2	<u>Pin / Color</u> OG BU YE VT	VB 4X1N-*
Brown not used						
4-port J-box 1 circuit per port Multifast® connector	4 A/port, 8 A total 12-pin Multifast connector 9 conductors. Mates with CKNM 12-9-*	<u>Function</u> J1/Pin 1 J1/Pin 2 J2/Pin 1 J2/Pin 2	<u>Pin / Color</u> 2 / WH 3 / BK 4 / GN 5 / RD	<u>Function</u> J3/Pin 1 J3/Pin 2 J4/Pin 1 J4/Pin 2	<u>Pin / Color</u> 6 / OG 7 / BU 8 / YE 9 / VT	VB 4X1N-CS12
Pin 1/BN not used						

We reserve the right to make technical alterations without prior notice.

Functional Wiring Diagrams

(PNP LED Version)
1 Signal per Port

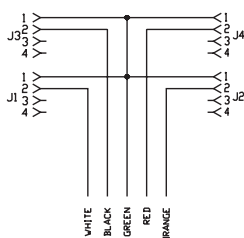

VB 40N-*

Common Positive
Eurofast Connector

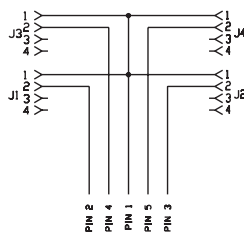

VB 40N-H1151

Isolated Circuit
Integral Cable

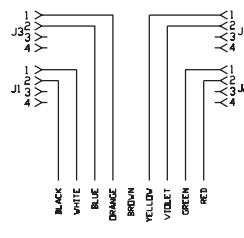

VB 4X1N-*

Isolated Circuit
Multifast Connector

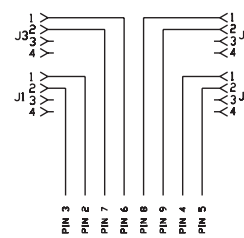

VB 4X1N-CS12

Specifications

Housing:	Nylon	Temperature:	-40 °C to +90 °C (-40 °F to +194 °F)
Connectors:	Eurofast: Nylon or TPU	Protection:	IEC IP67
Contacts:	Gold plated brass, machined from solid stock	Accessories:	(2) VZ 3 closure caps and one VZ 1 label kit (8 labels) included
Thread Inserts:	Nickel plated brass	Cable Length:	Standard length for junction boxes and Multifast® series quick disconnect cordsets is nominal 5 meters
Cable:	See table		

Dimensions

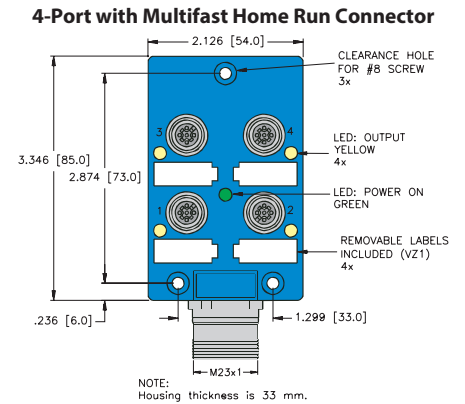
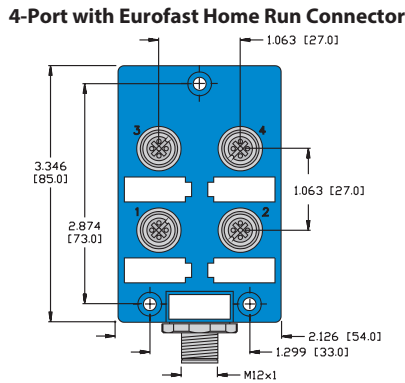
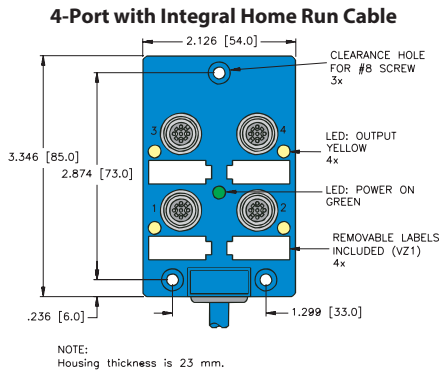

We reserve the right to make technical alterations without prior notice.

Notes

- Removable labels included (Part number VZ 1).
- Clearance hole for #8 screw (3 places).
- Housings with integral cable: 23 mm thickness. Housings with quick disconnect: 33 mm thickness.

Pinout

5-Pin Eurofast	12-Pin Multifast
Female	Male

Female Pinout Diagram

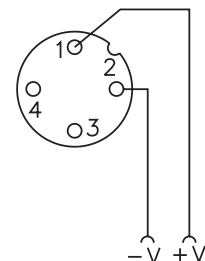

multibox®, eurofast®

Junction Box Connectivity Products

Multibox® Eurofast® Junction Boxes, NAMUR, 2 Circuits per Port

- 4 Ports
- Rugged Plastic Housing with Flush Connectors
- M12 or M23 Quick Disconnect or Integral Home Run Cable
- For use with NAMUR Sensors



2 Circuits per Port, Common Positive, 100 VDC

Application	Specifications	Pinout				Part Number
4-port J-box 2 circuits per port Integral cable	4 A/port, 9 A total Blue PVC cable, PLTC 9x22 AWG	<u>Function</u>	<u>Color</u>	<u>Function</u>	<u>Color</u>	VB 40.5N-*
		V+	BN	J3/Pin 2	OG	
		J1/Pin 2	WH	J3/Pin 4	BU	
		J1/Pin 4	BK	J4/Pin 2	YE	
		J2/Pin 2	GN	J4/Pin 4	VT	
4-port J-box 2 circuits per port Multifast® connector	4 A/port, 8 A total 12-pin Multifast connector 9 conductors. Mates with CKNM 12-9-*	<u>Function</u>	<u>Pin / Color</u>	<u>Function</u>	<u>Pin / Color</u>	VB 40.5N-CS12
		V+	1 / BN	J3/Pin 2	6 / OG	
		J1/Pin 2	2 / WH	J3/Pin 4	7 / BU	
		J1/Pin 4	3 / BK	J4/Pin 2	8 / YE	
		J2/Pin 2	4 / GN	J4/Pin 4	9 / VT	

2 Circuits per Port, Isolated Circuits, 100 VDC

Application	Specifications	Pinout				Part Number
4-port J-box 2 circuits per port Integral cable	4 A/port, 9 A total Blue PVC cable, PLTC 16x22 AWG	<u>Function</u>	<u>Color</u>	<u>Function</u>	<u>Color</u>	VB 4X1.5N-*
		J1/Pin 1	WH	J3/Pin 1	VT	
		J1/Pin 2	BK	J3/Pin 2	GY	
		J1/Pin 3	GN	J3/Pin 3	PK	
		J1/Pin 4	RD	J3/Pin 4	TN	
		J2/Pin 1	OG	J4/Pin 1	WH / BK	
		J2/Pin 2	BU	J4/Pin 2	WH / GN	
		J2/Pin 3	BN	J4/Pin 3	WH / RD	
4-port J-box 2 circuits per port Multifast cable	4 A/port, 8 A total 16-pin Multifast connector 16 conductors. Mates with CKNWM 16-16-*	<u>Function</u>	<u>Color</u>	<u>Function</u>	<u>Color</u>	VB 4X1.5N-CS16
		J1/Pin 1	1/WH	J3/Pin 1	9/VT	
		J1/Pin 2	2/BK	J3/Pin 2	10/GY	
		J1/Pin 3	3/GN	J3/Pin 3	11/PK	
		J1/Pin 4	4/RD	J3/Pin 4	12/TN	
		J2/Pin 1	5/OG	J4/Pin 1	13 / WH / BK	
		J2/Pin 2	6/BU	J4/Pin 2	14 / WH / GN	
		J2/Pin 3	7/BN	J4/Pin 3	15 / WH / RD	
J2/Pin 4	8/YE	J4/Pin 4	16 / WH / BU			

We reserve the right to make technical alterations without prior notice.

Functional Wiring Diagrams

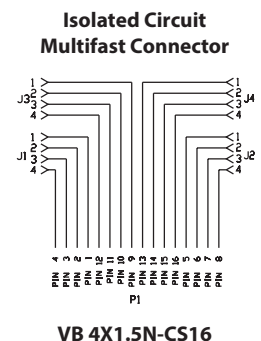
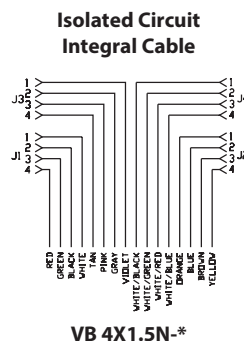
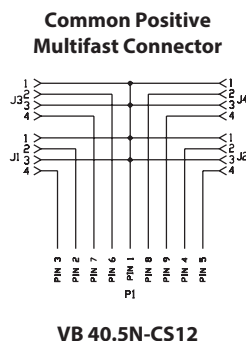
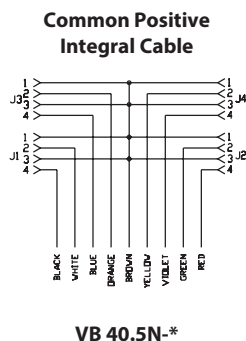

Specifications

Housing:	Nylon	Temperature:	-40 °C to +90 °C (-40 °F to +194 °F)
Connectors:	Eurofast: Nylon or TPU	Protection:	IEC IP67
Contacts:	Gold plated brass, machined from solid stock	Accessories:	(2) VZ 3 closure caps and one VZ 1 label kit (8 labels) included
Thread Inserts:	Nickel plated brass	Cable Length:	Standard length for junction boxes and Multifast® series quick disconnect cordsets is nominal 5 meters
Cable:	See table		

Dimensions

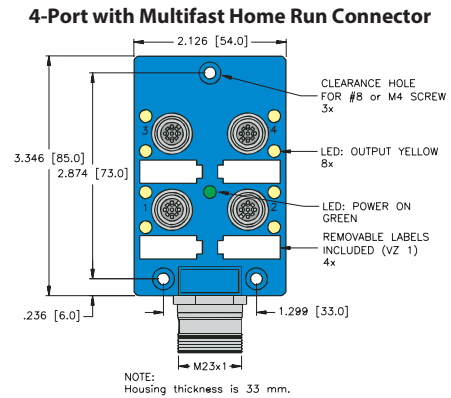
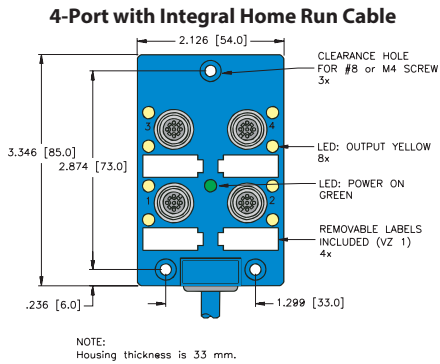

We reserve the right to make technical alterations without prior notice.

multibox®, eurofast®

Notes

- Removable labels included (Part number VZ 1).
- Clearance hole for #8 screw (3 places).
- Housings with integral cable: 23 mm thickness. Housings with quick disconnect: 33 mm thickness.

Pinout

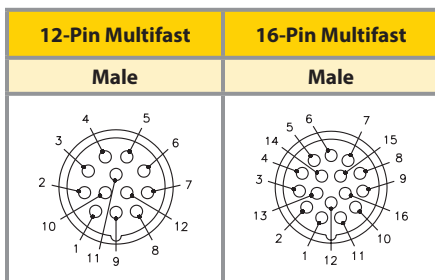

Female Pinout Diagram

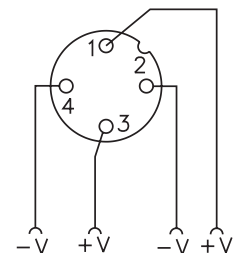

Junction Box Connectivity Products

Multibox® Eurofast® Terminal Chamber, 2 Signals per Port

- 4-Port, Plastic or Metal Housing
- Up to 16 A total
- Power Supply Isolation option
- Plug-in Terminal Cover with Spring Clamps or Screw Terminal



4-Port, 10-30 VDC, 2 Signals per Port, Isolated Power Supply Optional, Plastic Housing

Termination Style

Application	Specifications	Pinout		Spring Clamp	Screw Terminals
4-port J-box 2 signals per port Jumper option for isolation between odd and even ports Terminal chamber connection - spring clamp or screw terminals	2 A/signal, 10 A total or 8 A per supply 5-pin Eurofast connector 2(green) power LED 2(yellow) signal per port LEDs cable diameter 5-12 mm	<u>Function</u>	<u>Terminal Pin</u>	4MB12-5P4-K-FK	4MB12-5P4-K-SK
		Port 1/Signal 1	1		
		2/1	2		
		3/1	3		
		4/1	4		
		Port 1/Signal 2	9		
		2/2	10		
		3/2	11		
		4/2	12		
		+V	17		
		-V	18		
		+V	19		
-V	20				
Ground	PE				

4-Port, 10-30 VDC, 2 Signals per Port, Shielded Metal Housing

Termination Style

Application	Specifications	Pinout		Spring Clamp	Screw Terminals
4-port J-box 2 signals per port Termination chamber connection - spring clamp or screw terminals	2 A/signal, 10 A total 5-pin Eurofast connector 1(green) power LED cable diameter 9-14 mm	<u>Function</u>	<u>Terminal Pin</u>	----	4MB12-5P1-MS-SK
		Port 1/Signal 1	1		
		2/1	2		
		3/1	3		
		4/1	4		
		Port 1/Signal 2	9		
		2/2	10		
		3/2	11		
		4/2	12		
		+V	17		
		-V	18		
		+V	19		
-V	20				
Ground	PE				

We reserve the right to make technical alterations without prior notice.

Functional Wiring Diagrams

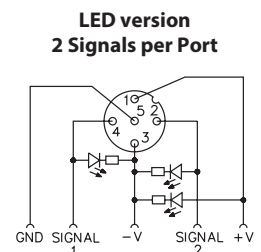
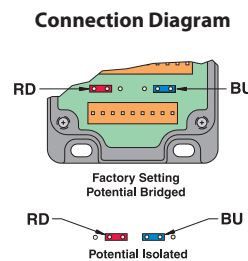
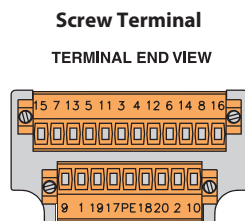
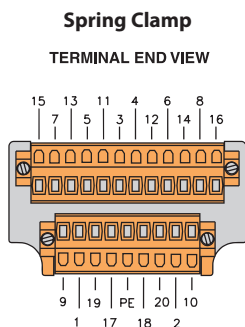

Multibox® Eurofast® Terminal Chamber, 2 Signals per Port

Specifications

Housing:	PBT Black Plastic	Temperature:	-20 °C to +90 °C (-4 °F to +194 °F)
Connectors:	Eurofast: PBT/black	Protection:	IEC IP68
Contacts:	Gold plated brass	Accessories:	(2) TC-CC closure caps and labels included
Thread Inserts:	Nickel plated brass	Termination Method:	Field wireable, Spring Clamp or Screw Terminal. 16 AWG max.
Cable Gland & OD:	PG 13.5, accepts cable diameter 5 to 12 mm		
Recommended Splitter:	YB2-FSM 4.5-2 FKM 4.5		

Dimensions

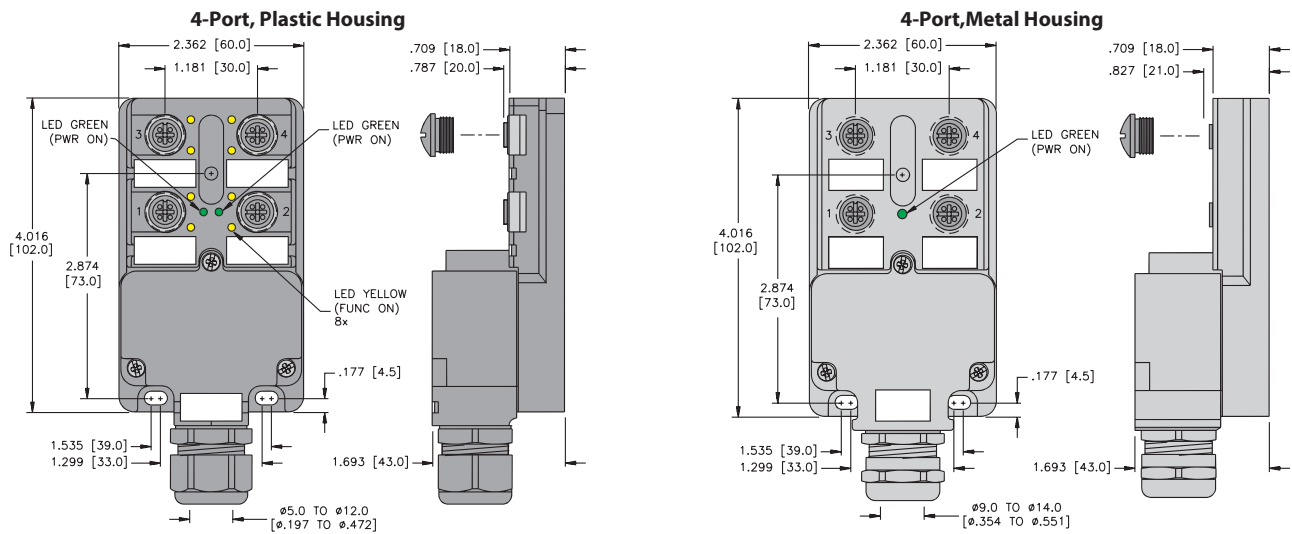

We reserve the right to make technical alterations without prior notice.

multibox®, eurofast®

Pinout

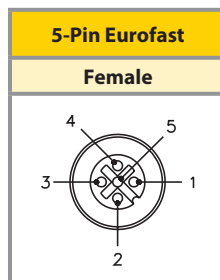

Junction Box Connectivity Products

Multibox® Eurofast® Terminal Chamber, 2 Signals per Port

- 8-Port Plastic or Metal Housing
- Up to 16 A total
- Power Supply Isolation option
- Plug-in Terminal Cover with Spring Clamps or Screw Terminal



8-Port, 10-30 VDC, 2 Signals per Port, Isolated Power Supply Optional, Plastic

Termination Style

Application	Specifications	Pinout				Spring Clamp	Screw Terminals
		Function	Terminal Pin	Function	Terminal Pin		
8-port J-box 2 signals per port, Jumper option for isolation between odd and even ports Terminal chamber connection - spring clamp or screw terminals	2 A/signal, 10 A total or 8 A per supply 5-pin Eurofast connector 2 (green) power LED 2 (yellow) signal per port LEDs cable diameter 6-12 mm	Port 1/Signal 1	1	4/2	12	8MB12-5P4-K-FK	8MB12-5P4-K-SK
		2/1	2	5/2	13		
		3/1	3	6/2	14		
		4/1	4	7/2	15		
		5/1	5	8/2	16		
		6/1	6	+V	17		
		7/1	7	-V	18		
		8/1	8	+V	19		
		Port 1/Signal 2	9	-V	20		
		2/2	10	Ground	PE		
		3/2	11				

8-Port, 10-30 VDC, 2 Signals per Port, Shielded Metal

Termination Style

Application	Specifications	Pinout				Spring Clamp	Screw Terminals
		Function	Terminal Pin	Function	Terminal Pin		
8-port J-box 2 signals per port Termination chamber connection - spring clamp or screw terminal	2 A/signal, 10 A total 5-pin Eurofast connector 1 (green) power LED cable diameter 9-14 mm	Port 1/Signal 1	1	4/2	12	8MB12-5P1-MS-FK	8MB12-5P1-MS-SK
		2/1	2	5/2	13		
		3/1	3	6/2	14		
		4/1	4	7/2	15		
		5/1	5	8/2	16		
		6/1	6	+V	17		
		7/1	7	-V	18		
		8/1	8	+V	19		
		Port 1/Signal 2	9	-V	20		
		2/2	10	Ground	PE		
		3/2	11				

We reserve the right to make technical alterations without prior notice.

Functional Wiring Diagrams

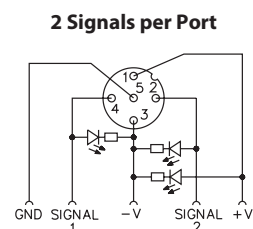
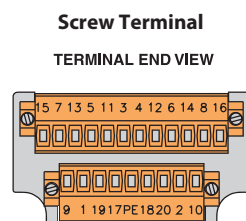
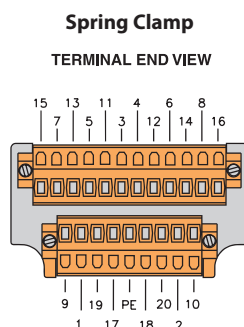

Multibox® Eurofast® Terminal Chamber, 2 Signals per Port

Specifications

Housing:	Die Cast Zinc, Nickel plated	Temperature:	-20 °C to +90 °C (-4 °F to +194 °F)
Connectors:	Eurofast: PBT/black	Protection:	IEC IP68
Contacts:	Gold plated brass	Accessories:	Includes (2) TC-CC closure caps and labels
Thread Inserts:	Nickel plated brass	Termination Method:	Field wireable, spring clamps or screw terminals. 16 AWG max.
Cable Gland & OD:	PG 13.5, accepts cable diameter 10-14 mm		
Recommended Splitter:	YB2-FSM 4.5-2 FKM 4.5		

Dimensions

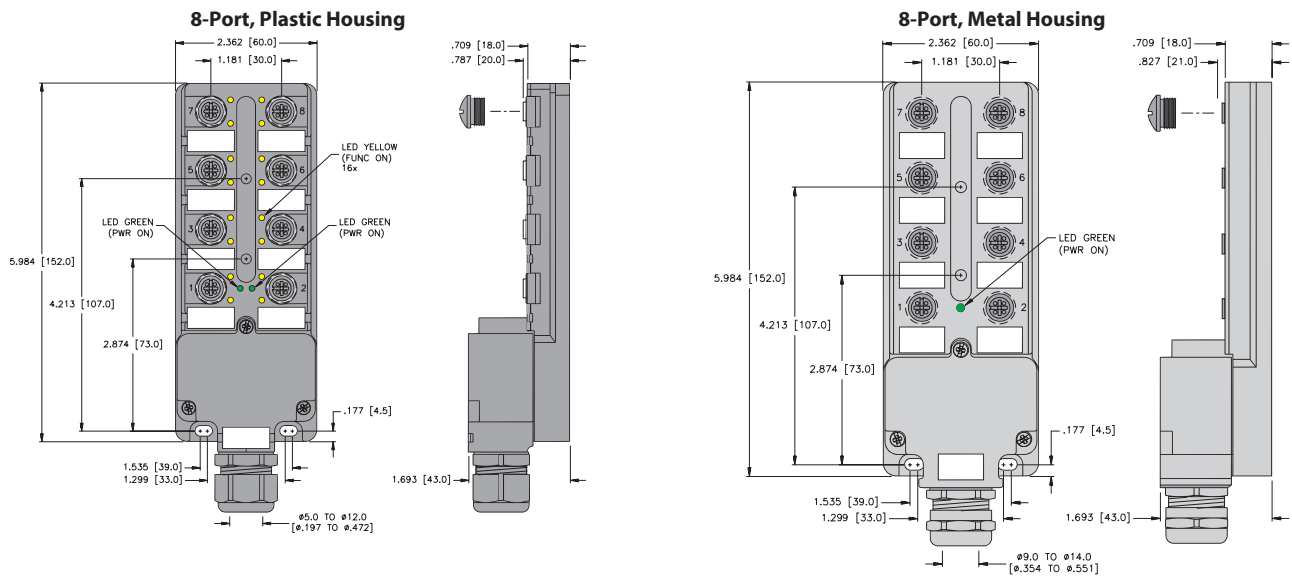

We reserve the right to make technical alterations without prior notice.

multibox®, eurofast®

Pinout

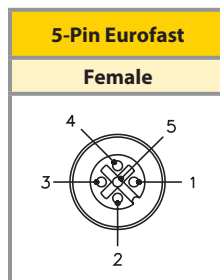

Junction Box Connectivity Products

Multibox® Eurofast® Junction Boxes, 4-Port, Metal

- Single Input/Output per Port
- Metal Housing with Side Connectors
- For DC Sensors and Actuators
- M23 Quick Disconnect, Minifast® Connector, or Integral Home Run Cable
- Available with or without LEDs



4-Port, 1 Signal per Port, 10-48 VDC

Application	Specifications	Pinout				Spring Clamp	Screw Terminals
4-port J-box 1 signal per port Metal box Integral cable	4 A/port, 10 A total Yellow PVC cable 7x18 AWG foil shield and 20 AWG drain	<u>Function</u> +V -V Ground	<u>Color</u> BN BU GN / YE	<u>Function</u> Port 1 Port 2 Port 3 Port 4	<u>Color</u> WH GN YE GY	VBM 40-*	VBM 40-P7X5-*
4-port J-box 1 signal per port Metal box Multifast® connector	4 A/port, 8 A total 12-pin Multifast connector 7 conductors. Mates with CKM 12-7-*	<u>Function</u> +V -V Ground	<u>Pin / Color</u> 1 / BN 3 / BU 12 / GN / YE	<u>Function</u> Port 1 Port 2 Port 3 Port 4	<u>Pin / Color</u> 4 / WH 6 / GN 7 / YE 8 / GY	VBM 40-CS12	VBM 40-P7X5-CS12
4-port J-box 1 signal per port, Metal box Minifast connector	4 A/port, 7 A total 12-pin Minifast connector 7 conductors. Mates with RKM 126-*M CSA Certified	<u>Function</u> +V -V Ground Port 1 Port 2	<u>Pin / Color</u> 10 / RD 11 / WH 12 / BK 1 / OG 2 / BU	<u>Function</u> Port 3 Port 4	<u>Pin / Color</u> 3 / WH/BK 4 / RD/BK	VBM 40-RSF120	VBM 40-P7X5-RSF120

We reserve the right to make technical alterations without prior notice.

Functional Wiring Diagrams

(No LED Version)
1 Signal per Port

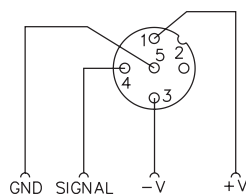

(PNP LED Version)
1 Signal per Port

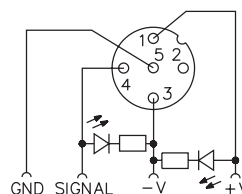

Specifications

Housing:	Die-cast aluminum alloy	Temperature:	-40 °C to +90 °C (-40 °F to +194 °F)
Connectors:	Eurofast: Nylon or TPU	Protection:	IEC IP67
Contacts:	Gold plated brass	Accessories:	(2) VZ 3 closure caps included
Thread Inserts:	Nickel plated brass	Cable Length:	Standard length for junction boxes and Multifast® series quick disconnect cordsets is nominal 5 meters Other lengths available by request. Consult factory
Cable:	See table		

Dimensions

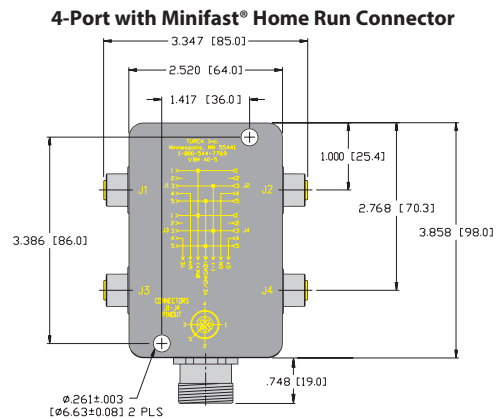
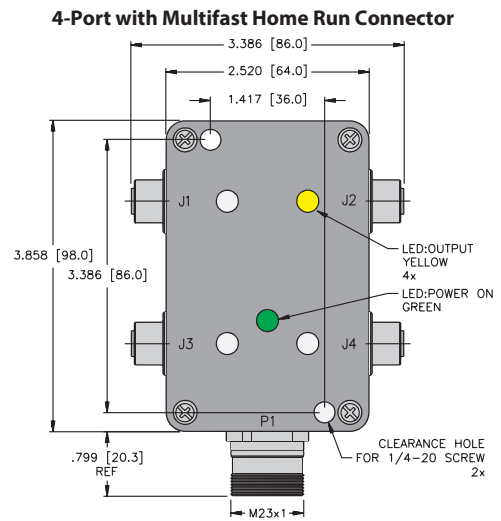
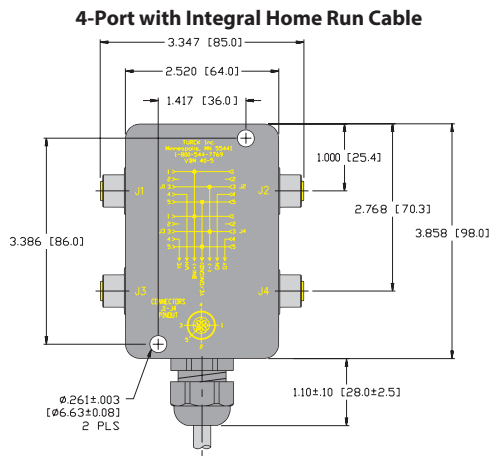

We reserve the right to make technical alterations without prior notice.

Notes

1. For mating CKM cordsets. See Multifast pages.
2. For mating RKM cordsets. See Minifast pages.

Pinout

5-Pin Eurofast	12-Pin Multifast	12-pin Minifast
Female	Male	Male

multibox®, eurofast®

Junction Box Connectivity Products

Multibox® Eurofast® Junction Boxes, 8-Port, Metal

- Single Input/Output per Port
- Metal Housing with Side Connectors
- For DC Sensors and Actuators
- M23 Quick Disconnect, Minifast Connector, or Integral Home Run Cable
- Available with or without LEDs



8-Port, 1 Signal per Port, 10-48 VDC

Application	Specifications	Pinout				Spring Clamp	Screw Terminals
8-port J-box 1 signal per port Metal box Integral cable	4 A/port, 10 A total Yellow PVC cable 11x18 AWG, foil shield and 20 AWG drain	<u>Function</u> +V -V Ground Port 1 Port 2 Port 3	<u>Color</u> BN BU GN / YE WH GN YE	<u>Function</u> Port 4 Port 5 Port 6 Port 7 Port 8	<u>Color</u> GY PK RD BK VT	VBM 80-*	VBM 80-P7X9-*
8-port J-box 1 signal per port Metal box Multifast® connector	4 A/port, 8 A total 12-pin Multifast connector 9 conductors. Mates with CKM 12-11-*	<u>Function</u> +V -V Ground Port 1 Port 2 Port 3	<u>Pin / Color</u> 1 / BN 3 / BU 12 / GN/YE 4 / WH 5 / GN 6 / YE	<u>Function</u> Port 4 Port 5 Port 6 Port 7 Port 8	<u>Pin / Color</u> 7 / GY 8 / PK 9 / RD 10 / BK 11 / VT	VBM 80-CS12	VBM 80-P7X9-CS12
8-port J-box 1 signal per port Metal box Minifast connector	4 A/port, 7 A total 12-pin Minifast connector 9 conductors. Mates with RKM 126-* CSA Certified	<u>Function</u> +V -V Ground Port 1 Port 2	<u>Pin / Color</u> 10 / RD 11 / WH 12 / BK 1 / OG 2 / BU	<u>Function</u> Port 3 Port 4 Port 5 Port 6 Port 7 Port 8	<u>Pin / Color</u> 3 / WH/BK 4 / RD/BK 5 / GN/BK 6 / OG/BK 7 / BU/BK 8 / BK/WH	VBM 80-RSF120	VBM 80-P7X9-RSF120

We reserve the right to make technical alterations without prior notice.

Functional Wiring Diagrams

(No LED Version)
1 Signal per Port

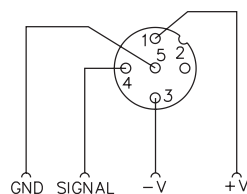

(PNP LED Version)
1 Signal per Port

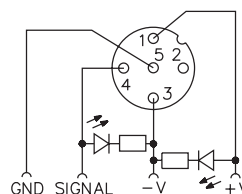

Specifications

Housing:	Die-cast aluminum alloy	Temperature:	-40 °C to +90 °C (-40 °F to +194 °F)
Connectors:	Eurofast: Nylon or TPU	Protection:	IEC IP67
Contacts:	Gold plated brass	Accessories:	(2) VZ 3 closure caps included
Thread Inserts:	Nickel plated brass	Cable Length:	Standard length for junction boxes and Multifast® series quick disconnect cordsets is nominal 5 meters Other lengths available by request. Consult factory
Cable:	See table		

Dimensions

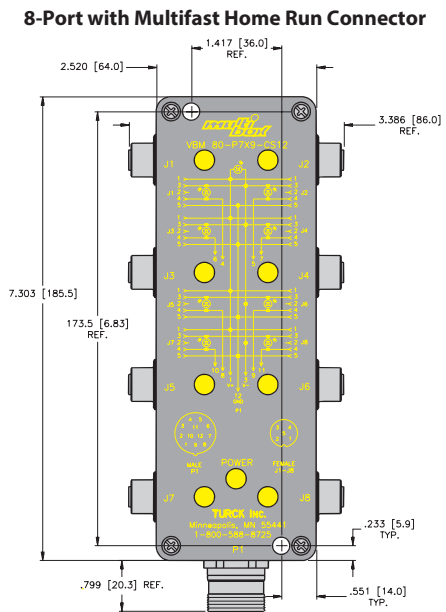
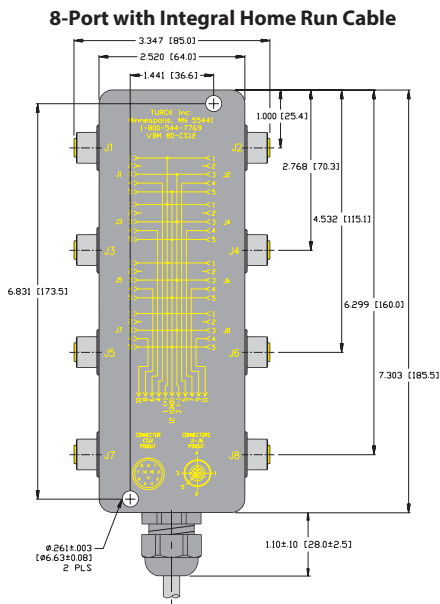

8-Port with Minifast® Home Run Connector

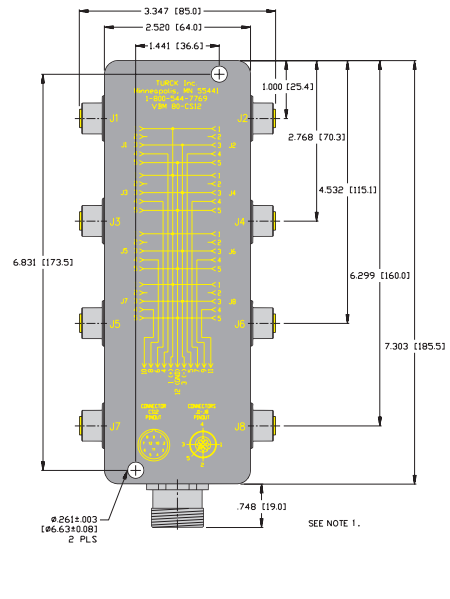

We reserve the right to make technical alterations without prior notice.

Notes

1. For mating CKM cordsets. See Multifast pages.
2. For mating RKM cordsets. See Minifast pages.

Pinout

5-Pin Eurofast	12-Pin Multifast	12-pin Minifast
Female	Male	Male

multibox®, eurofast®

Junction Box Connectivity Products

Multibox® Eurofast® Junction Box, 16-Port

- Single Input/ Output per Port
- Rugged Plastic Housing with Flush Connectors
- Quick Disconnect
- Available with LEDs



16-Port, 1-Signal per Port, 10-48 VDC

Application	Specifications	Pinout				PNP LED
16-port J-box 1 signal per port Multifast® connector	4 A/port, 8 A total 12-pin Multifast connector. Mates with CKM 19-19-*. CSA Certified	<u>Function</u>	<u>Pin / Color</u>	<u>Function</u>	<u>Pin / Color</u>	16MB12-4P2-CS19
		+V	19 / BN	Port 7	3 / GY	
		-V	6 / BU	Port 8	14 / BN / GN	
		Ground	12 / GN / YE	Port 9	17 / PK	
		Port 1	15 / WH	Port 10	9 / WH / YE	
		Port 2	7 / GY / PK	Port 11	2 / RD	
		Port 3	5 / GN	Port 12	13 / YE / BN	
		Port 4	4 / RD / BU	Port 13	11 / BK	
		Port 5	16 / YE	Port 14	10 / WH / GY	
		Port 6	8 / WH / GN	Port 15	1 / VT	
				Port 16	18 / GY / BN	

We reserve the right to make technical alterations without prior notice.

Functional Wiring Diagrams

(PNP LED Version)
1 Signal per Port

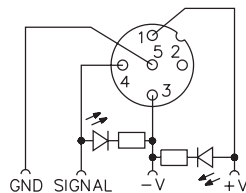

Multibox® Eurofast® Junction Box, 16-Port

Specifications

Housing:	Nylon	Temperature:	-30 °C to +80 °C (-22 °F to +176 °F)
Connectors:	Nylon/BK (1,1A-8,8A), Nitrile/Yellow (P1)	Protection:	IEC IP67
Contacts:	Gold plated brass	Accessories:	Includes (2) VZ 3 closure caps and a VZ 1 label kit (16 labels) included
Thread Inserts:	Nickel plated brass	Cable Length:	Standard length is nominal 5 meters. Other lengths available upon request - Consult factory

Dimensions

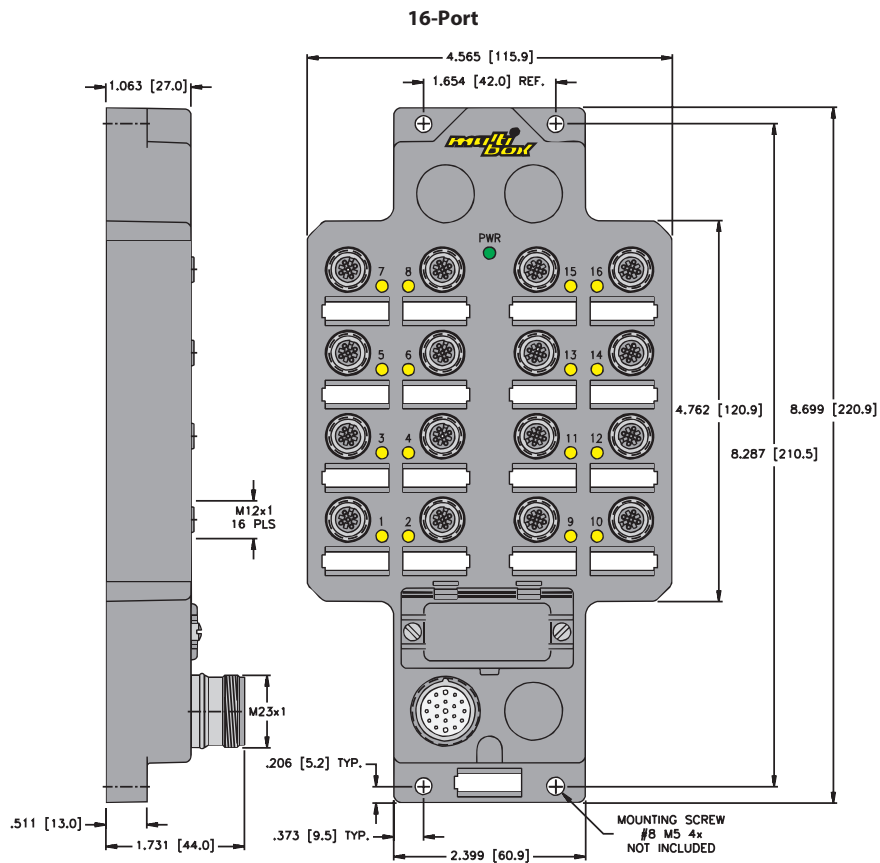

We reserve the right to make technical alterations without prior notice.

multibox®, eurofast®

Pinout

5-Pin Eurofast	19-pin Multifast®
Female	Male

Junction Box Connectivity Products

Multibox® Eurofast® AC/DC Junction Box, 4-Port

- 4 Ports for connecting DC sensors
- Integrated DC power supply
- Solid-State AC output from DC sensors
- LED shows power supply function
- Home Run wiring matches standard AC style junction boxes for easy installation



4-Port, 85-132 VAC

Application	Specifications	Pinout	Part Number																
4-port J-box for DC sensors in AC applications	85 - 132 VAC input 24 VDC output to sensors 100 mA output per port 7-pin Minifast® connector. Mates with RKM 76-*M	<table border="1"> <thead> <tr> <th>Function</th> <th>Pin/Color</th> </tr> </thead> <tbody> <tr> <td>L1 AC Common</td> <td>3 / WH</td> </tr> <tr> <td>L2 AC</td> <td>1 / WH / BK</td> </tr> <tr> <td>Ground</td> <td>7 / GN</td> </tr> <tr> <td>J1 Load (L2)</td> <td>2 / BK</td> </tr> <tr> <td>J2 Load (L2)</td> <td>4 / RD</td> </tr> <tr> <td>J3 Load (L2)</td> <td>5 / OG</td> </tr> <tr> <td>J4 Load (L2)</td> <td>6 / BU</td> </tr> </tbody> </table>	Function	Pin/Color	L1 AC Common	3 / WH	L2 AC	1 / WH / BK	Ground	7 / GN	J1 Load (L2)	2 / BK	J2 Load (L2)	4 / RD	J3 Load (L2)	5 / OG	J4 Load (L2)	6 / BU	VBM-AC/DC/AC-RSM 70/ADAPTER BOX
Function	Pin/Color																		
L1 AC Common	3 / WH																		
L2 AC	1 / WH / BK																		
Ground	7 / GN																		
J1 Load (L2)	2 / BK																		
J2 Load (L2)	4 / RD																		
J3 Load (L2)	5 / OG																		
J4 Load (L2)	6 / BU																		

We reserve the right to make technical alterations without prior notice.

Functional Wiring Diagrams

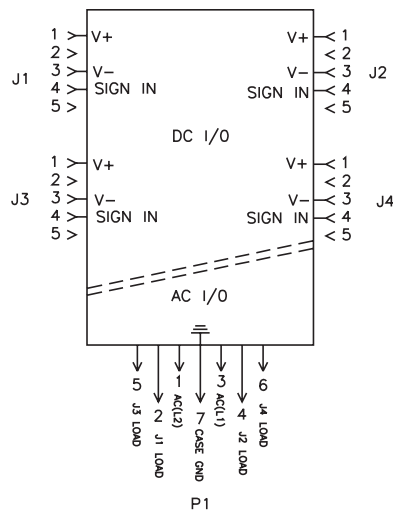

Multibox® Eurofast® AC/DC Junction Box, 4-Port

Specifications

Housing:	Die cast aluminum alloy	Temperature:	-30 °C to +70 °C (-22 °C to +158 °F)
Contact Carrier:	Eurofast: Nylon or TPU. Minifast®: TPU	Protection:	IEC IP67
Contacts:	Gold plated brass	Accessories:	VZ 3 Closure Caps (2 included)
Thread Inserts:	Nickel plated brass		

Dimensions

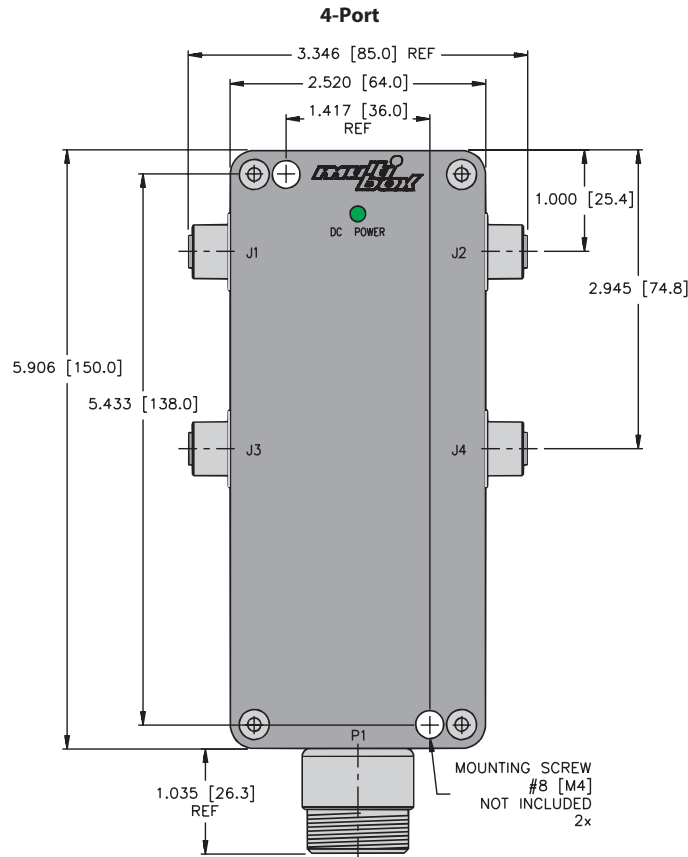

We reserve the right to make technical alterations without prior notice.

multibox®, eurofast®

Pinout

5-Pin Eurofast	7-pin Minifast®
Female	Male

Junction Box Connectivity Products

Multibox® Picofast® Junction Boxes, 4-Port, 3-Pin

- Snap Lock or Threaded Connectors
- Available with or without LEDs
- M12 Quick Disconnect or Integral Home Run Cable



4-Port, Snap Lock, 10-30 VDC

Application	Specifications	Pinout	No LEDs	PNP LED	NPN LED
4 port J-box, 1 signal per port, snap lock port connectors, integral homerun cable	2 A/ signal, 6 A total Black PVC cable 6x24 AWG	<u>Function</u>	TB-4M8Z-3-*	TB-4M8Z-3P2-*	TB-4M8Z-3N2-*
		<u>Color</u>			
4 port J-box, 1 signal per port, snap lock port connectors, Eurofast(R) homerun connector	2 A/ signal, 2 A total 8-pin Eurofast connector 6 conductors. Mates with RKC 8.6T-*	<u>Function</u>	TB-4M8Z-3-FS8	TB-4M8Z-3P2-FS8	TB-4M8Z-3N2-FS8
		<u>Pin</u>			
		+V			
		-V			
		Port 1			
		Port 2			
		Port 3			
		Port 4			

4-Port, Threaded, 10-30 VDC

Application	Specifications	Pinout	No LEDs	PNP LED	NPN LED
4 port J-box, 1 signal per port, threaded port connectors, integral homerun cable	2 A/signal, 6 A total Black PVC cable 6x24 AWG	<u>Function</u>	TB-4M8M-3-*	TB-4M8M-3P2-*	TB-4M8M-3N2-*
		<u>Color</u>			
4 port J-box, 1 signal per port, threaded port connectors, Eurofast(R) homerun connector	2 A/ signal, 2 A total 8-pin Eurofast connector 6 conductors. Mates with RKC 8.6T-*	<u>Function</u>	TB-4M8M-3-FS8	TB-4M8M-3P2-FS8	TB-4M8M-3N2-FS8
		<u>Pin</u>			
		+V			
		-V			
		Port 1			
		Port 2			
		Port 3			
		Port 4			

We reserve the right to make technical alterations without prior notice.

Functional Wiring Diagrams

No LED Version

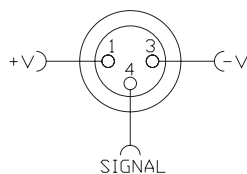

LED Version

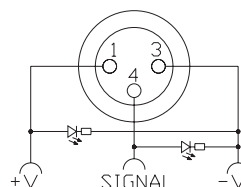

Specifications

Housing:	Nylon	Temperature:	-40 °C to +85 °C (-40 °F to +185 °F)
Connectors:	Nylon or TPU	Protection:	IEC IP67 (all) , IP68 (threaded only)
Contacts:	Gold plated brass	Accessories:	2 pieces PSGK-MC (snap lock) or PSGM-CC (threaded) and 5 pieces KS 5/10 labels included
Thread Inserts:	Nickel plated brass	Cable Length:	Standard length is nominal 5 meters Other lengths available by request - Consult factory
Cable:	See table		

Dimensions

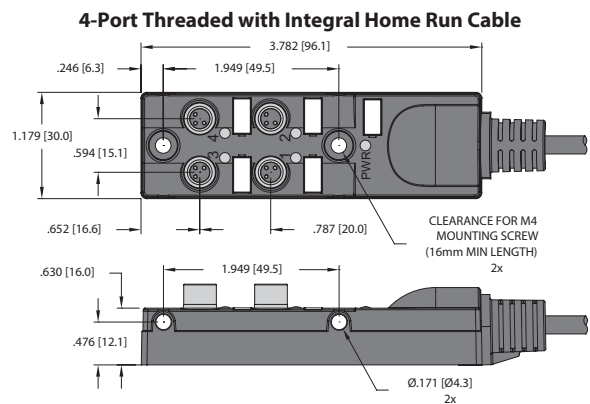
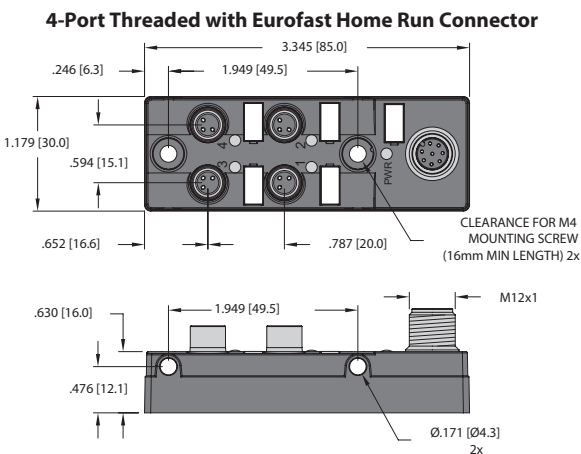
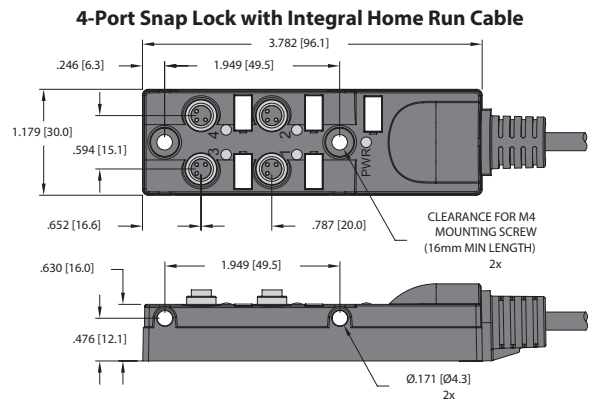
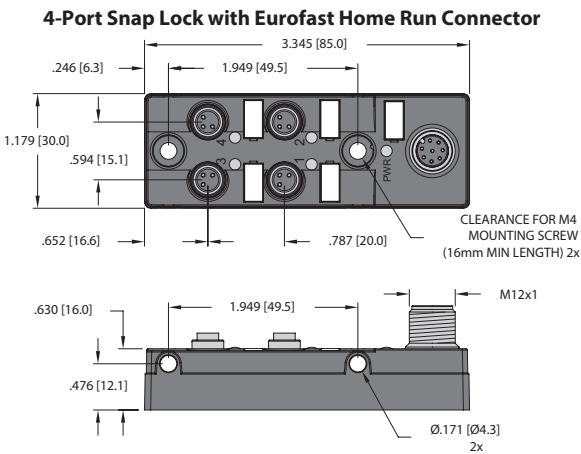

We reserve the right to make technical alterations without prior notice.

multibox®, picofast®

Pinout

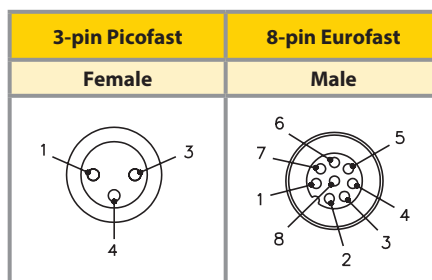

Junction Box Connectivity Products

Multibox® Picofast® Junction Boxes, 8-Port, 3-Pin

- Snap Lock or Threaded Connectors
- Available with or without LEDs
- M12 Quick Disconnect or Integral Home Run Cable



8-Port, Snap Lock, 10-30 VDC

Application	Specifications	Homerun Pinout				No LEDs	PNP LED	NPN LED
8 port J-box, 1 signal per port, snap lock port connectors, integral homerun cable	2 A/signal, 6 A total Black PVC cable 10x24 AWG	<u>Function</u>	<u>Color</u>	<u>Function</u>	<u>Color</u>	TB-8M8Z-3-*	TB-8M8Z-3P2-*	TB-8M8Z-3N2-*
		+V	BN	Port 4	GY			
		-V	BU	Port 5	PK			
		Port 1	WH	Port 6	RD			
		Port 2	GN	Port 7	BK			
		Port 3	YE	Port 8	VT			
8 port J-box, 1 signal per port, snap lock port connectors, Eurofast(R) homerun connector	2 A/port, 2 A total for single power, mates with RKC 10T*/S3477 2 A/port, 4A total for dual power, mates with RKC 12T*/S3477	<u>Function</u>	<u>Pin</u>	<u>Function</u>	<u>Pin</u>	TB-8M8Z-3-FS12	TB-8M8Z-3P2-FS12	TB-8M8Z-3N2-FS12
		+V	1, 12	Port 4	8			
		-V	2, 11	Port 5	5			
		Port 1	3	Port 6	9			
		Port 2	4	Port 7	7			
		Port 3	6	Port 8	10			

8-Port, Threaded, 10-30 VDC

Application	Specifications	Homerun Pinout				No LEDs	PNP LED	NPN LED
8 port J-box, 1 signal per port, snap lock port connectors, Eurofast(R) homerun connector	2 A/port, 6 A total Black PVC cable 10x24 AWG	<u>Function</u>	<u>Color</u>	<u>Function</u>	<u>Color</u>	TB-8M8M-3-*	TB-8M8M-3P2-*	TB-8M8M-3N2-*
		+V	BN	Port 4	GY			
		-V	BU	Port 5	PK			
		Port 1	WH	Port 6	RD			
		Port 2	GN	Port 7	BK			
		Port 3	YE	Port 8	VT			
8 port J-box, 1 signal per port, threaded port connectors, Eurofast(R) homerun connector	2 A/port, 2 A total for single power, mates with RKC 10T*/S3477 2 A/port, 4A total for dual power, mates with RKC 12T*/S3477	<u>Function</u>	<u>Pin</u>	<u>Function</u>	<u>Pin</u>	TB-8M8M-3-FS12	TB-8M8M-3P2-FS12	TB-8M8M-3N2-FS12
		+V	1, 12	Port 4	8			
		-V	2, 11	Port 5	5			
		Port 1	3	Port 6	9			
		Port 2	4	Port 7	7			
		Port 3	6	Port 8	10			

We reserve the right to make technical alterations without prior notice.

Functional Wiring Diagrams

No LED Version

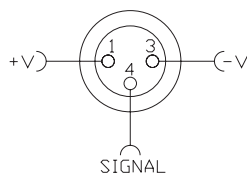

LED Version

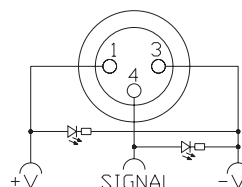

Specifications

Housing:	Nylon	Temperature:	-40 °C to +85 °C (-40 °F to +185 °F)
Connectors:	Nylon or TPU	Protection:	IEC IP67 (all) , IP68 (threaded only)
Contacts:	Gold plated brass	Accessories:	2 pieces PSGK-MC (snap lock) or PSGM-CC (threaded) and 9 pieces KS 5/10 labels included
Thread Inserts:	Nickel plated brass	Cable Length:	Standard length is nominal 5 meters Other lengths available by request - Consult factory
Cable:	See table		

Dimensions

8-Port Snap Lock with Eurofast Home Run Connector

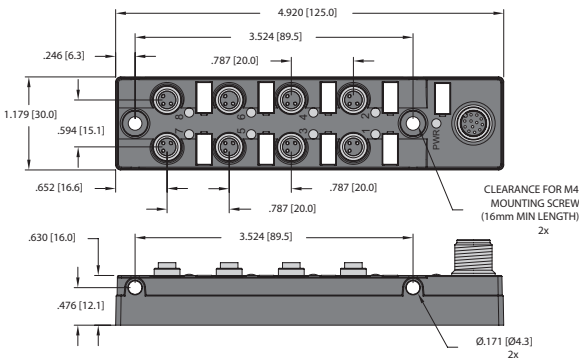

8-Port Snap Lock with Integral Home Run Cable

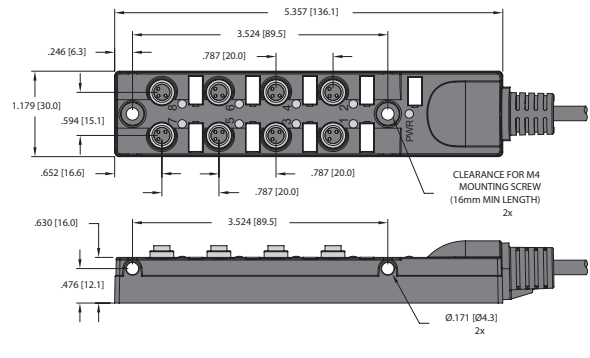

8-Port Threaded with Eurofast Home Run Connector

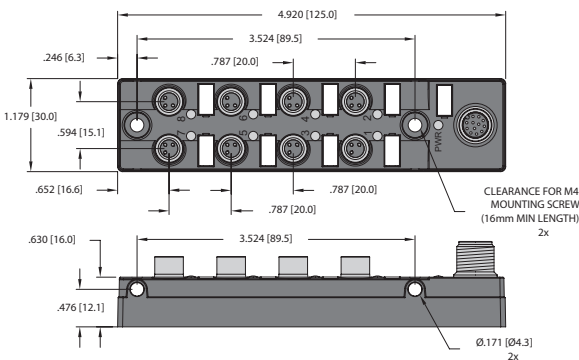

8-Port Threaded with Integral Home Run Cable

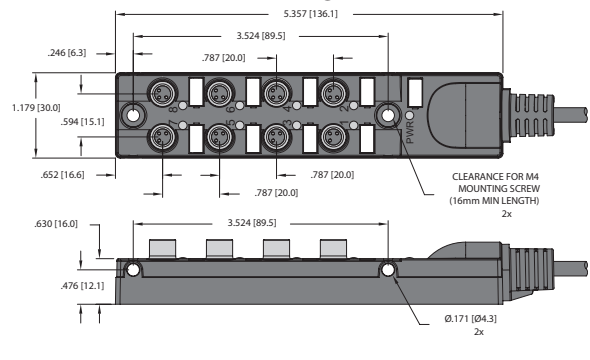

We reserve the right to make technical alterations without prior notice.

multibox®, picofast®

Pinout

3-pin Picofast	12-pin Eurofast™
Female	Male

Junction Box Connectivity Products

Multibox® Picofast® Junction Boxes, 4-Port, 4-pin

- Dual Input/Output per Port
- Snap Lock or Threaded Connectors
- M12 Quick Disconnect or Integral Home Run Cable



4-Port, 4-pin, Snap Lock, 10-30 VDC

Application	Specifications	Pinout				No LEDs
4 port J-box, 2 signals per port, snap lock port connectors, integral homerun cable	2 A/signal, 6 A total black PVC cable 10x24 AWG	<u>Function</u>	<u>Color</u>	<u>Function</u>	<u>Color</u>	TB-4M8Z-4-*
		+V	BN	Port 3/2	GN	
4 port J-box, 2 signals per port, snap lock port connectors, Eurofast(R) homerun connector	2 A/signal, 2 A total for single power, mates with RKC 10T*/S3476 2 A/signal, 4A total for dual power, mates with RKC 12T*/S3476	-V	BU	Port 3/4	WH	TB-4M8Z-4-FS12
		Port 1/2	RD	Port 4/2	BK	
		Port 1/4	PK	Port 4/4	VT	
		Port 2/2	YE			
		Port 2/4	GY			
		<u>Function</u>	<u>Pin</u>	<u>Function</u>	<u>Pin</u>	
		+V	1, 12	Port 2/2	9	
		-V	2, 11	Port 2/4	4	
		Port 1/2	5	Port 3/2	7	
		Port 1/4	3	Port 3/4	6	
				Port 4/2	10	
				Port 4/4	8	

4-Port, 4-pin, Threaded, 10-30 VDC

Application	Specifications	Pinout				No LEDs
4 port J-box, 2 signals per port, threaded port connectors, integral homerun cable	2 A/signal, 6 A total Black PVC cable 10x24 AWG	<u>Function</u>	<u>Color</u>	<u>Function</u>	<u>Color</u>	TB-4M8M-4-*
		+V	BN	Port 2/4	GY	
4 port J-box, 2 signals per port, threaded port connectors, Eurofast(R) homerun connector	2 A/signal, 2 A total for single power, mates with RKC 10T*/S3476 2 A/signal, 4A total for dual power, mates with RKC 12T*/S3476	-V	BU	Port 3/2	GN	TB-4M8M-4-FS12
		Port 1/2	RD	Port 3/2	WH	
		Port 1/4	PK	Port 4/2	BK	
		Port 2/2	YE	Port 4/4	VT	
		<u>Function</u>	<u>Pin</u>	<u>Function</u>	<u>Pin</u>	
		+V	1, 12	Port 2/2	9	
		-V	2, 11	Port 2/4	4	
		Port 1/2	5	Port 3/2	7	
		Port 1/4	3	Port 3/4	6	
				Port 4/2	10	
				Port 4/4	8	

* Cable length in meters.

We reserve the right to make technical alterations without prior notice.

Functional Wiring Diagrams

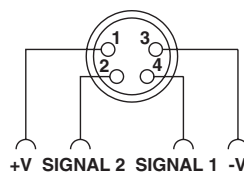

Specifications

Housing:	Nylon	Temperature:	-40 °C to +85 °C (-40 °F to +185 °F)
Connectors:	Nylon or TPU	Protection:	IEC IP67 (all) , IP68 (threaded only)
Contacts:	Gold plated brass	Accessories:	2 pieces PSGK-MC (snap lock) or PSGM-CC (threaded) and 5 pieces KS 5/10 labels included
Thread Inserts:	Nickel plated brass	Cable Length:	Standard length is nominal 5 meters Other lengths available by request - Consult factory
Cable:	See table	Recommended Splitter:	YP2-MFS 4/2MFK 3, for threaded version only

Dimensions

4-Port Snap Lock with Eurofast Home Run Connector

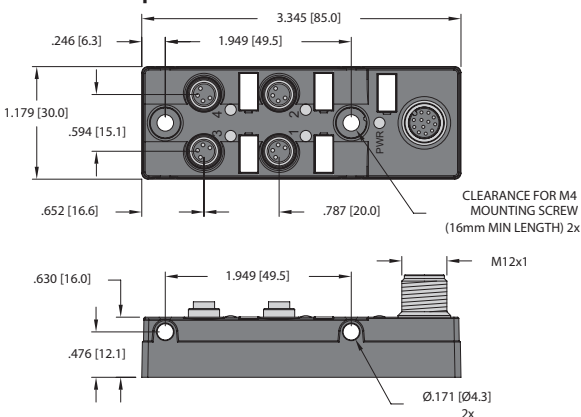

4-Port Snap Lock with Integral Home Run Cable

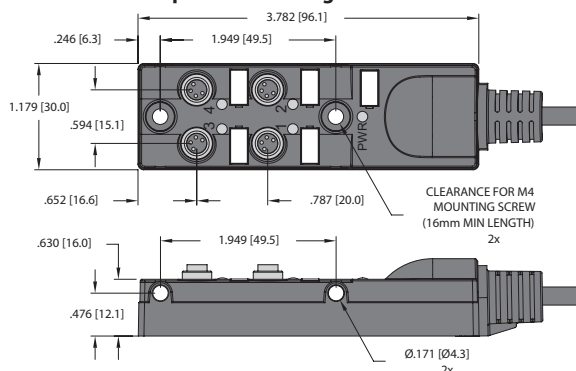

4-Port Threaded with Eurofast Home Run Connector

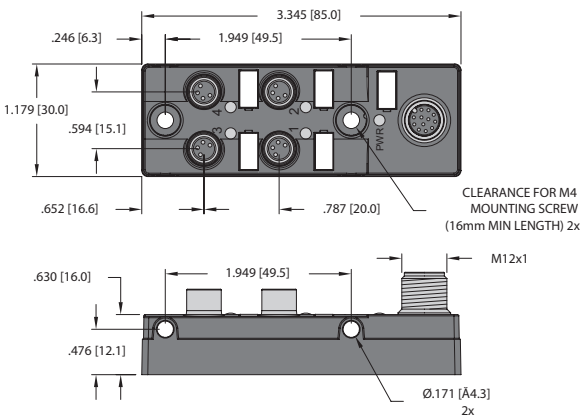

4-Port Threaded with Integral Home Run Cable

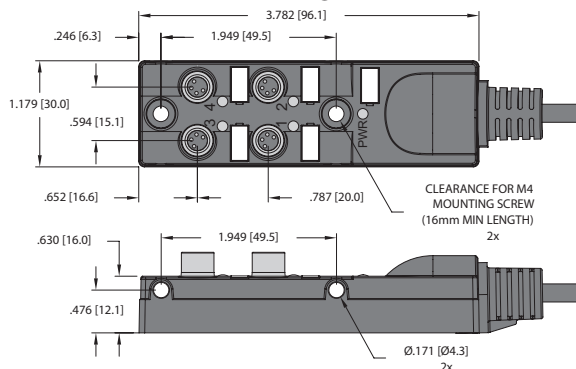

We reserve the right to make technical alterations without prior notice.

multibox®, picofast®

Pinout

4-pin Picofast	12-pin Eurofast
Female	Male

Junction Box Connectivity Products

Multibox® Picofast® Junction Boxes, 8-Port, 4-pin

- Dual Input/Output per Port
- Snap Lock or Threaded Connectors
- Integral Home Run Cable or M16 Cordset



4-Port, 4-pin, Snap Lock, 10-48 VDC

Application	Specifications	Homerun Pinout				No LEDs
8 port J-box, 2 signals per port, snap lock port connectors, integral homerun cable	2 A / signal, 6 A total Black PVC cable 19x22 AWG	<u>Function</u>	<u>Color</u>	<u>Function</u>	<u>Color</u>	TB-8M8Z-4.*
		- V	BU	Port 4/4	WH	
		+V	BN	Port 5/2	PK	
		Port 1/2	RD	Port 5/4	GY	
		Port 1/4	OG	Port 6/2	YE / BN	
		Port 2/2	VT	Port 6/4	YE	
		Port 2/4	RD / BI	Port 7/2	GY / PK	
		Port 3/2	GY / BN	Port 7/4	WH / GN	
8 port J-box, 2 signals per port, snap lock port connectors, integral M16 homerun cordset	2 A / signal, 3 A total 19-pin M16 cordset Black PVC cable Mates with BKM 19-995.*	<u>Function</u>	<u>Pin / Color</u>	<u>Function</u>	<u>Pin / Color</u>	TB-8M8Z-4.*-BSM19
		+V	L/BN	Port 4/4	P/WH	
		- V	A/BU	Port 5/2	G/PK	
		Port 1/2	R/RD	Port 5/4	S/GY	
		Port 1/4	M/OG	Port 6/2	K/YE/BN	
		Port 2/2	O/VT	Port 6/4	T/YE	
		Port 2/4	C/RD/BU	Port 7/2	B/GY/PK	
		Port 3/2	N/GY/BN	Port 7/4	D/WH/GN	
Port 3/4	U/TN	Port 8/2	H/WH/YE			
Port 4/2	E/BK	Port 8/4	I/GN			

8-Port, 4-pin, Threaded, 10-48 VDC

Application	Specifications	Homerun Pinout				No LEDs
8 port J-box, 2 signals per port, threaded port connectors, integral homerun cable	2 A / signal, 6 A total Black PVC cable 19x22 AWG	<u>Function</u>	<u>Color</u>	<u>Function</u>	<u>Color</u>	TB-8M8M-4.*
		- V	BU	Port 4/4	WH	
		+V	BN	Port 5/2	PK	
		Port 1/2	RD	Port 5/4	GY	
		Port 1/4	OG	Port 6/2	YE / BN	
		Port 2/2	VT	Port 6/4	YE	
		Port 2/4	RD / BI	Port 7/2	GY / PK	
		Port 3/2	GY / BN	Port 7/4	WH / GN	
8 port J-box, 2 signals per port, threaded port connectors, integral M16 homerun cordset	2 A / signal, 3 A total 19-pin M16 cordset Black PVC cable Mates with BKM 19-995.*	<u>Function</u>	<u>Pin / Color</u>	<u>Function</u>	<u>Pin / Color</u>	TB-8M8M-4.*-BSM19
		+V	L/BN	Port 4/4	P/WH	
		- V	A/BU	Port 5/2	G/PK	
		Port 1/2	R/RD	Port 5/4	S/GY	
		Port 1/4	M/OG	Port 6/2	K/YE/BN	
		Port 2/2	O/VT	Port 6/4	T/YE	
		Port 2/4	C/RD/BU	Port 7/2	B/GY/PK	
		Port 3/2	N/GY/BN	Port 7/4	D/WH/GN	
Port 3/4	U/TN	Port 8/2	H/WH/YE			
Port 4/2	E/BK	Port 8/4	I/GN			

We reserve the right to make technical alterations without prior notice.

Functional Wiring Diagrams

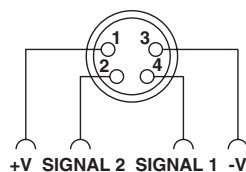

Specifications

Housing:	Nylon	Temperature:	-40 °C to +85 °C (-40 °F to +185 °F)
Connectors:	Nylon or TPU	Protection:	IEC IP67 (all) , IP68 (threaded only)
Contacts:	Gold plated brass	Accessories:	2 pieces PSGK-MC (snap lock) or PSGM-CC (threaded) and 5 pieces KS 5/10 labels included
Thread Inserts:	Nickel plated brass	Cable Length:	Standard length is nominal 5 meters Other lengths available by request - Consult factory
Cable:	See table	Recommended Splitter:	YP2-MFS 4/2MFK 3, for threaded version only

Dimensions

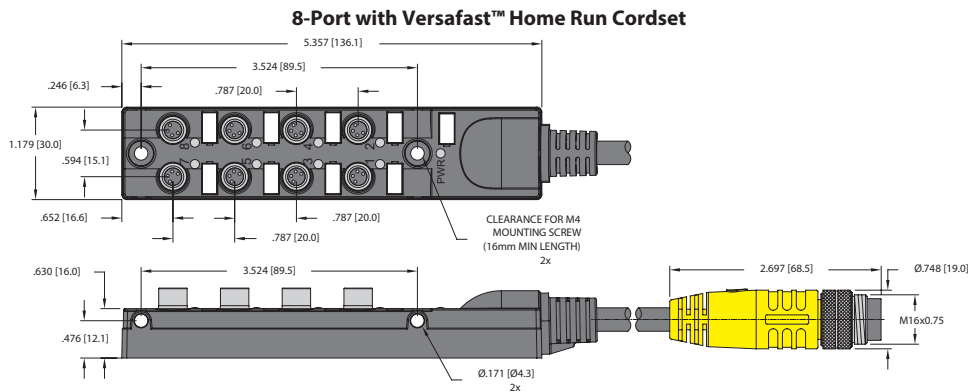
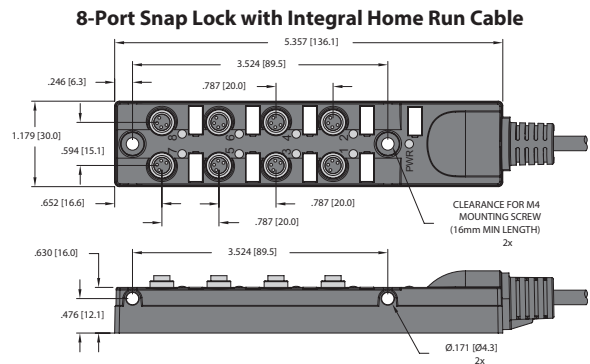
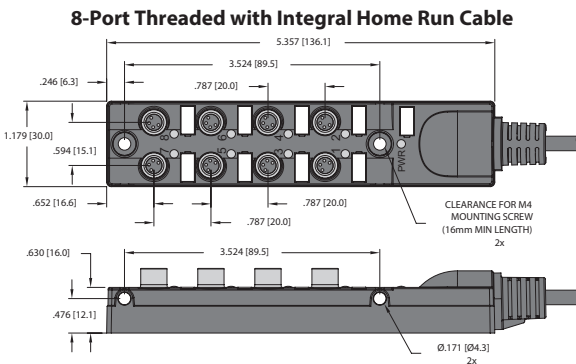

We reserve the right to make technical alterations without prior notice.

multibox®, picofast®

Pinout

4-pin Picofast	19-pin Versafast
Female	Male

Junction Box Connectivity Products

Multibox® Picofast® Junction Boxes, 10-Port

- 10 Inputs/Outputs
- M16 Quick Disconnect or Integral Home Run Cable
- For Use with 3-pin Snap Lock Picofast Cordsets
- Available with or without LEDs

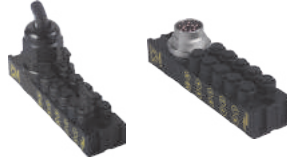

10-Port, J-box, Snap Lock, 48 VDC

Application	Specifications	Pinout				No LEDs	PNP LED
10-port J-box Standard wiring Integral cable	3 A/port, 3 A total Black PVC cable 12x24 AWG Foil shield and 26 AWG drain	<u>Function</u>	<u>Color</u>	<u>Function</u>	<u>Color</u>	VB 1003-*	VB 1003-PX10-*
		+V	BN	Port 5	TN		
		-V	BU	Port 6	WH		
		Port 1	RD	Port 7	GN		
		Port 2	BK	Port 8	YE		
Port 3	VT	Port 9	GY				
Port 4	OG	Port 10	PK				
10-port J-box Standard wiring M16 connector	3 A/port, 3 A total 14 pin connector M16 threads. Mates with BKM 14-755-* or BKWM 14-755-*	<u>Function</u>	<u>Pin / Color</u>	<u>Function</u>	<u>Pin / Color</u>	VB 1003-BS14	VB 1003-PX10-BS14
		+V	M/BN	Port 5	N/TN		
		-V	U/BU	Port 6	R/WH		
		Port 1	P/RD	Port 7	G/GN		
		Port 2	E/BK	Port 8	S/YE		
Port 3	O/VT	Port 9	J/GY				
Port 4	C/OG	Port 10	T/PK				

* Length in meters.

We reserve the right to make technical alterations without prior notice.

Functional Wiring Diagrams

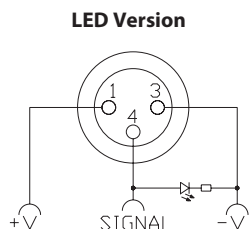
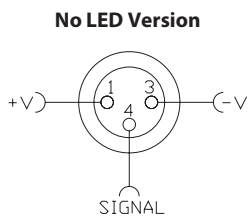

Pinout

3-pin Picofast	14-pin Versafast™
Female	Male

Specifications

Housing:	Nylon	Temperature:	-30 °C to +80 °C (-22 °F to +176 °F)
Connectors:	TPU or Nylon	Protection:	IEC IP67
Contacts:	Gold plated brass	Accessories:	Closure cap, PSG-CC (optional - 2 included)
		Cable Length:	Standard length for junction boxes and M16 cordsets is nominal 5 meters Other lengths available by request - Consult factory

Dimensions

10-Port with Integral Home Run Cable

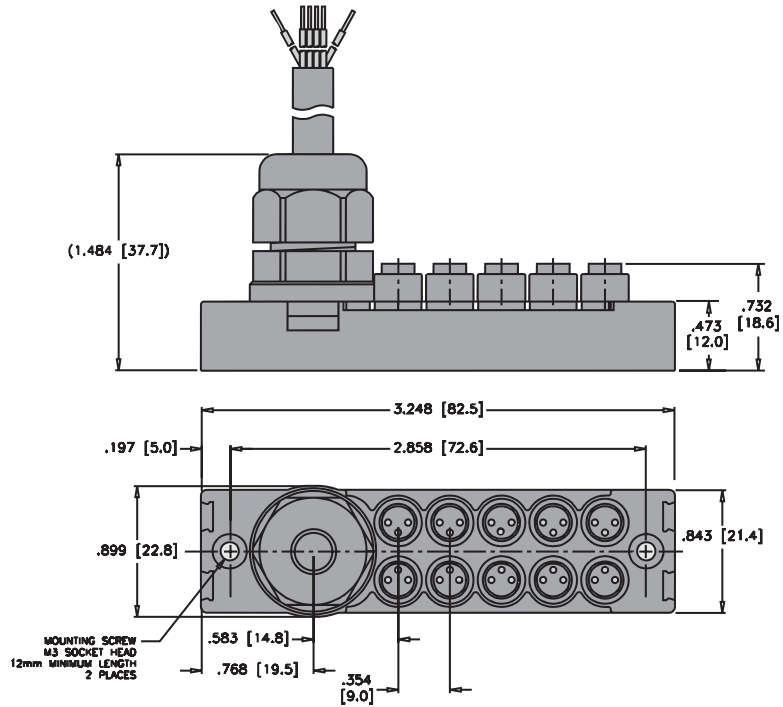

10-Port with M16 Home Run Connector

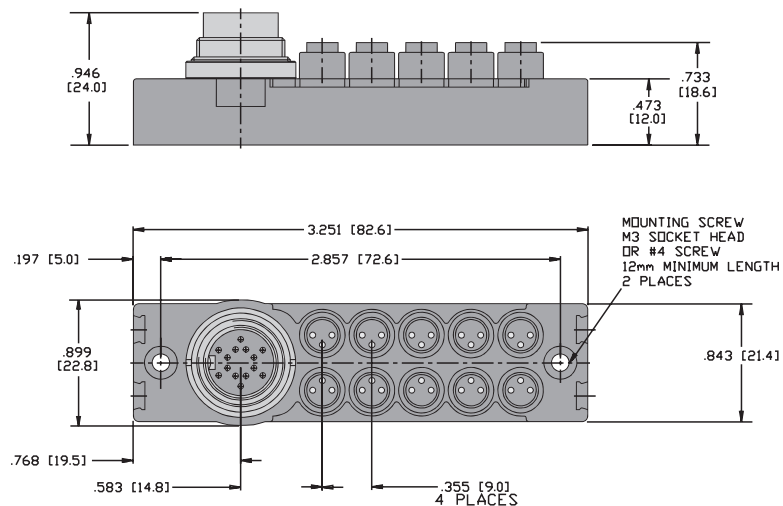

We reserve the right to make technical alterations without prior notice.

multibox®, picofast®

Junction Box Connectivity Products

Multibox® Minifast® Junction Boxes, 3-Pin

- 4, 6 and 8 Ports
- M23 Quick Disconnect, Minifast Connector or Integral Home Run Cable
- Simplifies Wiring Installations



4-Port, 250 VAC/300 VDC

Application	Specifications	Pinout				Part Number
4-port J-box Standard wiring Integral cable	4 A/port, 9 A total PVC cable, black, 6x18 AWG, foil shield and 20 AWG drain	<u>Function</u> Common (L1) Ground J1 Load (L2)	<u>Color</u> WH GN RD	<u>Function</u> J2 Load (L2) J3 Load (L2) J4 Load (L2)	<u>Color</u> OG BK BU	4 RKF 30-*M
4-port J-box Standard wiring Multifast® connector	4 A/port, 7 A total 12-pin Multifast connector, 6 conductors. Mates with CKRM 12-6-*	<u>Function</u> Common (L1) Ground J1 Load (L2)	<u>Pin / Color</u> 5 / WH 7 / GN 6 / RD	<u>Function</u> J2 Load (L2) J3 Load (L2) J4 Load (L2)	<u>Pin / Color</u> 1 / OG 4 / BK 2 / BU	4 RKF 30-CS12
4-port J-box Standard wiring Minifast connector	4 A/port, 6 A total 6-pin Minifast connector, 6 conductors. Mates with RKM 61-*M	<u>Function</u> Common (L1) Ground J1 Load (L2)	<u>Pin / Color</u> 1 / WH 3 / GN 2 / RD	<u>Function</u> J2 Load (L2) J3 Load (L2) J4 Load (L2)	<u>Pin / Color</u> 4 / OG 5 / BK 6 / BU	4 RKF 30-B1161

6-Port, 250 VAC/300 VDC

Application	Specifications	Pinout				Part Number
6-port J-box Standard wiring Integral cable	4 A/port, 9 A total PVC cable, black, 8x18 AWG, foil shield and 20 AWG drain	<u>Function</u> Common (L1) Ground J1 Load (L2) J2 Load (L2)	<u>Color</u> WH GN RD OG	<u>Function</u> J3 Load (L2) J4 Load (L2) J5 Load (L2) J6 Load (L2)	<u>Color</u> BK BU YE BN	6 RKF 30-*M
6-port J-box Standard wiring Multifast connector	4 A/port, 7 A total 12-pin Multifast connector, 8 conductors. Mates with CKRM 12-8-*	<u>Function</u> Common (L1) Ground J1 Load (L2) J2 Load (L2)	<u>Pin / Color</u> 5 / WH 7 / GN 6 / RD 1 / OG	<u>Function</u> J3 Load (L2) J4 Load (L2) J5 Load (L2) J6 Load (L2)	<u>Pin / Color</u> 4 / BK 2 / BU 3 / YE 8 / BN	6 RKF 30-CS12

8-Port, 250 VAC/300 VDC

Application	Specifications	Pinout				Part Number
8-port J-box Standard wiring Integral cable	4 A/port, 9 A total PVC cable, black, 10x18 AWG, foil shield and 20 AWG drain	<u>Function</u> Common (L1) Ground J1 Load (L2) J2 Load (L2) J3 Load (L2)	<u>Color</u> WH GN RD VT BK	<u>Function</u> J4 Load (L2) J5 Load (L2) J6 Load (L2) J7 Load (L2) J8 Load (L2)	<u>Color</u> BU GY YE OG BN	8 RKF 30-*M
8-port J-box Standard wiring Multifast connector	4 A/port, 7 A total 12-pin Multifast connector, 10 conductors. Mates with CKRM 12-10-*	<u>Function</u> Common (L1) Ground J1 Load (L2) J2 Load (L2) J3 Load (L2)	<u>Pin / Color</u> 5 / WH 7 / GN 6 / RD 1 / VT 4 / BK	<u>Function</u> J4 Load (L2) J5 Load (L2) J6 Load (L2) J7 Load (L2) J8 Load (L2)	<u>Pin / Color</u> 2 / BU 3 / GY 8 / YE 9 / OG 10 / BN	8 RKF 30-CS12

* Length in meters.

We reserve the right to make technical alterations without prior notice.

Specifications

Housing: Die cast aluminum alloy	Temperature: -40 °C to +90 °C (-40 °F to +194 °F)
Connectors: Nickel plated brass, oil resistant TPU contact carrier	Protection Class: IEC IP67
Contacts: Gold plated brass	Cable Length: Standard cable length is 6 meters. Other lengths available by request - consult factory
Cable: See table for specifications	

Dimensions

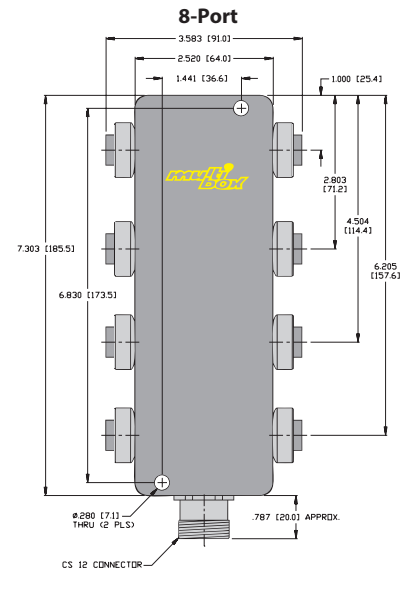
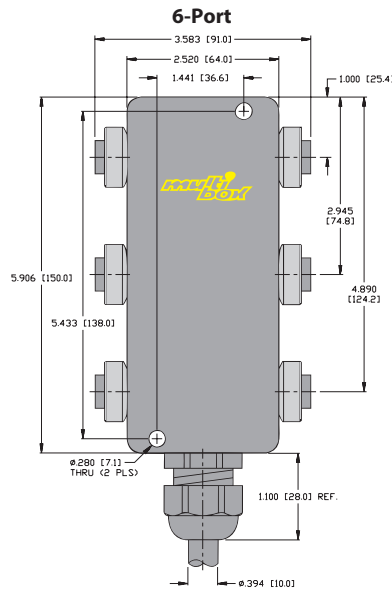
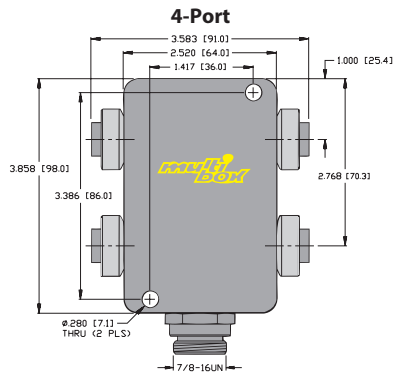

We reserve the right to make technical alterations without prior notice.

Notes

Clearance holes for 1/4-20 screws (2 places).
All housings are 34 mm in height.

Pinout

3-pin Minifast	6-pin Minifast	12-pin Multifast®
Female	Male	Male

Wiring Diagrams

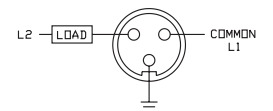

Load (L2) is individual output. Common (L1) and Ground are wired parallel internally.

multibox®, minifast®

Junction Box Connectivity Products

Multibox® Minifast® Junction Boxes, 3-pin

- 6 and 8 Ports
- Quick Disconnect Minifast Connector
- Simplifies Wiring Installations



6-Port, 250 VAC / 300 VDC

Application	Specifications	Pinout				Part Number
6-port J-box Standard wiring, Minifast connector	4 A/port 8 A total 8-pin Minifast connector 8 conductors. Mates with RKM 86-*M	<u>Function</u> Common (L1) Ground J1 Load (L2) J2 Load (L2)	<u>Pin / Color</u> 5 / WH 7 / GN 6 / RD 1 / OG	<u>Function</u> J3 Load (L2) J4 Load (L2) J5 Load (L2) J6 Load (L2)	<u>Pin / Color</u> 4 / BK 2 / BU 3 / WH / BK 8 / RD / BK	6 RKF 30-RSF80

8-Port, 250 VAC / 300 VDC

Application	Specifications	Pinout				Part Number
8-port J-box Standard wiring, Minifast connector	4 A/port 7 A total 10-pin Minifast connector 10 conductors. Mates with RKM 106-*M	<u>Function</u> Common (L1) Ground J1 Load (L2) J2 Load (L2) J3 Load (L2)	<u>Pin / Color</u> 10 / WH 8 / GN 7 / RD 1 / OG 9 / BK	<u>Function</u> J4 Load (L2) J5 Load (L2) J6 Load (L2) J7 Load (L2) J8 Load (L2)	<u>Pin / Color</u> 2 / BU 3 / WH / BK 4 / RD / BK 5 / GN / BK 6 / OG / BK	8 RKF 30-RSF100

We reserve the right to make technical alterations without prior notice.

Functional Wiring Diagrams

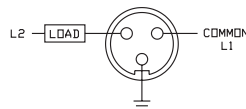

Specifications

Housing:	Die cast aluminum alloy	Temperature:	-30 °C to +80 °C (-22 °F to +176 °F)
Connectors:	Nickel plated brass, oil resistant TPU contact carrier	Protection:	IEC IP67
Contacts:	Gold plated brass		

Dimensions

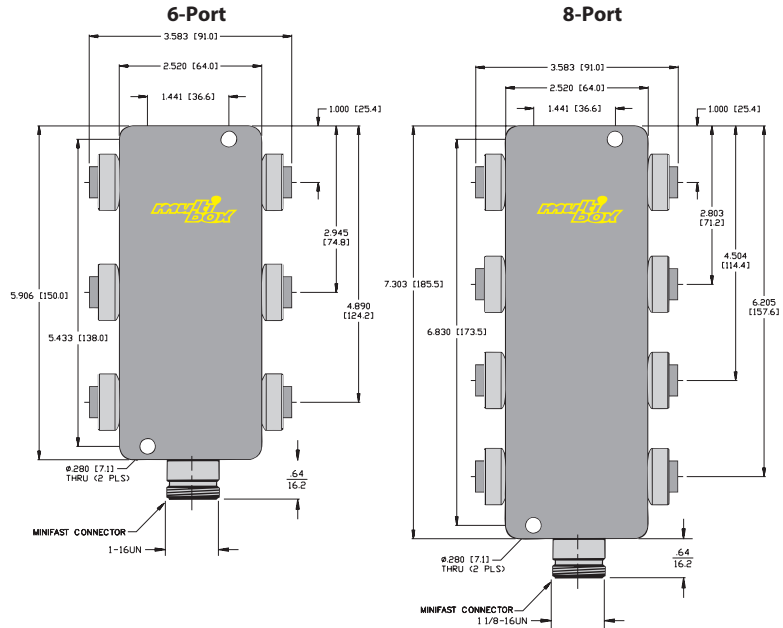

We reserve the right to make technical alterations without prior notice.

multibox®, minifast®

Notes

Clearance holes for 1/4-20 screws (2 places).
All housings are 34 mm in height.

Pinout

3-pin Minifast	8-pin Minifast	10-pin Minifast
Female	Male	Male

Junction Box Connectivity Products

Multibox® Minifast® Junction Boxes with LEDs, 3-pin

- 4 and 8 Ports
- M23 Quick Disconnect or Integral Home Run Cable
- Simplifies Wiring Installations
- LEDs for Power and Signal



4-Port, 40-120 VAC

Application	Specifications	Pinout				Part Number
4 port J-box Standard wiring Integral cable	4 A/port, 9 A total PVC cable, black, 7x18 AWG, foil shield and 20 AWG drain	<u>Function</u> Common (L1) LED Power (L2) Ground J1 Load (L2)	<u>Color</u> WH WH / BK GN RD	<u>Function</u> J2 Load (L2) J3 Load (L2) J4 Load (L2)	<u>Color</u> OG BK BU	4 RKF 30-X5-*M
4 port J-box Standard wiring Multifast connector	4 A/port, 7 A total 12-pin Multifast connector, 7 conductors. Mates with CKBM 12-7-*	<u>Function</u> Common (L1) LED Power (L2) Ground J1 Load (L2)	<u>Pin / Color</u> 3 / WH 1 / WH/BK 7 / GN 4 / RD	<u>Function</u> J2 Load (L2) J3 Load (L2) J4 Load (L2)	<u>Pin / Color</u> 5 / OG 2 / BK 6 / BU	4 RKF 30-X5-CS12

8-Port, 40-120 VAC

Application	Specifications	Pinout				Part Number
8 port J-box Standard wiring Integral cable	4 A/port, 9 A total PVC cable, black, 11x18 AWG, foil shield and 20 AWG drain	<u>Function</u> Common (L1) LED Power (L2) Ground J1 Load (L2) J2 Load (L2) J3 Load (L2)	<u>Color</u> WH BU / BK GN RD OG BK	<u>Function</u> J4 Load (L2) J5 Load (L2) J6 Load (L2) J7 Load (L2) J8 Load (L2)	<u>Color</u> BU WH / BK RD / BK GN / BK OG / BK	8 RKF 30-X9-*M
8 port J-box, Standard wiring Multifast connector	4 A/port, 7 A total 12-pin Multifast connector, 11 conductors. Mates with CKBM 12-11-*	<u>Function</u> Common (L1) LED Power (L2) Ground J1 Load (L2) J2 Load (L2) J3 Load (L2)	<u>Pin / Color</u> 11 / WH 7 / BU/BK 9 / GN 10 / RD 1 / OG 12 / BK	<u>Function</u> J4 Load (L2) J5 Load (L2) J6 Load (L2) J7 Load (L2) J8 Load (L2)	<u>Pin / Color</u> 2 / BU 3 / WH / BK 4 / RD / BK 5 / GN / BK 6 / OG / BK	8 RKF 30-X9-CS12

* Length in meters.

We reserve the right to make technical alterations without prior notice.

Functional Wiring Diagrams

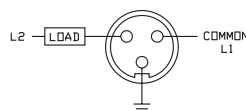

Specifications

Housing:	Die cast aluminum alloy	Temperature:	-30 °C to +80 °C (-22 °F to +176 °F)
Connectors:	Nickel plated brass, oil resistant TPU contact carrier	Protection Class:	IEC IP67
Contacts:	Gold plated brass	Cable Length:	Standard cable length is 6 meters. Other lengths available by request - consult factory
Cable:	See table for specifications		

Dimensions

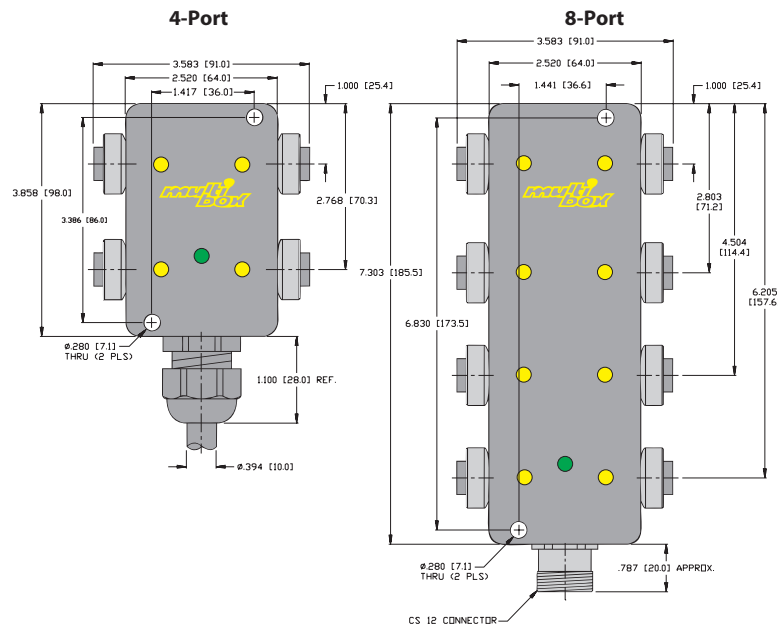

We reserve the right to make technical alterations without prior notice.

multibox®, minifast®

Notes

- Clearance holes for 1/4-20 screws (2 places).
- All housings are 34 mm in height.
- Green LED = Power on (center position)
- Yellow LED = Signal (outer position).

Pinout

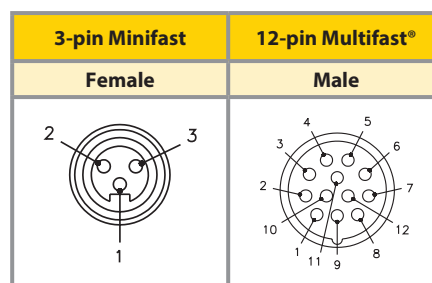

Junction Box Connectivity Products

Multibox® Minifast® Junction Boxes with LEDs, 3-pin

- 4 and 8 Ports
- Quick Disconnect Minifast Connector
- Simplifies Wiring Installations
- LEDs for Power and Signal



4-Port, 40-120 VAC

Application	Specifications	Pinout				Part Number
4-port J-box Standard wiring, Minifast connector	4 A/port	<u>Function</u>	<u>Color</u>	<u>Function</u>	<u>Color</u>	4 RKF 30-X5-RSF70
	8 A total	Common (L1)	3 / WH	J2 Load (L2)	5 / OG	
	7-pin Minifast connector	LED Pwr (L2)	1 / WH / BK	J3 Load (L2)	2 / BK	
	7 conductors. Mates with RKM 76-*M	Ground	7 / GN	J4 Load (L2)	6 / BU	
		J1 Load (L2)	4 / RD			

8-Port, 40-120 VAC

Application	Specifications	Pinout				Part Number
8-port J-box Standard wiring, Minifast connector	4 A/port	<u>Function</u>	<u>Color</u>	<u>Function</u>	<u>Color</u>	8 RKF 30-X9-RSF120
	7 A total	Common (L1)	11 / WH	J4 Load (L2)	2 / BU	
	12-pin Minifast connector	LED Pwr (L27)	1 / BU / BK	J5 Load (L2)	3 / WH / BK	
	11 conductors. Mates with RKM 126-*M	Ground	9 / GN	J6 Load (L2)	4 / RD / BK	
		J1 Load (L2)	10 / RD	J7 Load (L2)	5 / GN / BK	
		J2 Load (L2)	1 / OG	J8 Load (L2)	6 / OG / BK	
		J3 Load (L2)	12 / BK			

We reserve the right to make technical alterations without prior notice.

Functional Wiring Diagrams

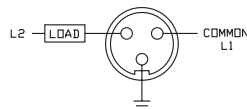

Specifications

Housing:	Die cast aluminum alloy	Temperature:	-30 °C to +80 °C (-22 °F to +176 °F)
Connectors:	Nickel plated brass, oil resistant TPU contact carrier	Protection:	IEC IP67
Contacts:	Gold plated brass		

Dimensions

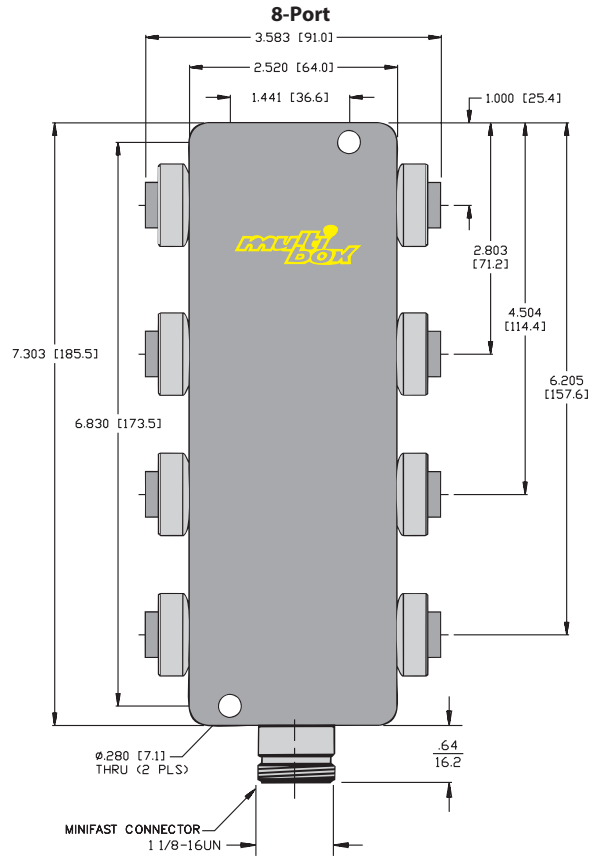
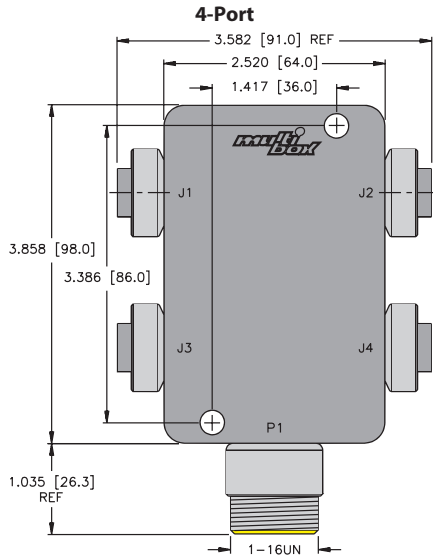

We reserve the right to make technical alterations without prior notice.

multibox®, minifast®

Notes

- Clearance holes for 1/4-20 screws (2 places).
- All housings are 34 mm in height.

Pinout

3-pin Minifast	7-pin Minifast	12-pin Minifast
Female	Male	Male

Junction Box Connectivity Products

Multibox® Minifast® Junction Boxes, 4-pin

- 4, 6 and 8 Ports
- Integral Home Run Cable
- Simplifies Wiring Installations



4-Port, 250 VAC/300 VDC

Application	Specifications	Pinout				Part Number
4-port J-box, 4-pin connectors, Integral cable	4 A/port, 9 A total PVC cable, black, 6x18 AWG, foil shield and 20 AWG drain	<u>Function</u>	<u>Color</u>	<u>Function</u>	<u>Color</u>	4 RKF 40-*M
		Common +V	WH	J2 Load	OG	
		Ground -V	GN	J3 Load	BK	
		J1 Load	RD	J4 Load	BU	

6-Port, 250 VAC/300 VDC

Application	Specifications	Pinout				Part Number
6-port J-box, 4-pin connectors, Integral cable	4 A/port, 9 A total PVC cable, black, 8x18 AWG, foil shield and 20 AWG drain	<u>Function</u>	<u>Color</u>	<u>Function</u>	<u>Color</u>	6 RKF 40-*M
		Common +V	WH	J3 Load	BK	
		Ground -V	GN	J4 Load	BU	
		J1 Load	RD	J5 Load	YE	
		J2 Load	OG	J6 Load	BN	

8-Port, 250 VAC/300 VDC

Application	Specifications	Pinout				Part Number
8-port J-box, 4-pin connectors, Integral cable	4 A/port, 9 A total PVC cable, black, 10x18 AWG, foil shield and 20 AWG drain	<u>Function</u>	<u>Color</u>	<u>Function</u>	<u>Color</u>	8 RKF 40-*M
		Common +V	WH	J4 Load	BU	
		Ground -V	GN	J5 Load	GY	
		J1 Load	RD	J6 Load	YE	
		J2 Load	VT	J7 Load	OG	
		J3 Load	BK	J8 Load	BN	

We reserve the right to make technical alterations without prior notice.

Functional Wiring Diagrams



Power (pin 1 and pin 3) are wired parallel internally.
Load (pin 4) is individual output. Pin 2 is not used.

Multibox® Minifast® Junction Boxes, 4-pin

Specifications

Housing:	Die cast aluminum alloy	Temperature:	-30 °C to +80 °C (-22 °F to +176 °F)
Connectors:	Nickel plated brass, oil resistant TPU contact carrier	Protection Class:	IEC IP67
Contacts:	Gold plated brass	Cable Length:	Standard cable length is 6 meters. Other lengths available by request - consult factory
Cable:	See table for specifications		

Dimensions

We reserve the right to make technical alterations without prior notice.

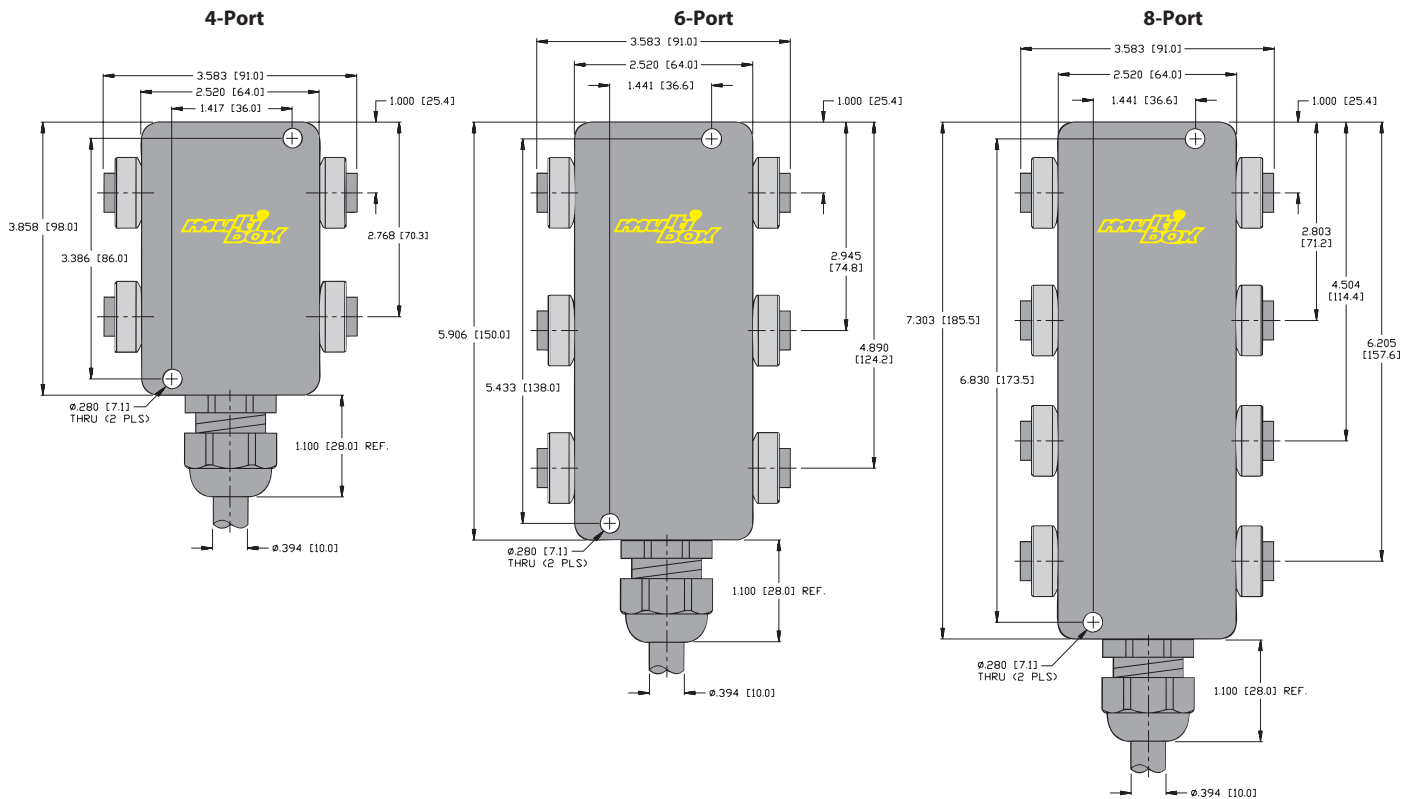

multibox®, minifast®

Notes

Clearance holes for 1/4-20 screws (2 places).
All housings are 34 mm in height.

Pinout

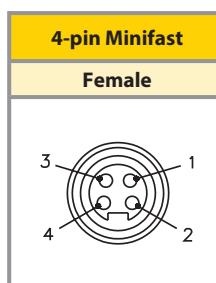

Junction Box Connectivity Products

Multibox® Minifast® Junction Boxes, 4-pin

- 4, 6 and 8 Ports
- Quick Disconnect Minifast Connector
- Simplifies Wiring Installations



4-Port, 250 VAC / 300 VDC

Application	Specifications	Pinout				Part Number
4-port J-box 4-pin connectors, Minifast connector	4 A/port 8 A total 6-pin Minifast connector 6 conductors. Mates with RKM 66-*M	<u>Function</u> Common +V Ground -V J1 Load	<u>Pin/Color</u> 1 / WH 3 / GN 2 / RD	<u>Function</u> J2 Load J3 Load J4 Load	<u>Pin/Color</u> 4 / OG 5 / BK 6 / BU	4 RKF 40-RSF6B6

6-Port, 250 VAC / 300 VDC

Application	Specifications	Pinout				Part Number
6-port J-box 4-pin connectors, Minifast connector	4 A/port 8 A total 8-pin Minifast connector 8 conductors. Mates with RKM 86-*M	<u>Function</u> Common +V Ground -V J1 Load J2 Load	<u>Pin/Color</u> 5 / WH 7 / GN 6 / RD 1 / OG	<u>Function</u> J3 Load J4 Load J5 Load J6 Load	<u>Pin/Color</u> 4 / BK 2 / BU 3 / WH / BK 8 / RD / BK	6 RKF 40-RSF80

8-Port, 250 VAC / 300 VDC

Application	Specifications	Pinout				Part Number
8-port J-box 4-pin connectors, Minifast connector	4 A/port 7 A total 10-pin Minifast connector 10 conductors. Mates with RKM 106-*M	<u>Function</u> Common +V Ground -V J1 Load J2 Load J3 Load	<u>Pin/Color</u> 10 / WH 8 / GN 7 / RD 1 / OG 9 / BK	<u>Function</u> J4 Load (L2) J5 Load (L2) J6 Load (L2) J7 Load (L2) J8 Load (L2)	<u>Pin/Color</u> 2 / BU 3 / WH / BK 4 / RD / BK 5 / GN / BK 6 / OG / BK	8 RKF 40-RSF100

We reserve the right to make technical alterations without prior notice.

Functional Wiring Diagrams



Power (pin 1 and pin 3) are wired parallel internally.
Load (pin 4) is individual output. Pin 2 is not used.

Specifications

Housing:	Die cast aluminum alloy	Temperature:	-30 °C to +80 °C (-22 °F to +176 °F)
Connectors:	Nickel plated brass, oil resistant TPU contact carrier	Protection:	IEC IP67
Contacts:	Gold plated brass		

Dimensions

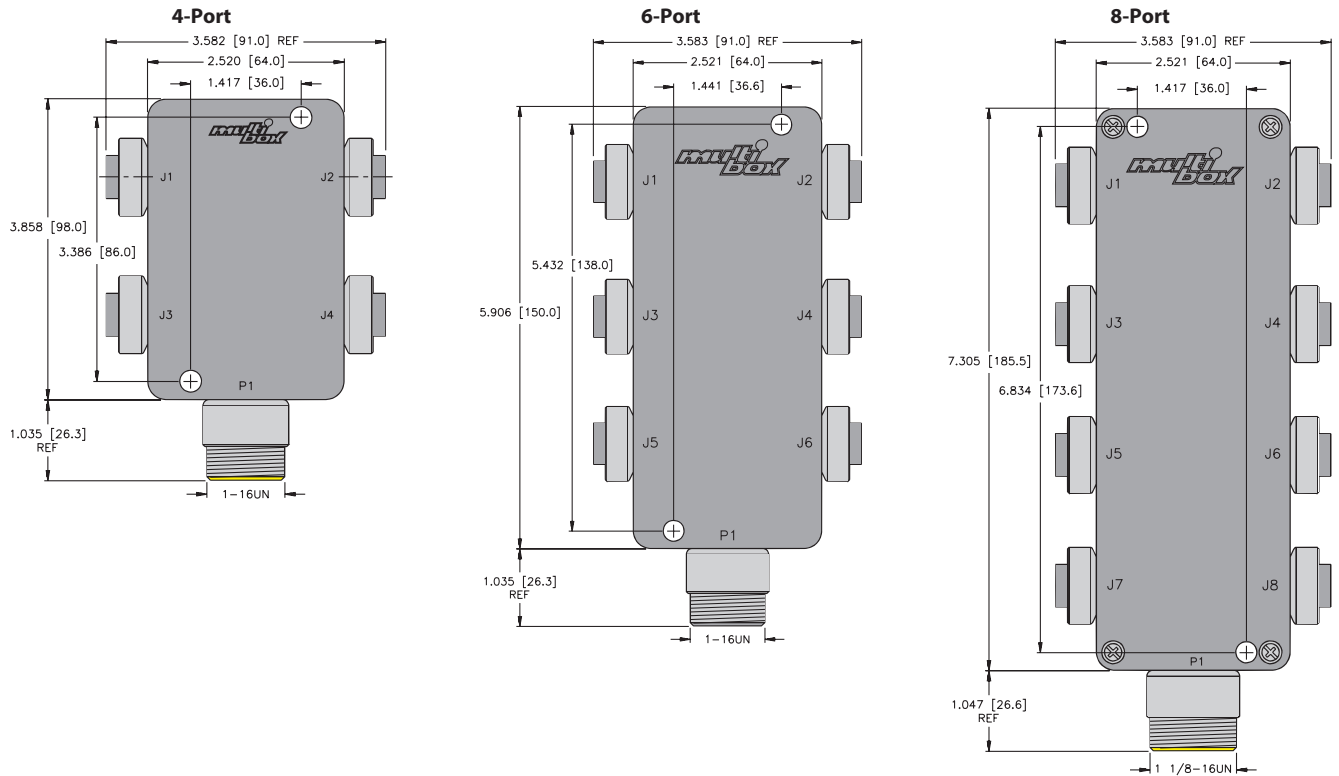

We reserve the right to make technical alterations without prior notice.

multibox®, minifast®

Notes

Clearance holes for 1/4-20 screws (2 places).
All housings are 34 mm in height.

Pinout

4-pin Minifast	6-pin Minifast	8-pin Minifast	10-pin Minifast
Female	Male	Male	Male

Junction Box Connectivity Products

Multibox® Minifast® Junction Boxes, Series Wired

- 4, 6 and 8 Ports
- Minifast Quick Disconnect or Integral Home Run Cable
- Simplifies Wiring Installations
- Series Wired for Logic Wiring and or NOR Junction



4-Port, 250 VAC/300 VDC

Application	Specifications	Pinout		Part Number
4 port J-box Series wired Integral cable	4 A/port, 4 A total PVC cable, yellow, 3/16 AWG	<u>Function</u> Common (L1) Ground Load (L2)	<u>Color</u> WH GN BK	4 RKF 301-*M
4 port J-box Series wired Minifast connector	4 A/port, 4 A total 3-pin Minifast connector, 3 conductors. Mates with RKM 36-*M	<u>Function</u> Common (L1) Ground Load (L2)	<u>Pin/Color</u> 3 / WH 1 / GN 2 / BK	4 RKF 301-B1131

6-Port, 250 VAC/300 VDC

Application	Specifications	Pinout		Part Number
6 port J-box Series wired Integral cable	4 A/port, 4 A total PVC cable, yellow, 3/16 AWG	<u>Function</u> Common (L1) Ground Load (L2)	<u>Color</u> WH GN BK	6 RKF 301-*M
6 port J-box Series wired Minifast connector	4 A/port, 4 A total 3-pin Minifast connector, 3 conductors. Mates with RKM 36-*M	<u>Function</u> Common (L1) Ground Load (L2)	<u>Pin/Color</u> 3 / WH 1 / GN 2 / BK	6 RKF 301-B1131

8-Port, 250 VAC/300 VDC

Application	Specifications	Pinout		Part Number
8 port J-box Series wired Integral cable	4 A/port, 4 A total PVC cable, yellow, 3x16 AWG	<u>Function</u> Common (L1) Ground Load (L2)	<u>Color</u> WH GN BK	8 RKF 301-*M
8 port J-box Series wired Minifast connector	4 A/port, 4 A total 3-pin Minifast connector, 3 conductors. Mates with RKM 36-*M	<u>Function</u> Common (L1) Ground Load (L2)	<u>Pin/Color</u> 3 / WH 1 / GN 2 / BK	8 RKF 301-B1131

We reserve the right to make technical alterations without prior notice.

Housing Style	Part Number	Features	Pinout
	RSM 30-J23	Jumper plug for use on unused inputs	

Functional Wiring Diagrams

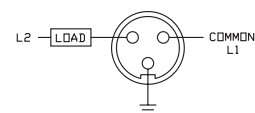

Specifications

Housing:	Die cast aluminum alloy	Temperature:	-30 °C to +80 °C (-22 °F to +176 °F)
Connectors:	Nickel plated brass, oil resistant TPU contact carrier	Protection:	IEC IP67
Contacts:	Gold plated brass	Cable Length:	Standard cable length is 6 meters. Other lengths available by request - consult factory
Cable:	See table for specifications		

Dimensions

We reserve the right to make technical alterations without prior notice.

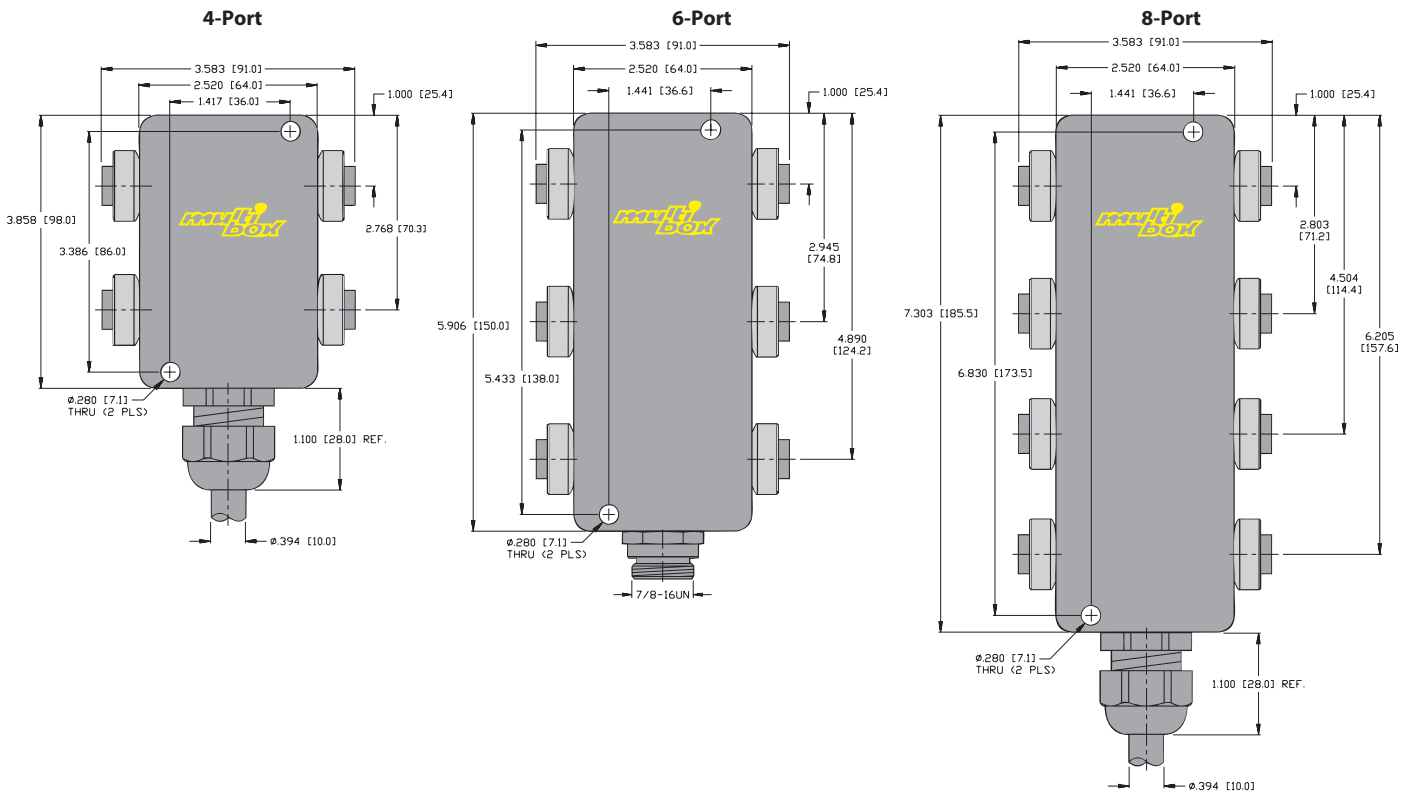

multibox®, minifast®

Notes

Clearance holes for 1/4-20 screws (2 places).
 All housings are 34 mm in height.

Pinout

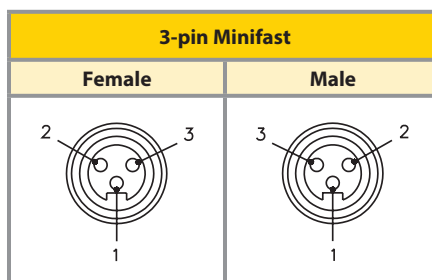

Junction Box Connectivity Products

Multibox® Microfast® Junction Boxes

- 4, 6 and 8 Ports
- For AC Sensors
- M23 Quick Disconnect, Minifast® Connector or Integral Home Run Cable
- Simplifies Wiring Installations



4-Port, 250 VAC / 300 VDC

Application	Specifications	Pinout				Part Number
4-port J-box Standard wiring Integral cable	4 A/port, 9 A total PVC cable, black, 6x18 AWG, foil shield and 20 AWG drain	<u>Function</u> Common (L1) Ground J1 Load (L2)	<u>Color</u> WH GN RD	<u>Function</u> J2 Load (L2) J3 Load (L2) J4 Load (L2)	<u>Color</u> OG BK BU	VBKB 40-*
4-port J-box Standard wiring, Multifast® connector	4 A/port, 7 A total 12-pin Multifast connector, 6 conductors. Mates with CKRM 12-6-*	<u>Function</u> Common (L1) Ground J1 Load (L2)	<u>Pin/Color</u> 5 / WH 7 / GN 6 / RD	<u>Function</u> J2 Load (L2) J3 Load (L2) J4 Load (L2)	<u>Pin/Color</u> 1 / OG 4 / BK 2 / BU	VBKB 40-CS12
4-port J-box Standard wiring Minifast connector	4 A/port, 9 A total 6-pin Minifast connector, 6 conductors. Mates with RKM 66-*M	<u>Function</u> Common (L1) Ground J1 Load (L2)	<u>Pin/Color</u> 1 / WH 3 / GN 2 / RD	<u>Function</u> J2 Load (L2) J3 Load (L2) J4 Load (L2)	<u>Pin/Color</u> 4 / OG 5 / BK 6 / BU	VBKB 40-B1161

6-Port, 250 VAC / 300 VDC

Application	Specifications	Pinout				Part Number
6-port J-box Standard wiring Integral cable	4 A/port, 9 A total PVC cable, black, 8x18 AWG, foil shield and 20 AWG drain	<u>Function</u> Common (L1) Ground J1 Load (L2) J2 Load (L2)	<u>Color</u> WH GN RD OG	<u>Function</u> J3 Load (L2) J4 Load (L2) J5 Load (L2) J6 Load (L2)	<u>Color</u> BK BU YE BN	VBKB 60-*
6-port J-box Standard wiring Multifast connector	4 A/port, 7 A total 12-pin Multifast connector, 8 conductors. Mates with CKRM 12-8-*	<u>Function</u> Common (L1) Ground J1 Load (L2) J2 Load (L2)	<u>Pin/Color</u> 5 / WH 7 / GN 6 / RD 1 / OG	<u>Function</u> J3 Load (L2) J4 Load (L2) J5 Load (L2) J6 Load (L2)	<u>Pin/Color</u> 4 / BK 2 / BU 3 / YE 8 / BN	VBKB 60-CS12

8-Port, 250 VAC / 300 VDC

Application	Specifications	Pinout				Part Number
8-port J-box Standard wiring, Integral cable	4 A/port, 9 A total PVC cable, black, 10x18 AWG, foil shield and 20 AWG drain	<u>Function</u> Common (L1) Ground J1 Load (L2) J2 Load (L2) J3 Load (L2)	<u>Color</u> WH GN RD VT BK	<u>Function</u> J4 Load (L2) J5 Load (L2) J6 Load (L2) J7 Load (L2) J8 Load (L2)	<u>Color</u> BU GY YE OG BN	VBKB 80-*
8-port J-box Standard wiring Multifast connector	4 A/port, 7 A total 12-pin Multifast connector, 10 conductors. Mates with CKRM 12-10-*	<u>Function</u> Common (L1) Ground J1 Load (L2) J2 Load (L2) J3 Load (L2)	<u>Pin/Color</u> 5 / WH 7 / GN 6 / RD 1 / VT 4 / BK	<u>Function</u> J4 Load (L2) J5 Load (L2) J6 Load (L2) J7 Load (L2) J8 Load (L2)	<u>Pin/Color</u> 2 / BU 3 / GY 8 / YE 9 / OG 10 / BN	VBKB 80-CS12

* Length in meters.

We reserve the right to make technical alterations without prior notice.

Multibox® Microfast® Junction Boxes

Specifications

Housing:	Nylon	Temperature:	-30 °C to +80 °C (-22 °F to +176 °F)
Connectors:	Nylon (Microfast)	Protection:	IEC IP67
Contacts:	Gold plated brass	Cable Length:	Standard cable length is nominal 5 meters. Other lengths available by request - consult factory
Thread Inserts:	Nickel plated brass	Accessories:	(2) SB-CC closure caps and a VZ1 label kit included
Cable:	See table		

Dimensions

We reserve the right to make technical alterations without prior notice.

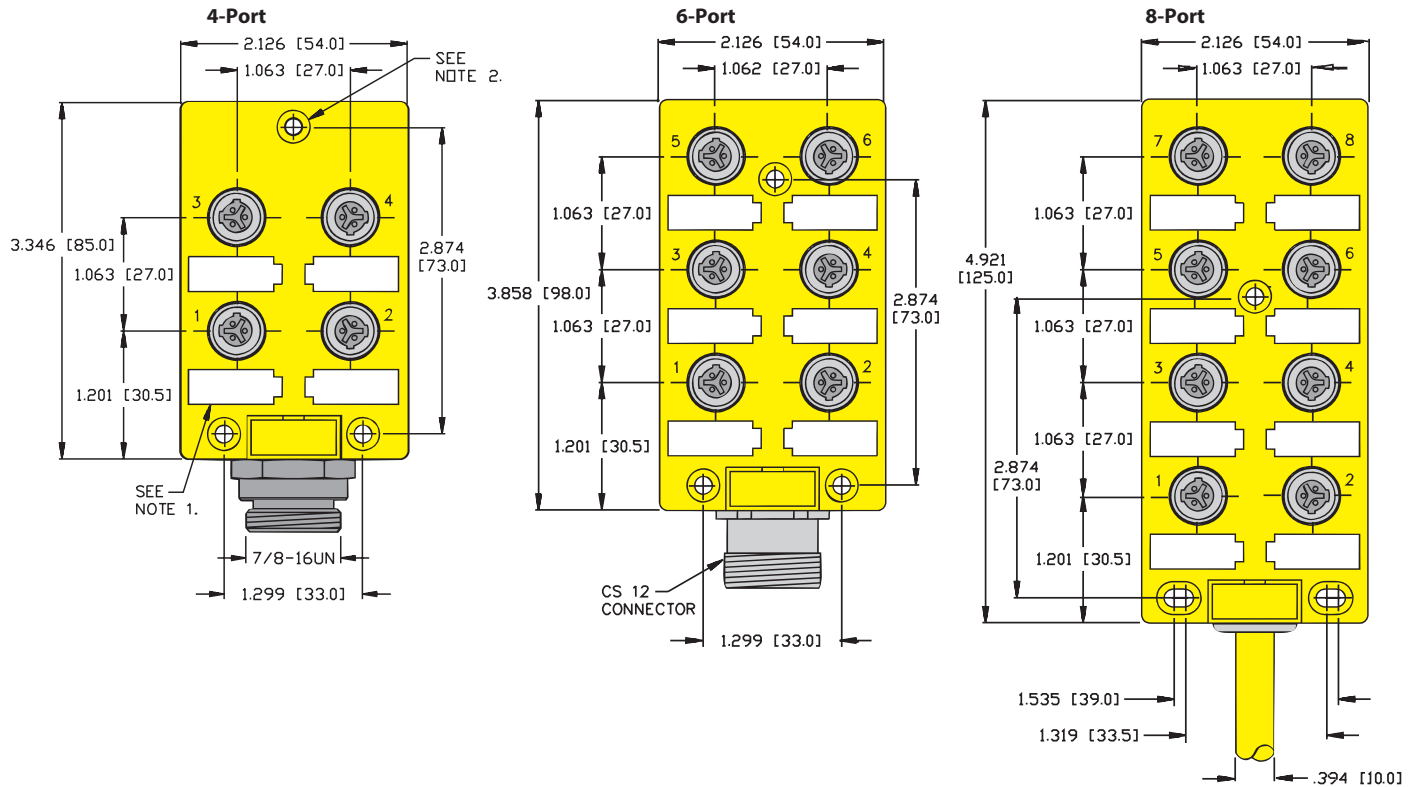

multibox®, microfast®

Notes

- Removable labels included.
- Clearance holes for #8 screws (3 places).
- Housings with integral cable: 23 mm in thickness.
- Housings with quick disconnect: 33 mm thickness.

Pinout

3-pin Microfast	6-pin Minifast®	12-pin Multifast®
Female	Male	Male

Functional Wiring Diagrams



Junction Box Connectivity Products

Multibox® Microfast® Junction Boxes with LEDs

- 4 and 8 Ports
- For AC Sensors
- Simplifies Wiring Installations
- M23 Quick Disconnect or Integral Home Run Cable
- LEDs for Power and Signal



4-Port, 40-120 VAC

Application	Specifications	Pinout				Part Number
4 port J-box Standard wiring Integral cable	4 A/port, 9 A total PVC cable, black, 7x18 AWG, foil shield and 20 AWG drain	<u>Function</u>	<u>Color</u>	<u>Function</u>	<u>Color</u>	VBKB 40-X5-*
		Common (L1)	WH	J2 Load (L2)	OG	
		LED Power (L2)	WH / BK	J3 Load (L2)	BK	
		Ground	GN	J4 Load (L2)	BU	
		J1 Load (L2)	RD			
4 port J-box Standard wiring Multifast® connector	4 A/port, 7 A total 12-pin Multifast connector, 7 conductors. Mates with CKBM 12-7-*	<u>Function</u>	<u>Pin/Color</u>	<u>Function</u>	<u>Pin/Color</u>	VBKB 40-X5-CS12v
		Common (L1)	3 / WH	J2 Load (L2)	5 / OG	
		LED Power (L2)	1 / WH/BK	J3 Load (L2)	2 / BK	
		Ground	7 / GN	J4 Load (L2)	6 / BU	
		J1 Load (L2)	4 / RD			

8-Port, 40-120 VAC

Application	Specifications	Pinout				Part Number
8 port J-box Standard wiring Integral cable	4 A/port, 9 A total PVC cable, black, 11x18 AWG, foil shield and 20 AWG drain	<u>Function</u>	<u>Color</u>	<u>Function</u>	<u>Color</u>	VBKB 80-X9-*
		Common (L1)	WH	J4 Load (L2)	BU	
		LED Power (L2)	BU / BK	J5 Load (L2)	WH / BK	
		Ground	GN	J6 Load (L2)	RD / BK	
		J1 Load (L2)	RD	J7 Load (L2)	GN / BK	
		J2 Load (L2)	OG	J8 Load (L2)	OG / BK	
		J3 Load (L2)	BK			
8 port J-box Standard wiring Multifast connector	4 A/port, 7 A total 12-pin Multifast connector, 11 conductors. Mates with CKBM 12-11-*	<u>Function</u>	<u>Pin/Color</u>	<u>Function</u>	<u>Pin/Color</u>	VBKB 80-X9-CS12
		Common (L1)	11 / WH	J4 Load (L2)	2 / BU	
		LED Power (L2)	7 / BU/BK	J5 Load (L2)	3 / WH / BK	
		Ground	9 / GN	J6 Load (L2)	4 / RD / BK	
		J1 Load (L2)	10 / RD	J7 Load (L2)	5 / GN / BK	
		J2 Load (L2)	1 / OG	J8 Load (L2)	6 / OG / BK	
		J3 Load (L2)	12 / BK			

We reserve the right to make technical alterations without prior notice.

Functional Wiring Diagrams

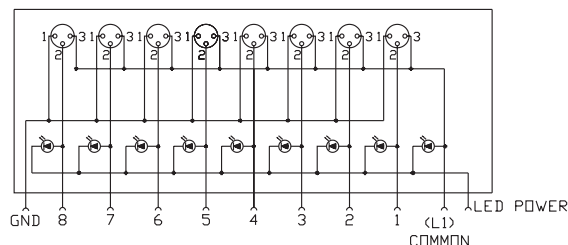
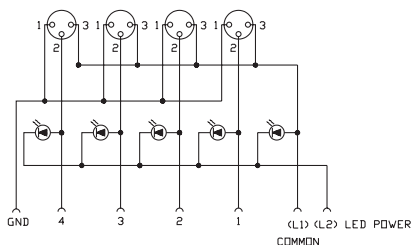

Specifications

Housing:	Nylon	Temperature:	-30 °C to +80 °C (-22 °F to +176 °F)
Connectors:	Nylon (Microfast)	Protection:	IEC IP67
Contacts:	Gold plated brass	Cable Length:	Standard cable length is nominal 5 meters. Other lengths available by request - consult factory
Thread Inserts:	Nickel plated brass	Accessories:	(2) SB-CC closure caps and a VZ1 label kit included
Cable:	See table		

Dimensions

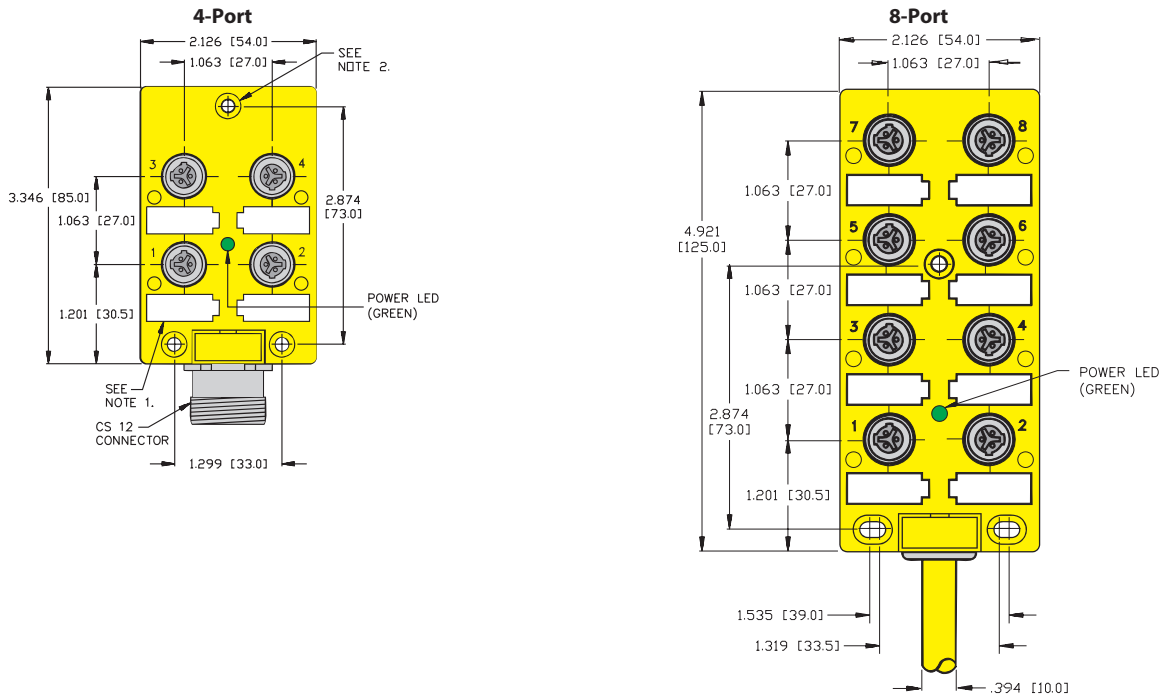

We reserve the right to make technical alterations without prior notice.

multibox®, microfast®

Notes

- Removable labels included.
- Clearance holes for #8 screws (3 places).
- Housings with integral cable: 23 mm in thickness.
- Housings with quick disconnect: 33 mm thickness.
- Green LED = Power on (center position).
- Yellow LED = Signal (outer position).

Pinout

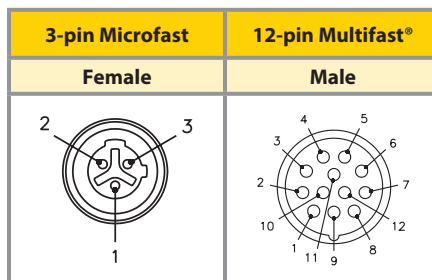

Junction Box Connectivity Products

Accessories

Drawing	Part Number	Features
	RKF-MC	Nickel plated brass, 7/8-16 UN threads, No lanyard, nitrile gasket, mates to male cordsets, receptacles, or junction box
	RKFV-MC	Stainless Steel, 7/8-16 UN threads, No lanyard, nitrile gasket, mates to male cordsets, receptacles, or junction box
	RSF-MC	Nickel plated brass, 7/8-16 UN threads, No lanyard, nitrile gasket, mates to female cordsets, receptacles, or junction box
	RSFV-MC	Stainless Steel, 7/8-16 UN threads, No lanyard, nitrile gasket, mates to female cordsets, receptacles, or junction box
	RSFK-MC	Nylon 7/8-16 UN threads, No lanyard, nitrile gasket, mates to female cordsets, receptacles, or junction box
	VZ 1	Nylon, 8 white labels, 8x20 mm each, snap-in labels for Eurofast® and Microfast® junction boxes, valve plugs
	VZ 12	Nylon, 40 white labels, 9x20 mm each, snap-in labels for Eurofast junction boxes, valve plugs

We reserve the right to make technical alterations without prior notice.

Drawing	Part Number	Features	Pinout
	RSM 30-J23	Minifast®, 7/8-16 UN thread, 300 V 80 °C, jumper plug for use on unused inputs for series wired junction boxes	

Part Number Keys	T3
Cordsets	T4
Splitters	T40
Field Wireables	T42

Features

- Environmentally protected electrical junction for use with hydraulic and pneumatic solenoid valves
- Available in A, B, I and C designs
- Options for wiring with LED, MOV or diode
- Provides rapid change out



Valve Plug Connectivity

Valve Connector Products

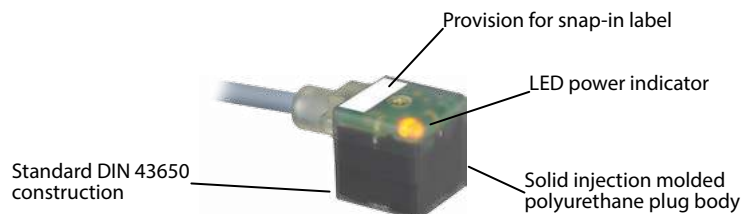

Cable Styles

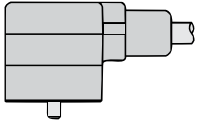
	Type "A" (18 mm) Straight Wired, Indicator LED, Indicator LED and MOV, Indicator LED and Diode - DC	T4
	Type "A" (18 mm) 3 Conductors + Ground Straight Wired, Indicator LED, Indicator LED and MOV	T10
	Type "B" (10 mm) Straight Wired, Indicator LED, Indicator LED and MOV, Indicator LED and Diode - DC	T14
	Type "I" (11 mm) Straight Wired, Indicator LED, Indicator LED and MOV, Indicator LED and Diode - DC	T20
	Type "C" (8 mm) Straight Wired, Indicator LED, Indicator LED and MOV, Indicator LED and Diode - DC	T26
	Type "C" (9.4 mm) Straight Wired, Indicator LED, Indicator LED and MOV, Indicator LED and Diode - DC	T32

Extension Styles

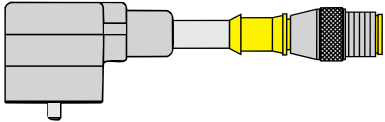
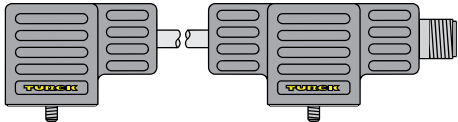
 	Type "A" (18 mm) with Eurofast®, Picofast®, Minifast® and Microfast® Connectors	T6
	Type "A" (18 mm) 3 Conductors + Ground with Eurofast Connector	T12
	Type "B" (10 mm) with Eurofast, Picofast, Minifast and Microfast Connectors	T16
	Type "I" (11 mm) with Eurofast, Picofast, Minifast and Microfast Connectors	T22
	Type "C" (8 mm) with Eurofast, Picofast, Minifast and Microfast Connectors	T28
	Type "C" (9.4 mm) with Eurofast, Minifast and Microfast Connectors	T34
Double Ended Valve Connectors - Consult factory for availability		

Integral Connector Styles

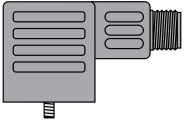
	Type "A" (18 mm) with Eurofast and Picofast Connectors	T38
	Type "B" (10 mm) and Type "I" (11 mm) with Picofast Connector	T38

2 Branch Molded Junctions with Valve Plugs

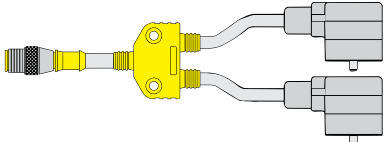
	Types "A", "B", "I" and "C"	T40
---	------------------------------------	------------

Field Wireable Styles

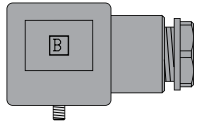
	Types "A", "B", "I" and "C"	T42
---	------------------------------------	------------

We reserve the right to make technical alterations without prior notice.

DIN 43650 Valve Cordset Part Number Key

Part Number Keys are to assist in IDENTIFICATION ONLY. Consult factory for catalog items not identified.



DIN 43650 Valve Cordset

- T = cable exit on ground side
- V = cable exit opposite ground side
- H = cable exit opposite ground side on top of plug

Housing Style

- A = type "A" (27.5 x 27.5 mm) 18 mm contact spacing
- B = type "B" (21.5 x 28 mm) 10 mm contact spacing
- I = type "I" (21.5 x 28 mm) 11 mm contact spacing
- C8 = type "C" (16 x 16 mm) 8 mm contact spacing
- C9 = type "C" (16 x 16 mm) 9.4 mm contact spacing

Housing Color

- G = Translucent grey
- S = Translucent black
- Y = Translucent yellow
- (blank) = Clear

Designator for Receptacle

- 2 = 2 conductors, 1 ground
- 21 = 2 conductors, ground not connected
- 22 = 2 conductors, 1 ground, ground contacts parallel wired
- 3 = 3 conductors, 1 ground
- 4 = 3 conductors, 1 ground, additional wire for dual LED

Varieties

- /S .. = consult factory, special
- /S810 = Longer mounting screw

Insertion Point of Extension Cable Second Prefix*

- * Valve connector listed first, other connector second
- Example: **VAS 22-F653-1M-RS 5.3T**

Connection Type / Length in Meters

- (blank) = field wireable
- FS 5.3 = integrated M12 Eurofast® connector
- V1131 = integrated M8 Picofast® connector

Number of Wires / AWG / Color Codes

- | | |
|-------------------------------|---------------------------------|
| (blank) = adapter | 644 = 4x18 AWG BN, BU, BK, WH |
| W = field wireable connector | 653 = 3x18 AWG BK, BK, GN/YE |
| 544 = 4x18 AWG BN, WH, BK, BU | 654 = 3x18 AWG BN, BU, BK |
| 587 = 3x24 AWG BN, BU, BK | 658 = 3x18 AWG RD/BK, RD/WH, GN |
| 580 = 4x18 AWG BN, WH, BK, BU | 669 = 3x18 AWG BK, BK, GN/YE |
| 642 = 3x24 AWG BN, BU, BK | |

Wiring

- A = straight through 0-220 VAC/DC
- B = yellow LED 24-48 VAC/DC
- C = yellow LED 110-220 VAC/DC
- D = yellow LED/MOV. . . . 24-48 VAC/DC
- E = yellow LED/MOV. . . . 110-220 VAC/DC
- F = yellow LED/Diode . . . 24-48 VDC
- K = two color LED for change over to switch 24 VDC
- L = yellow LED 24 VAC/DC
- M = yellow LED 48 VAC/DC
- N = yellow LED 110 VAC/DC
- P = yellow LED/MOV. . . . 24 VAC/DC
- R = yellow LED/MOV. . . . 48 VAC/DC
- red = switch open position
- green = switch closed position

Valve Plug Connectivity

Valve Connectors, Type "A" (18 mm)

- Available with PVC and TPU Jackets
- 18 and 24 AWG
- 2 Conductors + Ground, Ground Contacts Parallel Wired

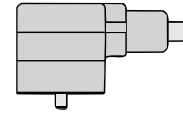

"A" Style Valve Connectors, Standard Color Code

Type A

Application	Cable Specs	Pinout	Voltage VAC/DC	Straight Wired	Indicator LED	Indicator LED and MOV**	Indicator LED and Diode - DC only
Standard duty PVC	3/18 AWG, Grey PVC 105 °C 6.2 mm OD Black Body	1. BK 1	0-220	VAS 22-A653-*M	----	----	----
		2. BK 2	24-48	----	VAS 22-B653-*M	VAS 22-D653-*M	VAS 22-F653-*M
		Gnd - GN/YE	110-220	----	VAS 22-C653-*M	VAS 22-E653-*M	----
Standard duty TPU	3/18 AWG, Grey TPU 90 °C 6.0 mm OD Black Body	1. BK 1	0-220	VAS 22-A669-*M	----	----	----
		2. BK 2	24-48	----	VAS 22-B669-*M	VAS 22-D669-*M	VAS 22-F669-*M
		Gnd - GN/YE	110-220	----	VAS 22-C669-*M	VAS 22-E669-*M	----

"A" Style Valve Connectors, IEC Color Code

Application	Cable Specs	Pinout	Voltage VAC/DC	Straight Wired	Indicator LED	Indicator LED and MOV**	Indicator LED and Diode - DC only
Small diameter PVC	3/24 AWG, Yellow PVC 105 °C 4.4 mm OD Black Body	1. BN	0-220	VAS 22-A642-*M	----	----	----
		2. BU	24-48	----	VAS 22-B642-*M	VAS 22-D642-*M	VAS 22-F642-*M
		Gnd - BK	110-220	----	VAS 22-C642-*M	VAS 22-E642-*M	----
Small diameter TPU	3/24 AWG, Black TPU 90 °C 4.2 mm OD Black Body	1. BN	0-220	VAS 22-A587-*M	----	----	----
		2. BU	24-48	----	VAS 22-B587-*M	VAS 22-D587-*M	VAS 22-F587-*M
		Gnd - BK	110-220	----	VAS 22-C587-*M	VAS 22-E587-*M	----

* Length in meters.

We reserve the right to make technical alterations without prior notice.

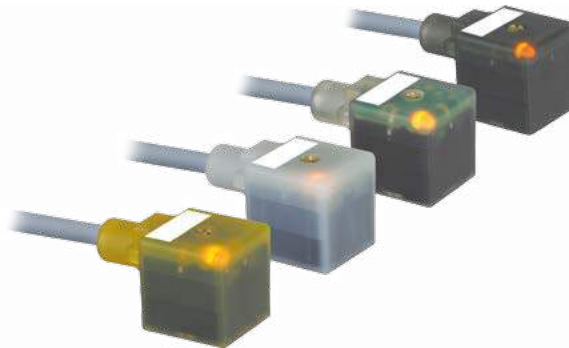

Specifications

- Connectors:** Oil resistant polyurethane body material, Nylon contact carrier.
- Contacts:** Silver plated copper alloy.
- Cable:** See table.
- Cable Length:** Standard cable lengths are nominal 2, 5 and 10 meters. Other lengths available by request - consult factory.
- Protection Class:** NEMA 1, 3, 4, 6P and IEC IP 67 when connected and secured.

Options: Grey connector body available (special order), change part number VAS .. or VAY .. to VAG ..
For other combinations or options, consult factory.

Dimensions

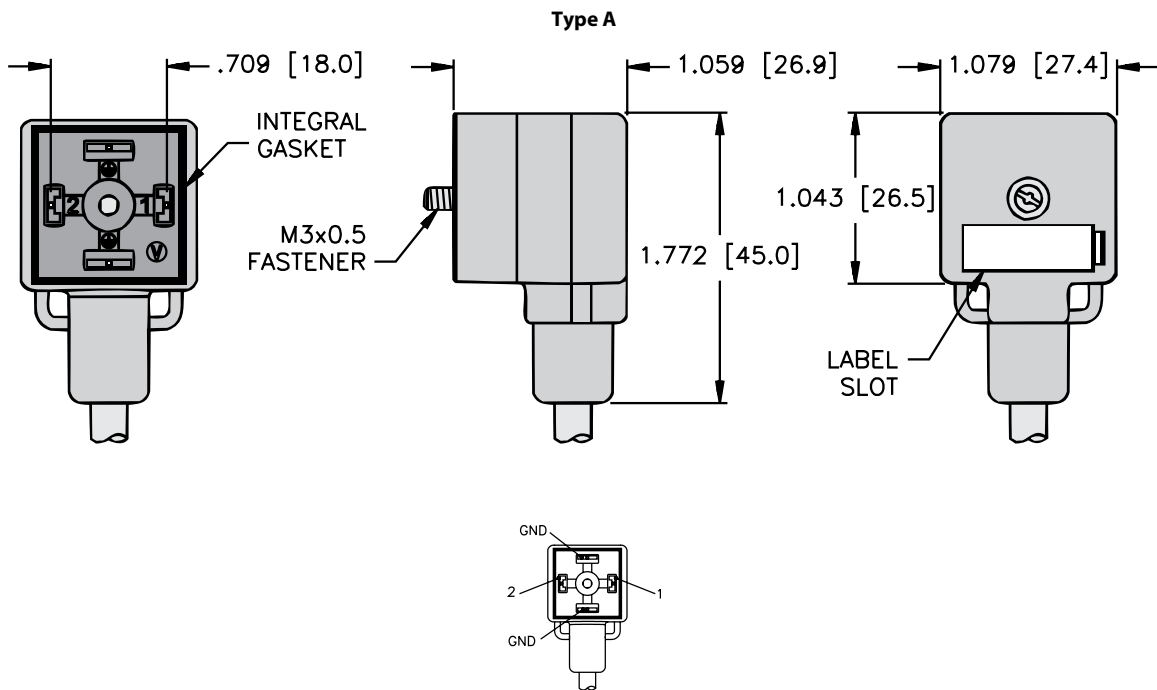

We reserve the right to make technical alterations without prior notice.

Wiring Diagrams

Straight Wired (A)	Indicator LED (B,C)	Indicator LED and MOV (D,E)	Indicator LED and Diode - DC (F)

Valve Plug Connectivity

Valve Connectors, Type "A" (18 mm) Extensions

- Eurofast® and Picofast® Connectors
- Wired for Use with Junction Box
- 2 Conductors + Ground, (Eurofast), Ground Contacts Parallel Wired

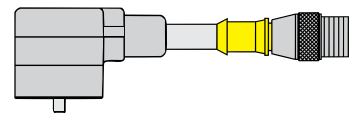

"A" Style Valve Connectors, Eurofast Extension

Eurofast Extension

Application	Cable Specs	Voltage VAC/DC	Straight Wired	Indicator LED	Indicator LED and MOV	Indicator LED and Diode - DC only
Standard duty PVC	3/18 AWG Grey PVC 105 °C 6.2 mm OD	0-220	VAS 22-A653-*M-RS 5.3T	----	----	----
		24-48	----	VAS 22-B653-*M-RS 5.3T	VAS 22-D653-*M-RS 5.3T	VAS 22-F653-*M-RS 5.3T
		110-220	----	VAS 22-C653-*M-RS 5.3T	VAS 22-E653-*M-RS 5.3T	----
Standard duty TPU	3/18 AWG Grey TPU 90 °C 6.0 mm OD	0-220	VAS 22-A669-*M-RS 5.3T	----	----	----
		24-48	----	VAS 22-B669-*M-RS 5.3T	VAS 22-D669-*M-RS 5.3T	VAS 22-F669-*M-RS 5.3T
		110-220	----	VAS 22-C669-*M-RS 5.3T	VAS 22-E669-*M-RS 5.3T	----

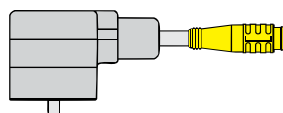

Picofast Snap Extension

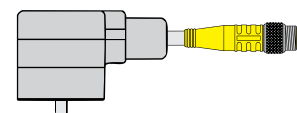

Picofast Threaded Extension

"A" Style Valve Connectors, Picofast Extension

Application	Cable Specs	Voltage VAC/DC	Straight Wired	Indicator LED	Indicator LED and MOV	Indicator LED and Diode - DC only
Small diameter, PVC Snap lock	3/24 AWG Yellow PVC 105 °C 4.4 mm OD	0-125	VAS 22-A642-*M-PSG 3	----	----	----
		24-48	----	VAS 22-B642-*M-PSG 3	VAS 22-D642-*M-PSG 3	VAS 22-F642-*M-PSG 3
		110-220	----	----	----	----
Small diameter, TPU Snap lock	3/24 AWG Black TPU 90 °C 4.2 mm OD	0-125	VAS 22-A587-*M-PSG 3	----	----	----
		24-48	----	VAS 22-B587-*M-PSG 3	VAS 22-D587-*M-PSG 3	VAS 22-F587-*M-PSG 3
		110-220	----	----	----	----
Small diameter, PVC Threaded	3/24 AWG Yellow PVC 105 °C 4.4 mm OD	0-125	VAS 22-A642-*M-PSG 3M	----	----	----
		24-48	----	VAS 22-B642-*M-PSG 3M	VAS 22-D642-*M-PSG 3M	VAS 22-F642-*M-PSG 3M
		110-220	----	----	----	----
Small diameter, TPU Threaded	3/24 AWG Black TPU 90 °C 4.2 mm OD	0-125	VAS 22-A587-*M-PSG 3M	----	----	----
		24-48	----	VAS 22-B587-*M-PSG 3M	VAS 22-D587-*M-PSG 3M	VAS 22-F587-*M-PSG 3M
		110-220	----	----	----	----

* Length in meters.

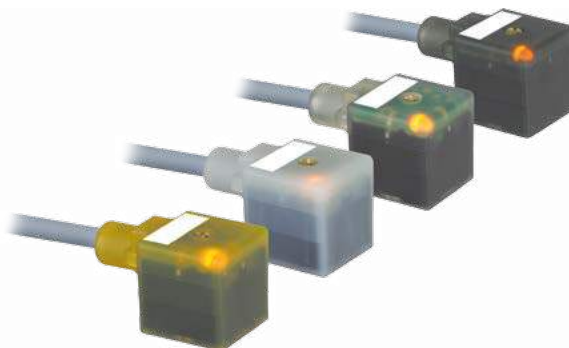

We reserve the right to make technical alterations without prior notice.

Type "A" (18 mm) Valve Connector to Eurofast® Extension

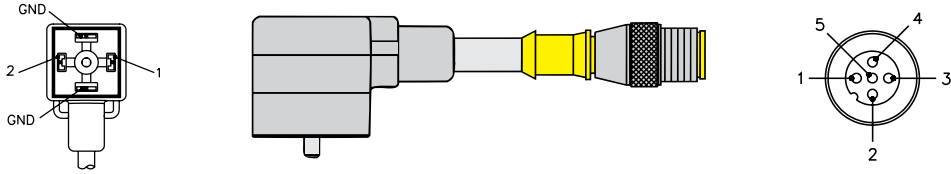

Wiring Diagrams

Straight Wired (A)	Indicator LED (B, C)	Indicator LED and MOV (D, E)	Indicator LED and Diode - DC (F)

We reserve the right to make technical alterations without prior notice.

Type "A" (18 mm) Valve Connector to Eurofast Extension

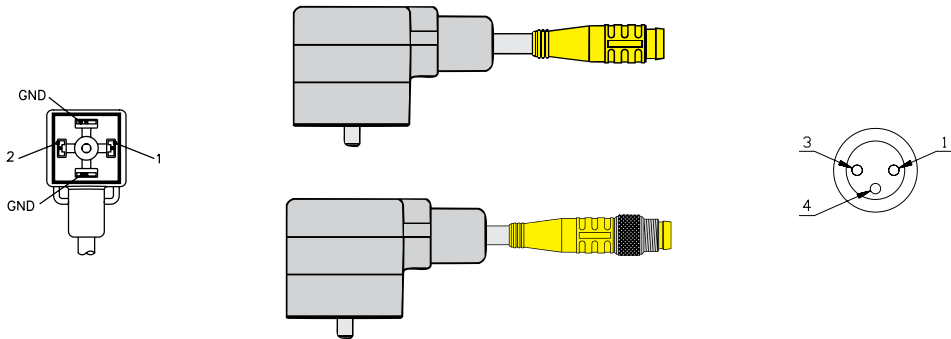

Wiring Diagrams

Straight Wired (A)	Indicator LED (B, C)	Indicator LED and MOV (D, E)	Indicator LED and Diode - DC (F)

Valve Plug

Valve Plug Connectivity

Valve Connectors, Type "A" (18 mm) Extensions

- Minifast® and Microfast® Connectors
- Available with PVC and TPU Jackets
- 18 AWG
- 2 Conductors + Ground, Ground Contacts Parallel Wired

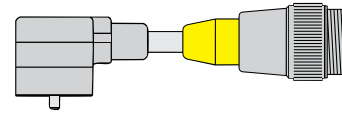

"A" Style Valve Connectors, Minifast Extension

Minifast Extension

Application	Cable Specs	Voltage VAC/DC	Straight Wired	Indicator LED	Indicator LED and MOV**
Standard duty PVC	3/18 AWG, Grey PVC 105 °C 6.2 mm OD Black Body	0-220	VAS 22-A653-*M-RSM 30	----	----
		24-48	----	VAS 22-B653-*M-RSM 30	VAS 22-D653-*M-RSM 30
		110-220	----	VAS 22-C653-*M-RSM 30	VAS 22-E653-*M-RSM 30
Standard duty TPU	3/18 AWG, Grey TPU 90 °C 6.2 mm OD Black Body	0-220	VAS 22-A669-*M-RSM 30	----	----
		24-48	----	VAS 22-B669-*M-RSM 30	VAS 22-D669-*M-RSM 30
		110-220	----	VAS 22-C669-*M-RSM 30	VAS 22-E669-*M-RSM 30

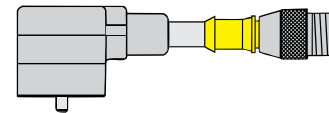

"A" Style Valve Connectors, Microfast Extension

Microfast Extension

Application	Cable Specs	Voltage VAC/DC	Straight Wired	Indicator LED	Indicator LED and MOV**
Standard duty PVC	3/18 AWG, Grey PVC 105 °C 6.2 mm OD Black Body	0-220	VAS 22-A653-*M-SB 3T	----	----
		24-48	----	VAS 22-B653-*M-SB 3T	VAS 22-D653-*M-SB 3T
		110-220	----	VAS 22-C653-*M-SB 3T	VAS 22-E653-*M-SB 3T
Standard duty TPU	3/18 AWG, Grey TPU 90 °C 6.0 mm OD Black Body	0-220	VAS 22-A669-*M-SB 3T	----	----
		24-48	----	VAS 22-B669-*M-SB 3T	VAS 22-D669-*M-SB 3T
		110-220	----	VAS 22-C669-*M-SB 3T	VAS 22-E669-*M-SB 3T

* Length in meters.

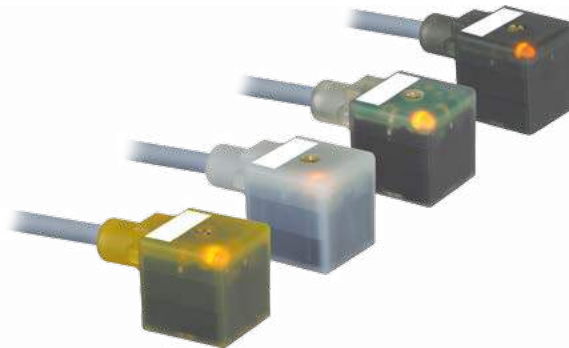

We reserve the right to make technical alterations without prior notice.

Type "A" (18 mm) Valve Connector to Minifast® Extension

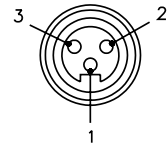
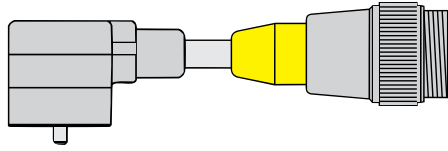
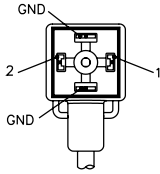

Wiring Diagrams

Straight Wired (A)	Indicator LED (B, C)	Indicator LED and MOV (D, E)

We reserve the right to make technical alterations without prior notice.

Type "A" (18 mm) Valve Connector to Microfast® Extension

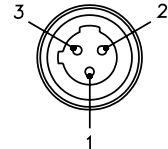
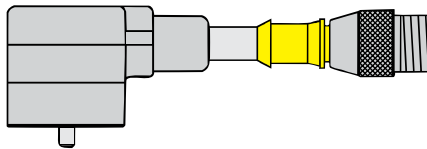
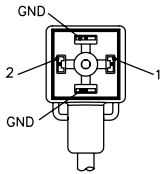

Wiring Diagrams

Straight Wired (A)	Indicator LED (B, C)	Indicator LED and MOV (D, E)

Valve Plug

Valve Plug Connectivity

Valve Connectors Type "A" (18 mm), 3 Conductors + Ground

- Available with PVC and TPU Jackets
- 18 and 24 AWG
- 3 Conductors + Ground

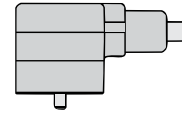

"A" Style Valve Connectors, IEC Color Code

Type A

Application	Cable Specs	Pinout	Voltage VAC/DC	Straight Wired	Indicator LED	Indicator LED and MOV**
Standard duty PVC	4/18 AWG, Grey PVC 105 °C 6.7 mm OD	1. BN 2. BU 3. WH Gnd - BK	0-220 24-48 110-220	VAS 3-A580-*M ---- ----	---- VAS 3-B580-*M VAS 3-C580-*M	---- VAS 3-D580-*M VAS 3-E580-*M
Standard duty TPU	4/18 AWG, Yellow TPU 90 °C 7.2 mm OD	1. BN 2. BU 3. WH Gnd - BK	0-220 24-48 110-220	VAS 3-A544-*M ---- ----	---- VAS 3-B544-*M VAS 3-C544-*M	---- VAS 3-D544-*M VAS 3-E544-*M

* Length in meters.

We reserve the right to make technical alterations without prior notice.

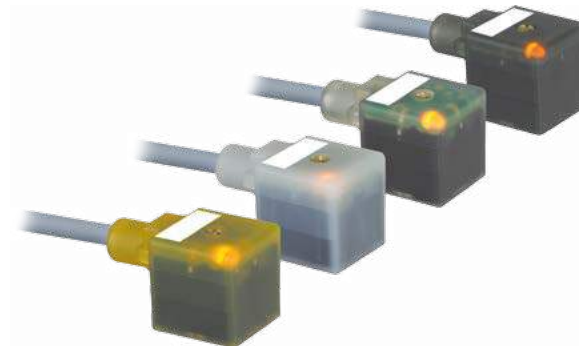

Valve Connectors Type "A" (18 mm), 3 Conductors + Ground

Specifications

- Connectors:** Oil resistant polyurethane body material, Nylon contact carrier.
- Contacts:** Silver plated copper alloy.
- Cable:** See table.
- Cable Length:** Standard cable lengths are nominal 2, 5 and 10 meters. Other lengths available by request - consult factory.
- Protection Class:** NEMA 1, 3, 4, 6P and IEC IP 67 when connected and secured.

Options: Grey connector body available (special order), change part number VAS .. or VAY .. to VAG ..
For other combinations or options, consult factory.

Dimensions

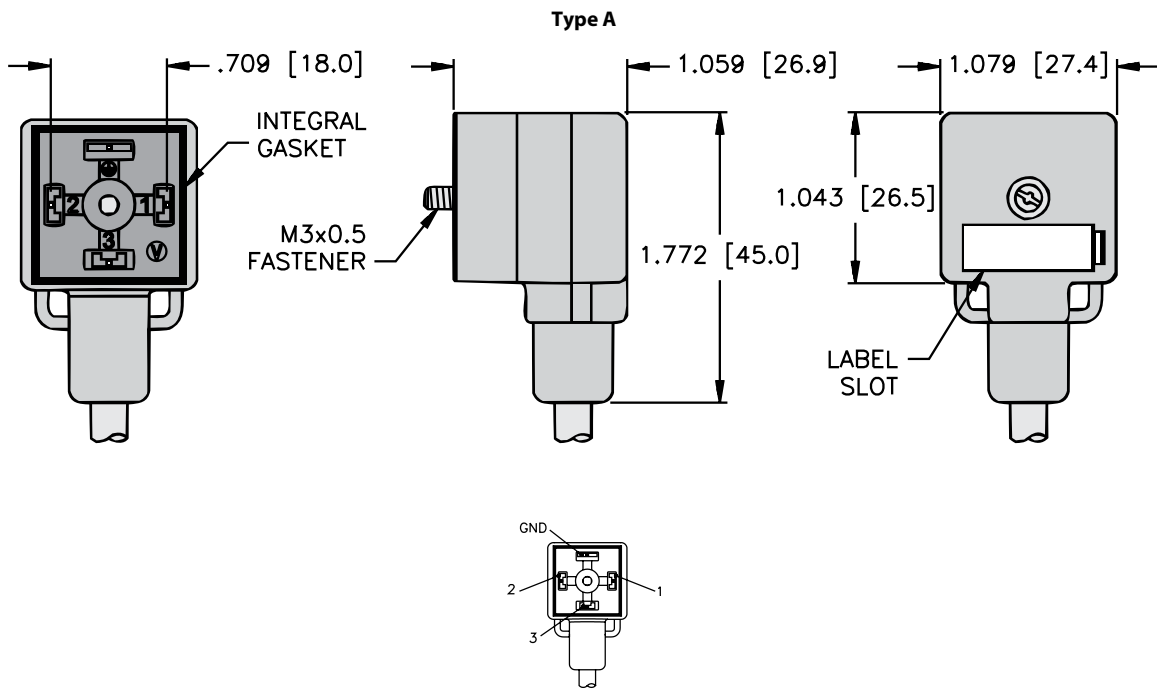

We reserve the right to make technical alterations without prior notice.

Wiring Diagrams

Straight Wired (A)	Indicator LED (B, C)	Indicator LED and MOV (D, E)

Valve Plug

Valve Plug Connectivity

Valve Connectors, Type "A" (18 mm) Extensions

- Eurofast® Connectors
- Available with PVC and TPU Jackets
- 18 AWG
- 3 Conductors + Ground

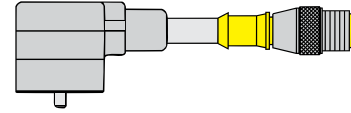

"A" Style Valve Connectors, Eurofast Extension

Eurofast Extension

Application	Cable Specs	Voltage VAC/DC	Straight Wired	Indicator LED	Indicator LED and MOV**
Standard duty PVC	4/18 AWG, Grey PVC	0-220	VAS 3-A580-*M-RSC 5.42T	----	----
	105 °C	24-48	----	VAS 3-B580-*M-RSC 5.42T	VAS 3-D580-*M-RSC 5.42T
	6.7 mm OD Black Body	110-220	----	VAS 3-C580-*M-RSC 5.42T	VAS 3-E580-*M-RSC 5.42T
Standard duty TPU	4/18 AWG, Yellow TPU	0-220	VAS 3-A544-*M-RSC 5.42T	----	----
	90 °C	24-48	----	VAS 3-B544-*M-RSC 5.42T	VAS 3-D544-*M-RSC 5.42T
	7.2 mm OD Black Body	110-220	----	VAS 3-C544-*M-RSC 5.42T	VAS 3-E544-*M-RSC 5.42T

* Length in meters.

We reserve the right to make technical alterations without prior notice.

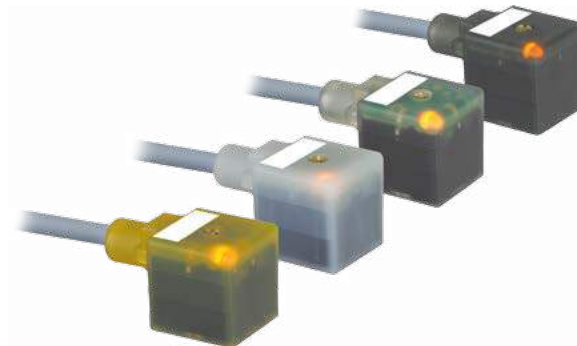

Type "A" (18 mm) Valve Connector to Eurofast® Extension

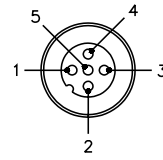
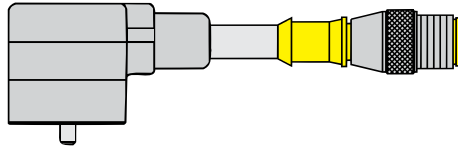
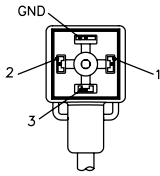

Wiring Diagrams

Straight Wired (A)	Indicator LED (B, C)	Indicator LED and MOV (D, E)
<p>1 ————— 2</p> <p>2 ————— 3</p> <p>3 ————— 4</p> <p>GND ————— 5</p>	<p>Diagram showing the wiring for the Indicator LED (B, C) configuration. The circuit includes a bridge with a yellow LED (YE) and a resistor.</p>	<p>Diagram showing the wiring for the Indicator LED and MOV (D, E) configuration. The circuit includes a bridge with a yellow LED (YE), a MOV, and a resistor.</p>

We reserve the right to make technical alterations without prior notice.

Valve Plug Connectivity

Valve Connectors, Type "B" (10 mm)

- Available with PVC and TPU Jackets
- 18 and 24 AWG
- 2 Conductors + Ground

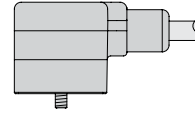

"B" Style Valve Connectors, Standard Color Code

Type B

Application	Cable Specs	Pinout	Voltage VAC/DC	Straight Wired	Indicator LED	Indicator LED and MOV**	Indicator LED and Diode - DC only
Standard duty PVC	3/18 AWG, Grey PVC 105 °C 6.2 mm OD Black Body	1. BK 1 2. BK 2 Gnd - GN/YE	0-220	VBS 2-A653-*M	----	----	----
			24-48	----	VBS 2-B653-*M	VBS 2-D653-*M	VBS 2-F653-*M
			110-220	----	VBS 2-C653-*M	VBS 2-E653-*M	----
Standard duty TPU	3/18 AWG, Grey TPU 90 °C 6.0 mm OD Black Body	1. BK 1 2. BK 2 Gnd - GN/YE	0-220	VBS 2-A669-*M	----	----	----
			24-48	----	VBS 2-B669-*M	VBS 2-D669-*M	VBS 2-F669-*M
			110-220	----	VBS 2-C669-*M	VBS 2-E669-*M	----

"B" Style Valve Connectors, IEC Color Code

Application	Cable Specs	Pinout	Voltage VAC/DC	Straight Wired	Indicator LED	Indicator LED and MOV**	Indicator LED and Diode - DC only
Small diameter PVC	3/24 AWG, Yellow PVC 105 °C 4.4 mm OD Black Body	1. BN 2. BU Gnd - BK	0-220	VBS 2-A642-*M	----	----	----
			24-48	----	VBS 2-B642-*M	VBS 2-D642-*M	VBS 2-F642-*M
			110-220	----	VBS 2-C642-*M	VBS 2-E642-*M	----
Small diameter TPU	3/24 AWG, Black TPU 90 °C 4.2 mm OD Black Body	1. BN 2. BU Gnd - BK	0-220	VBS 2-A587-*M	----	----	----
			24-48	----	VBS 2-B587-*M	VBS 2-D587-*M	VBS 2-F587-*M
			110-220	----	VBS 2-C587-*M	VBS 2-E587-*M	----

* Length in meters.

We reserve the right to make technical alterations without prior notice.

Specifications

- Connectors:** Oil resistant polyurethane body material, Nylon contact carrier.
- Contacts:** Silver plated copper alloy.
- Cable:** See table.
- Cable Length:** Standard cable lengths are nominal 2, 5 and 10 meters. Other lengths available by request - consult factory.
- Protection Class:** NEMA 1, 3, 4, 6P and IEC IP 67 when connected and secured.

Options: Grey connector body available (special order), change part number VBS .. or VBY .. to VBG ..
 To have cable exit on the same side as the ground pin, change part number from VBS .. to TBS ..
 For other combinations or options, consult factory.

Dimensions

Type B

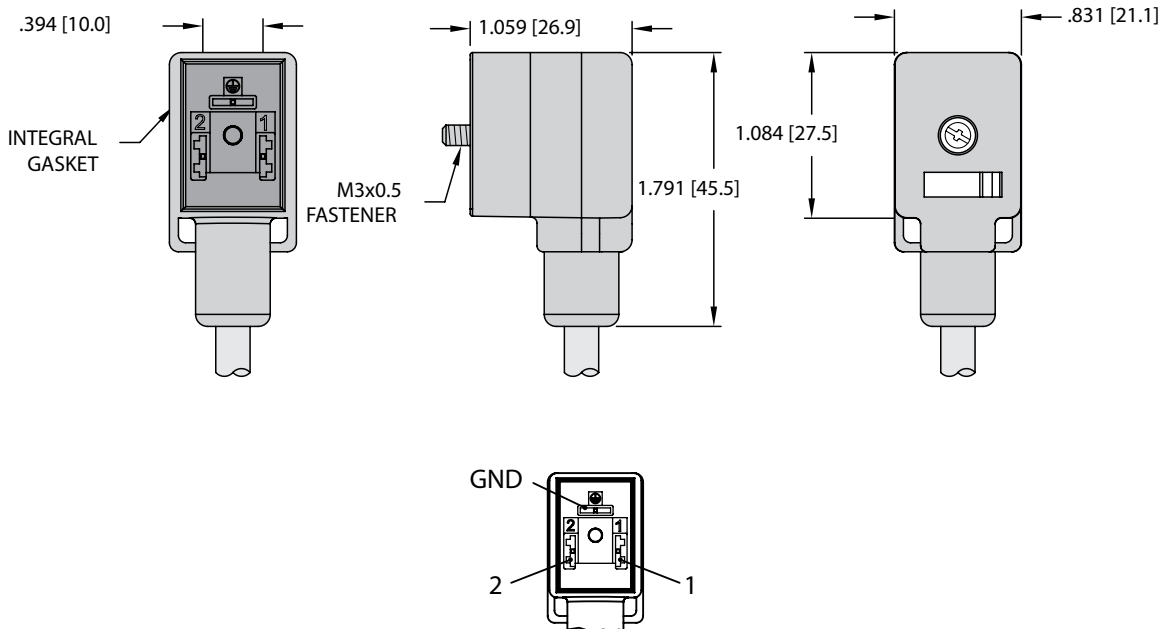

We reserve the right to make technical alterations without prior notice.

Valve Plug

Wiring Diagrams

Straight Wired (A)	Indicator LED (B, C)	Indicator LED and MOV (D, E)	Indicator LED and Diode - DC (F)

Valve Plug Connectivity

Valve Connectors, Type "B" (10 mm) Extensions

- Available with PVC, TPU and Jackets
- 18 and 24 AWG
- 2 Conductors + Ground, Ground Contacts Parallel Wired

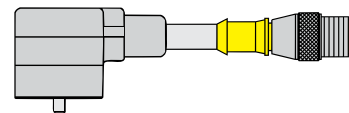

"B" Style Valve Connectors, Eurofast® Extension

Eurofast Extension

Application	Cable Specs	Voltage VAC/DC	Straight Wired	Indicator LED	Indicator LED and MOV	Indicator LED and Diode - DC only
Standard duty PVC	3/18 AWG Grey PVC 105 °C 6.2 mm OD	0-220	VBS 2-A653-*M-RS 5.3T	----	----	----
		24-48	----	VBS 2-B653-*M-RS 5.3T	VBS 2-D653-*M-RS 5.3T	VBS 2-F653-*M-RS 5.3T
		110-220	----	VBS 2-C653-*M-RS 5.3T	VBS 2-E653-*M-RS 5.3T	----
Standard duty TPU	3/18 AWG Grey TPU 90 °C 6.0 mm OD	0-220	VBS 2-A669-*M-RS 5.3T	----	----	----
		24-48	----	VBS 2-B669-*M-RS 5.3T	VBS 2-D669-*M-RS 5.3T	VBS 2-F669-*M-RS 5.3T
		110-220	----	VBS 2-C669-*M-RS 5.3T	VBS 2-E669-*M-RS 5.3T	----

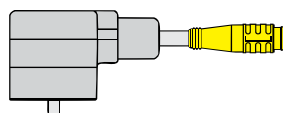

Picofast Snap Extension

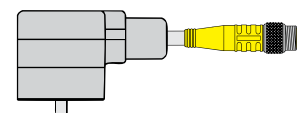

Picofast Threaded Extension

"B" Style Valve Connectors, Picofast® Extension

Application	Cable Specs	Voltage VAC/DC	Straight Wired	Indicator LED	Indicator LED and MOV	Indicator LED and Diode - DC only
Small diameter, PVC Snap lock	3/24 AWG Yellow PVC 105 °C 4.4 mm OD	0-125	VBS 2-A642-*M-PSG 3	----	----	----
		24-48	----	VBS 2-B642-*M-PSG 3	VBS 2-D642-*M-PSG 3	VBS 2-F642-*M-PSG 3
		110-220	----	----	----	----
Small diameter, TPU Snap lock	3/24 AWG Black TPU 90 °C 4.2 mm OD	0-125	VBS 2-A587-*M-PSG 3	----	----	----
		24-48	----	VBS 2-B587-*M-PSG 3	VBS 2-D587-*M-PSG 3	VBS 2-F587-*M-PSG 3
		110-220	----	----	----	----
Small diameter, PVC Threaded	3/24 AWG Yellow PVC 105 °C 4.4 mm OD	0-125	VBS 2-A642-*M-PSG 3M	----	----	----
		24-48	----	VBS 2-B642-*M-PSG 3M	VBS 2-D642-*M-PSG 3M	VBS 2-F642-*M-PSG 3M
		110-220	----	----	----	----
Small diameter, TPU Threaded	3/24 AWG Black TPU 90 °C 4.2 mm OD	0-125	VBS 2-A587-*M-PSG 3M	----	----	----
		24-48	----	VBS 2-B587-*M-PSG 3M	VBS 2-D587-*M-PSG 3M	VBS 2-F587-*M-PSG 3M
		110-220	----	----	----	----

* Length in meters.

We reserve the right to make technical alterations without prior notice.

Type "B" (10 mm) Valve Connector to Eurofast® Extension

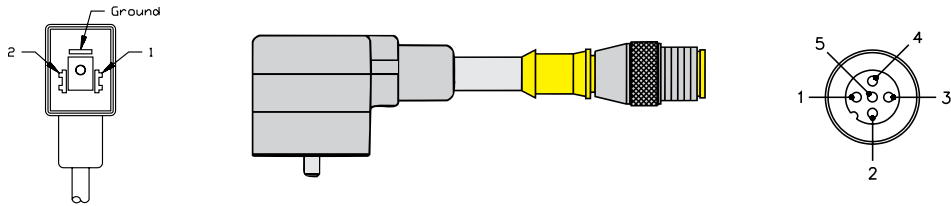

Wiring Diagrams

Straight Wired (A)	Indicator LED (B, C)	Indicator LED and MOV (D, E)	Indicator LED and Diode - DC (F)
<p>1 → 4</p> <p>2 → 3</p> <p>GND → 5</p>			<p>DC ONLY</p>

Type "B" (10 mm) Valve Connector to Picofast® Extension

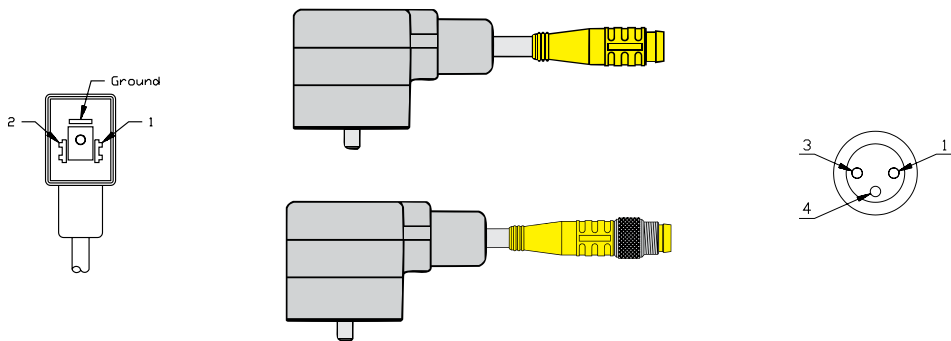

Wiring Diagrams

Straight Wired (A)	Indicator LED (B, C)	Indicator LED and MOV (D, E)	Indicator LED and Diode - DC (F)
<p>1 → 4</p> <p>2 → 3</p> <p>GND → NC</p>			<p>DC ONLY</p>

Valve Plug Connectivity

Valve Connectors, Type "B" (10 mm) Extensions

- Minifast® and Microfast® Connectors
- 18 AWG
- 2 Conductors + Ground

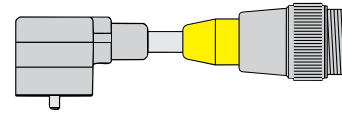

"B" Style Valve Connectors, Minifast Extension

Minifast Extension

Application	Cable Specs	Voltage VAC/DC	Straight Wired	Indicator LED	Indicator LED and MOV**
Standard duty PVC	3/18 AWG, Grey PVC 105 °C 6.2 mm OD Black Body	0-220	VBS 2-A653-*M-RSM 30	----	----
		24-48	----	VBS 2-B653-*M-RSM 30	VBS 2-D653-*M-RSM 30
		110-220	----	VBS 2-C653-*M-RSM 30	VBS 2-E653-*M-RSM 30
Standard duty TPU	3/18 AWG, Grey TPU 90 °C 6.0 mm OD Black Body	0-220	VBS 2-A669-*M-RSM 30	----	----
		24-48	----	VBS 2-B669-*M-RSM 30	VBS 2-D669-*M-RSM 30
		110-220	----	VBS 2-C669-*M-RSM 30	VBS 2-E669-*M-RSM 30

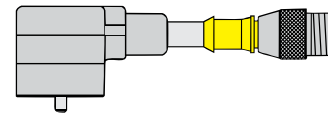

"B" Style Valve Connectors, Microfast Extension

Microfast Extension

Application	Cable Specs	Voltage VAC/DC	Straight Wired	Indicator LED	Indicator LED and MOV**
Standard duty PVC	3/18 AWG, Grey PVC 105 °C 6.2 mm OD Black Body	0-220	VBS 2-A653-*M-SB 3T	----	----
		24-48	----	VBS 2-B653-*M-SB 3T	VBS 2-D653-*M-SB 3T
		110-220	----	VBS 2-C653-*M-SB 3T	VBS 2-E653-*M-SB 3T
Standard duty TPU	3/18 AWG, Grey TPU 90 °C 6.0 mm OD Black Body	0-220	VBS 2-A669-*M-SB 3T	----	----
		24-48	----	VBS 2-B669-*M-SB 3T	VBS 2-D669-*M-SB 3T
		110-220	----	VBS 2-C669-*M-SB 3T	VBS 2-E669-*M-SB 3T

* Length in meters.

We reserve the right to make technical alterations without prior notice.

Type "B" (10 mm) Valve Connector to Minifast® Extension

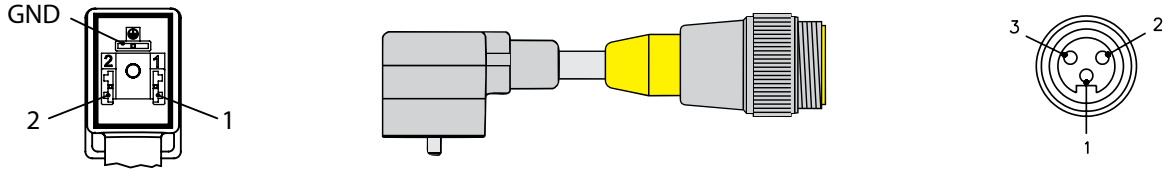

Wiring Diagrams

Straight Wired (A)	Indicator LED (B, C)	Indicator LED and MOV (D, E)
<p>1) —————> 2</p> <p>2) —————> 3</p> <p>GND) —————> 1</p>		

Type "B" (10 mm) Valve Connector to Microfast® Extension

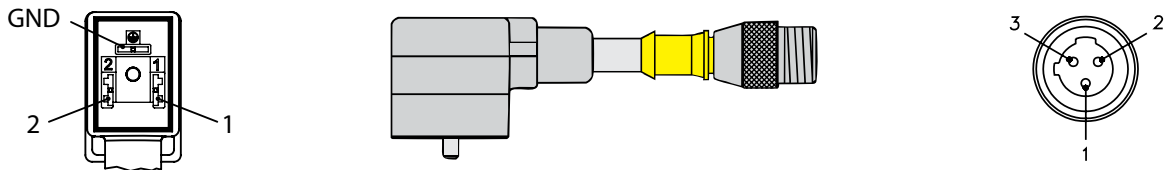

Wiring Diagrams

Straight Wired (A)	Indicator LED (B, C)	Indicator LED and MOV (D, E)
<p>1) —————> 2</p> <p>2) —————> 3</p> <p>GND) —————> 1</p>		

Valve Plug Connectivity

Valve Connectors, Type "I" (11 mm)

- Available with PVC and TPU Jackets
- 18 and 24 AWG
- 2 Conductors + Ground

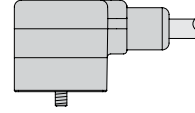

"I" Style Valve Connectors, Standard Color Code

Type I

Application	Cable Specs	Pinout	Voltage VAC/DC	Straight Wired	Indicator LED	Indicator LED and MOV**	Indicator LED and Diode - DC only
Standard duty PVC	3/18 AWG, Grey PVC 105 °C 6.2 mm OD Black Body	1. BK 1 2. BK 2 Gnd - GN/YE	0-220	VIS 2-A653-*M	----	----	----
			24-48	----	VIS 2-B653-*M	VIS 2-D653-*M	VIS 2-F653-*M
			110-220	----	VIS 2-C653-*M	VIS 2-E653-*M	----
Standard duty TPU	3/18 AWG, Grey TPU 90 °C 6.0 mm OD Black Body	1. BK 1 2. BK 2 Gnd - GN/YE	0-220	VIS 2-A669-*M	----	----	----
			24-48	----	VIS 2-B669-*M	VIS 2-D669-*M	VIS 2-F669-*M
			110-220	----	VIS 2-C669-*M	VIS 2-E669-*M	----

"I" Style Valve Connectors, IEC Color Code

Application	Cable Specs	Pinout	Voltage VAC/DC	Straight Wired	Indicator LED	Indicator LED and MOV**	Indicator LED and Diode - DC only
Small diameter PVC	3/24 AWG, Yellow PVC 105 °C 4.4 mm OD Black Body	1. BN 2. BU Gnd - BK	0-220	VIS 2-A642-*M	----	----	----
			24-48	----	VIS 2-B642-*M	VIS 2-D642-*M	VIS 2-F642-*M
			110-220	----	VIS 2-C642-*M	VIS 2-E642-*M	----
Small diameter TPU	3/24 AWG, Black TPU 90 °C 4.2 mm OD Black Body	1. BN 2. BU Gnd - BK	0-220	VIS 2-A587-*M	----	----	----
			24-48	----	VIS 2-B587-*M	VIS 2-D587-*M	VIS 2-F587-*M
			110-220	----	VIS 2-C587-*M	VIS 2-E587-*M	----

* Length in meters.

We reserve the right to make technical alterations without prior notice.

Specifications

- Connectors:** Oil resistant polyurethane body material, Nylon contact carrier.
- Contacts:** Silver plated copper alloy.
- Cable:** See table.
- Cable Length:** Standard cable lengths are nominal 2, 5 and 10 meters. Other lengths available by request - consult factory.
- Protection Class:** NEMA 1, 3, 4, 6P and IEC IP 67 when connected and secured.

Options: Grey connector body available (special order), change part number VIS .. or VIY .. to VIG ..
 To have cable exit on the same side as the ground pin, change part number from VIS .. to TIS ..
 For other combinations or options, consult factory.

Dimensions

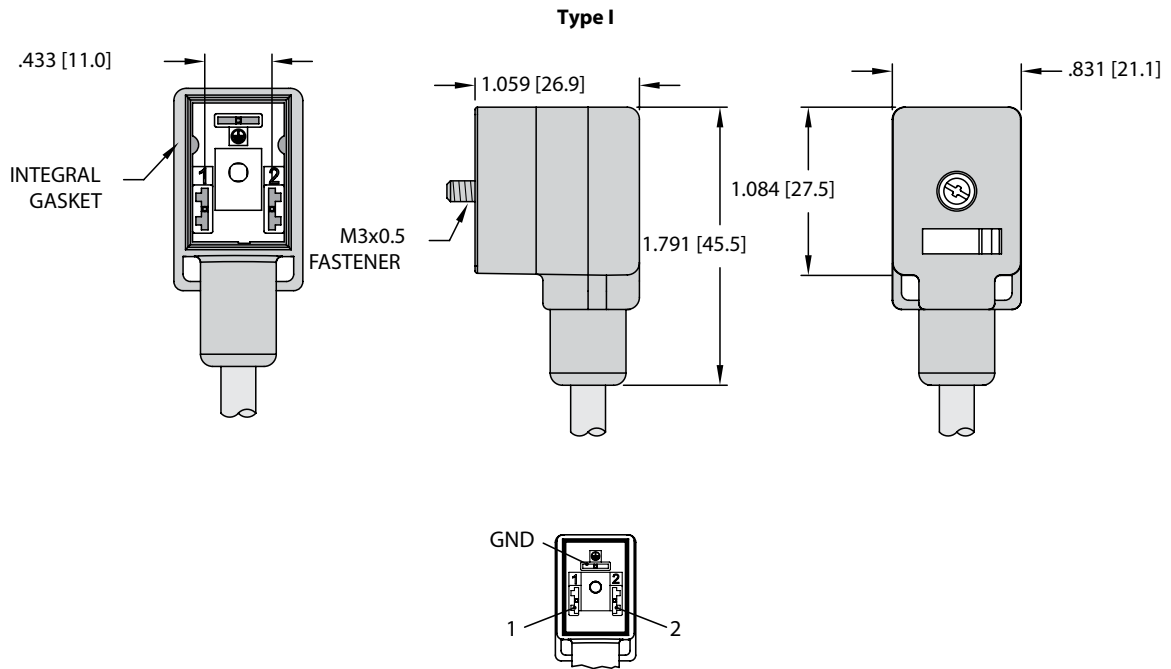

We reserve the right to make technical alterations without prior notice.

Valve Plug

Wiring Diagrams

Straight Wired (A)	Indicator LED (B, C)	Indicator LED and MOV (D, E)	Indicator LED and Diode - DC (F)
<p>1) ———— 2) ———— GND) ————</p>	<p>1) ———— 2) ———— GND) ————</p>	<p>1) ———— 2) ———— GND) ————</p>	<p>DC ONLY 1) ———— 2) ———— GND) ————</p>

Valve Plug Connectivity

Valve Connectors, Type "I" (11 mm) Extensions

- Eurofast® and Picofast® Connectors
- Wired for use with Junction Box
- 2 Conductors + Ground

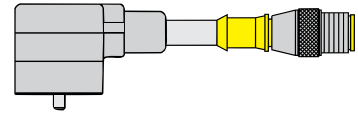

"I" Style Valve Connectors, Eurofast Extension

Eurofast Extension

Application	Cable Specs	Voltage VAC/DC	Straight Wired	Indicator LED	Indicator LED and MOV	Indicator LED and Diode - DC only
Standard duty PVC	3/18 AWG Grey PVC 105 °C 6.2 mm OD	0-220	VIS 2-A653-*M-RS 5.3T	----	----	----
		24-48	----	VIS 2-B653-*M-RS 5.3T	VIS 2-D653-*M-RS 5.3T	VIS 2-F653-*M-RS 5.3T
		110-220	----	VIS 2-C653-*M-RS 5.3T	VIS 2-E653-*M-RS 5.3T	----
Standard duty TPU	3/18 AWG Grey TPU 90 °C 6.0 mm OD	0-220	VIS 2-A669-*M-RS 5.3T	----	----	----
		24-48	----	VIS 2-B669-*M-RS 5.3T	VIS 2-D669-*M-RS 5.3T	VIS 2-F669-*M-RS 5.3T
		110-220	----	VIS 2-C669-*M-RS 5.3T	VIS 2-E669-*M-RS 5.3T	----

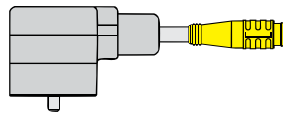

Picofast Snap Extension

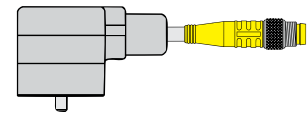

Picofast Threaded Extension

"I" Style Valve Connectors, Picofast Extension

Application	Cable Specs	Voltage VAC/DC	Straight Wired	Indicator LED	Indicator LED and MOV	Indicator LED and Diode - DC only
Small diameter, PVC Snap lock	3/24 AWG Yellow PVC 105 °C 4.4 mm OD	0-125	VIS 2-A642-*M-PSG 3	----	----	----
		24-48	----	VIS 2-B642-*M-PSG 3	VIS 2-D642-*M-PSG 3	VIS 2-F642-*M-PSG 3
		110-220	----	----	----	----
Small diameter, TPU Snap lock	3/24 AWG Black TPU 90 °C 4.2 mm OD	0-125	VIS 2-A587-*M-PSG 3	----	----	----
		24-48	----	VIS 2-B587-*M-PSG 3	VIS 2-D587-*M-PSG 3	VIS 2-F587-*M-PSG 3
		110-220	----	----	----	----
Small diameter, PVC Threaded	3/24 AWG Yellow PVC 105 °C 4.4 mm OD	0-125	VIS 2-A642-*M-PSG 3M	----	----	----
		24-48	----	VIS 2-B642-*M-PSG 3M	VIS 2-D642-*M-PSG 3M	VIS 2-F642-*M-PSG 3M
		110-220	----	----	----	----
Small diameter, TPU Threaded	3/24 AWG Black TPU 90 °C 4.2 mm OD	0-125	VIS 2-A587-*M-PSG 3M	----	----	----
		24-48	----	VIS 2-B587-*M-PSG 3M	VIS 2-D587-*M-PSG 3M	VIS 2-F587-*M-PSG 3M
		110-220	----	----	----	----

* Length in meters.

We reserve the right to make technical alterations without prior notice.

Type "I" (11 mm) Valve Connector to Eurofast® Extension

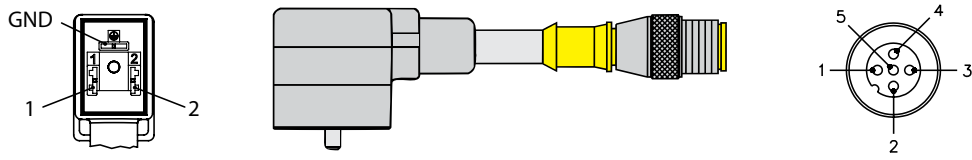

Wiring Diagrams

Straight Wired (A)	Indicator LED (B, C)	Indicator LED and MOV (D, E)	Indicator LED and Diode - DC (F)
<p>1 → 4</p> <p>2 → 3</p> <p>GND → 5</p>			<p>DC ONLY</p>

Type "I" (11 mm) Valve Connector to Picofast® Extension

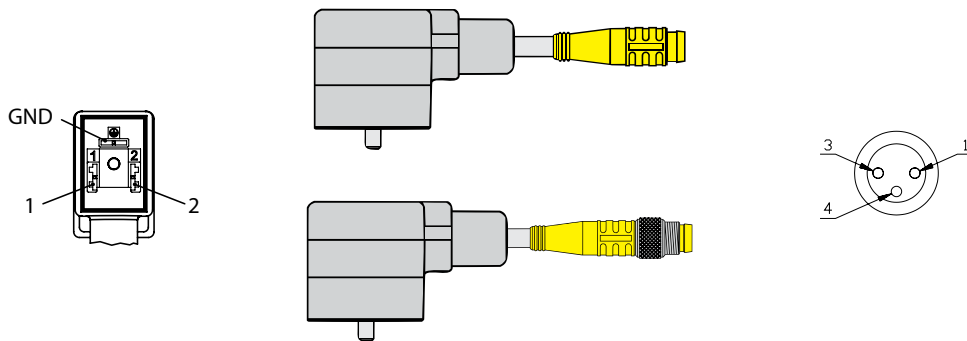

Wiring Diagrams

Straight Wired (A)	Indicator LED (B, C)	Indicator LED and MOV (D, E)	Indicator LED and Diode - DC (F)
<p>1 → 4</p> <p>2 → 3</p> <p>GND → NC</p>			<p>DC ONLY</p>

Valve Plug Connectivity

Valve Connectors, Type "I" (11 mm) Extensions

- Minifast® and Microfast® Connectors
- Available with PVC and TPU
- 18 AWG
- 2 Conductors + Ground (Eurofast)

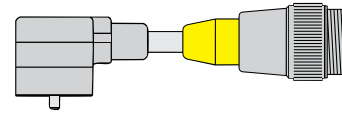

"I" Style Valve Connectors, Minifast Extension

Minifast Extension

Application	Cable Specs	Voltage VAC/DC	Straight Wired	Indicator LED	Indicator LED and MOV**
Standard duty PVC	3/18 AWG, Grey PVC 105 °C 6.2 mm OD Black Body	0-220	VIS 2-A653-*M-RSM 30	----	----
		24-48	----	VIS 2-B653-*M-RSM 30	VIS 2-D653-*M-RSM 30
		110-220	----	VIS 2-C653-*M-RSM 30	VIS 2-E653-*M-RSM 30
Standard duty TPU	3/18 AWG, Grey TPU 90 °C 6.0 mm OD Black Body	0-220	VIS 2-A669-*M-RSM 30	----	----
		24-48	----	VIS 2-B669-*M-RSM 30	VIS 2-D669-*M-RSM 30
		110-220	----	VIS 2-C669-*M-RSM 30	VIS 2-E669-*M-RSM 30

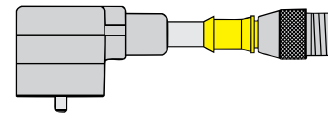

"I" Style Valve Connectors, Microfast Extension

Microfast Extension

Application	Cable Specs	Voltage VAC/DC	Straight Wired	Indicator LED	Indicator LED and MOV**
Standard duty PVC	3/18 AWG, Grey PVC 105 °C 6.2 mm OD Black Body	0-220	VIS 2-A653-*M-SB 3T	----	----
		24-48	----	VIS 2-B653-*M-SB 3T	VIS 2-D653-*M-SB 3T
		110-220	----	VIS 2-C653-*M-SB 3T	VIS 2-E653-*M-SB 3T
Standard duty TPU	3/18 AWG, Grey TPU 90 °C 6.0 mm OD Black Body	0-220	VIS 2-A669-*M-SB 3T	----	----
		24-48	----	VIS 2-B669-*M-SB 3T	VIS 2-D669-*M-SB 3T
		110-220	----	VIS 2-C669-*M-SB 3T	VIS 2-E669-*M-SB 3T

* Length in meters.

We reserve the right to make technical alterations without prior notice.

Type "I" (11 mm) Valve Connector to Minifast® Extension

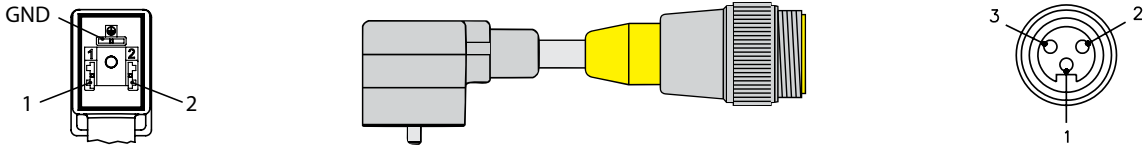

Wiring Diagrams

Straight Wired (A)	Indicator LED (B, C)	Indicator LED and MOV (D, E)
<p>1) → 2</p> <p>2) → 3</p> <p>GND) → 1</p>		

Type "I" (11 mm) Valve Connector to Microfast® Extension

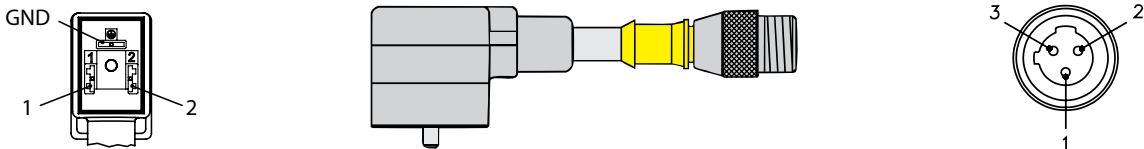

Wiring Diagrams

Straight Wired (A)	Indicator LED (B, C)	Indicator LED and MOV (D, E)
<p>1) → 2</p> <p>2) → 3</p> <p>GND) → 1</p>		

Valve Plug Connectivity

Valve Connectors, Type "C" (8 mm)

- Available with PVC and TPU Jackets
- 18 and 24 AWG
- 2 Conductor + Ground

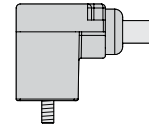

"C" (8.0 mm) Style Valve Connectors, Standard Color Code

Type C

Application	Cable Specs	Pinout	Voltage VAC/DC	Straight Wired	Indicator LED	Indicator LED and Suppressor Diodes
Standard duty PVC	3/18 AWG, Grey PVC 105 °C 6.2 mm OD Black Body	1. BK 1 2. BK 2 Gnd - GN/YE	0-220	TC8S 2-A653-*M	----	----
			24	----	TC8S 2-L653-*M	TC8S 2-P653-*
			48	----	TC8S 2-M653-*M	----
			110	----	TC8S 2-N653-*M	----
Standard duty TPU	3/18 AWG, Grey TPU 90 °C 6.0 mm OD Black Body	1. BK 1 2. BK 2 Gnd - GN/YE	0-220	TC8S 2-A669-*M	----	----
			24	----	TC8S 2-L669-*M	TC8S 2-P669-*
			48	----	TC8S 2-M669-*M	----
			110	----	TC8S 2-N669-*M	----

"C" (8.0 mm) Style Valve Connectors, IEC Color Code

Application	Cable Specs	Pinout	Voltage VAC/DC	Straight Wired	Indicator LED	Indicator LED and Suppressor Diodes
Small diameter PVC	3/24 AWG, Yellow PVC 105 °C 4.4 mm OD Black Body	1. BN 2. BU Gnd - BK	0-220	TC8S 2-A642-*M	----	----
			24	----	TC8S 2-L642-*M	TC8S 2-P642-*
			48	----	TC8S 2-M642-*M	----
			110	----	TC8S 2-N642-*M	----
Small diameter TPU	3/24 AWG, Black TPU 90 °C 4.2 mm OD Black Body	1. BN 2. BU Gnd - BK	0-220	TC8S 2-A587-*M	----	----
			24	----	TC8S 2-L587-*M	TC8S 2-P587-*
			48	----	TC8S 2-M587-*M	----
			110	----	TC8S 2-N587-*M	----

* Length in meters.

We reserve the right to make technical alterations without prior notice.

Specifications

- Connectors:** Oil resistant polyurethane body material, Nylon contact carrier.
- Contacts:** Silver plated copper alloy.
- Cable:** See table.
- Cable Length:** Standard cable lengths are nominal 5 meters. Other lengths available by request - consult factory.
- Protection Class:** NEMA 1, 3, 4, 6P and IEC IP 67 when connected and secured.

Options: Grey connector body available (special order), change part number TC8S... To TC8G...
For other combinations or options, consult factory.

Dimensions

Type C (8 mm)

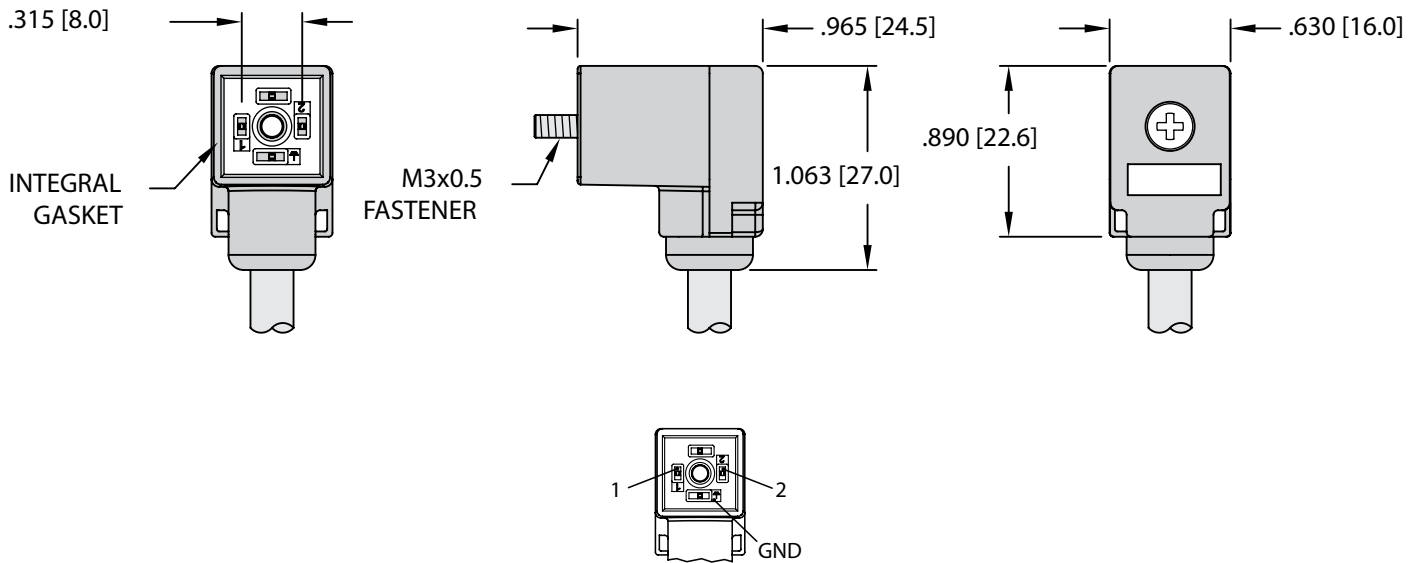

We reserve the right to make technical alterations without prior notice.

Wiring Diagrams

Straight Wired (A)	Indicator LED (L, M, N)	Indicator LED and Suppressor Diodes (P)

Valve Plug Connectivity

Valve Connectors, Type "C" (8 mm) Extensions

- Available with PVC and TPU Jackets
- 18 and 24 AWG
- 2 Conductor + Ground (Eurofast®)

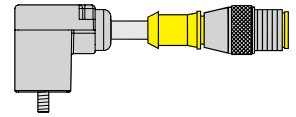

"C" (8.0 mm) Style Valve Connectors, Eurofast Extension

Eurofast Extension

Application	Cable Specs	Voltage VAC/DC	Straight Wired	Indicator LED	Indicator LED and Suppressor Diodes
Standard duty PVC	3/18 AWG, Grey PVC	0-220	TC8S 2-A653-*M-RS 5.3T	----	----
	105 °C	24	----	TC8S 2-L653-*M-RS 5.3T	TC8S 2-P653-*M-RS 5.3T
	6.2 mm OD	48	----	TC8S 2-M653-*M-RS 5.3T	----
	Black Body	110	----	TC8S 2-N653-*M-RS 5.3T	----
Standard duty TPU	3/18 AWG, Grey TPU	0-220	TC8S 2-A669-*M-RS 5.3T	----	----
	90 °C	24	----	TC8S 2-L669-*M-RS 5.3T	TC8S 2-P669-*M-RS 5.3T
	6.0 mm OD	48	----	TC8S 2-M669-*M-RS 5.3T	----
	Black Body	110	----	TC8S 2-N669-*M-RS 5.3T	----

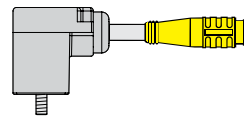

Picofast Snap Extension

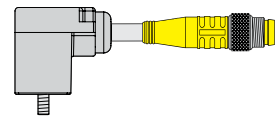

Picofast Threaded Extension

"C" (8.0 mm) Style Valve Connectors, Picofast® Extension

Application	Cable Specs	Voltage VAC/DC	Straight Wired	Indicator LED	Indicator LED and Suppressor Diodes
Small diameter, PVC Snap Lock	3/24 AWG	0-125	TC8S 2-A642-*M-PSG 3	----	----
	Yellow PVC	24	----	TC8S 2-L642-*M-PSG 3	TC8S 2-P642-*M-PSG 3
	105 °C	48	----	TC8S 2-M642-*M-PSG 3	----
Small diameter, TPU Snap Lock	3/24 AWG	0-125	TC8S 2-A587-*M-PSG 3	----	----
	Black TPU	24	----	TC8S 2-L587-*M-PSG 3	TC8S 2-P587-*M-PSG 3
	90 °C	48	----	TC8S 2-M587-*M-PSG 3	----
Small diameter, PVC Threaded	3/24 AWG	0-125	TC8S 2-A642-*M-PSG 3M	----	----
	Yellow PVC	24	----	TC8S 2-L642-*M-PSG 3M	TC8S 2-P642-*M-PSG 3M
	105 °C	48	----	TC8S 2-M642-*M-PSG 3M	----
Small diameter, TPU Threaded	3/24 AWG	0-125	TC8S 2-A587-*M-PSG 3M	----	----
	Black TPU	24	----	TC8S 2-L587-*M-PSG 3M	TC8S 2-P587-*M-PSG 3M
	90 °C	48	----	TC8S 2-M587-*M-PSG 3M	----

* Length in meters.

We reserve the right to make technical alterations without prior notice.

Type "C" (8 mm) Valve Connector to Eurofast® Extension

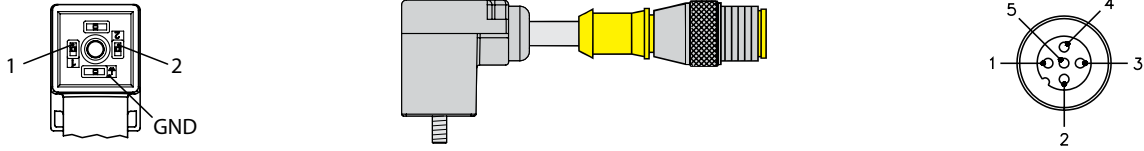

Wiring Diagrams

Straight Wired (A)	Indicator LED (L, M, N)	Indicator LED and Suppressor Diodes (P)
<p>1 → 4</p> <p>2 → 3</p> <p>GND → 5</p>		

Type "C" (8 mm) Valve Connector to Picofast® Extension

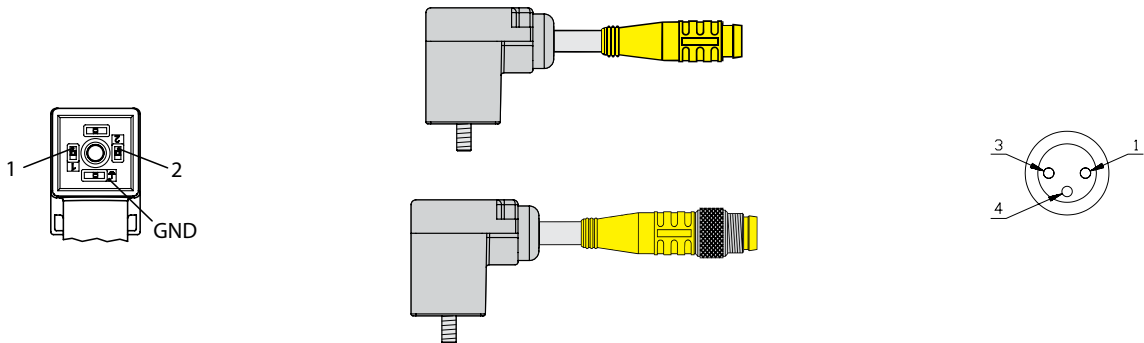

Wiring Diagrams

Straight Wired (A)	Indicator LED (L, M)	Indicator LED and Suppressor Diodes (P)
<p>1 → 4</p> <p>2 → 3</p> <p>GND → NC</p>		

Valve Plug Connectivity

Valve Connectors, Type "C" (8 mm) Extensions

- Available with PVC and TPU Jackets
- 18 AWG
- 2 Conductor + Ground

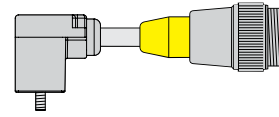

"C" (8.0 mm) Style Valve Connectors, Minifast® Extension

Minifast Extension

Application	Cable Specs	Voltage VAC/DC	Straight Wired	Indicator LED	Indicator LED and Suppressor Diodes
Standard duty PVC	3/18 AWG, Grey PVC	0-220	TC8S 2-A653-*M-RSM 30	----	----
	105 °C	24	----	TC8S 2-L653-*M-RSM 30	TC8S 2-P653-*M-RSM 30
	6.2 mm OD	48	----	TC8S 2-M653-*M-RSM 30	----
	Black Body	110	----	TC8S 2-N653-*M-RSM 30	----
Standard duty TPU	3/18 AWG, Grey TPU	0-220	TC8S 2-A669-*M-RSM 30	----	----
	90 °C	24	----	TC8S 2-L669-*M-RSM 30	TC8S 2-P669-*M-RSM 30
	6.0 mm OD	48	----	TC8S 2-M669-*M-RSM 30	----
	Black Body	110	----	TC8S 2-N669-*M-RSM 30	----

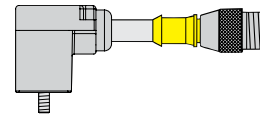

"C" (8.0 mm) Style Valve Connectors, Microfast® Extension

Microfast Extension

Application	Cable Specs	Voltage VAC/DC	Straight Wired	Indicator LED	Indicator LED and Suppressor Diodes
Standard duty PVC	3/18 AWG, Grey PVC	0-220	TC8S 2-A653-*M-SB 3T	----	----
	105 °C	24	----	TC8S 2-L653-*M-SB 3T	TC8S 2-P653-*M-SB 3T
	6.2 mm OD	48	----	TC8S 2-M653-*M-SB 3T	----
	Black Body	110	----	TC8S 2-N653-*M-SB 3T	----
Standard duty TPU	3/18 AWG, Grey TPU	0-220	TC8S 2-A669-*M-SB 3T	----	----
	90 °C	24	----	TC8S 2-L669-*M-SB 3T	TC8S 2-P669-*M-SB 3T
	6.0 mm OD	48	----	TC8S 2-M669-*M-SB 3T	----
	Black Body	110	----	TC8S 2-N669-*M-SB 3T	----

* Length in meters.

We reserve the right to make technical alterations without prior notice.

Type "C" (8 mm) Valve Connector to Minifast® Extension

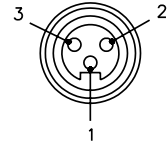
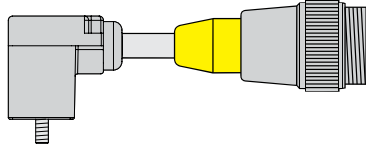
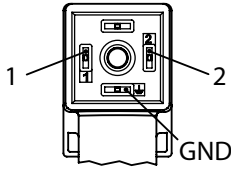

Wiring Diagrams

Straight Wired (A)	Indicator LED (L, M)	Indicator LED and Suppressor Diodes (P)
<p>1) —————> 2</p> <p>2) —————> 3</p> <p>GND) —————> 1</p>		

Type "C" (8 mm) Valve Connector Microfast® Extension

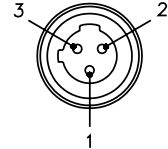
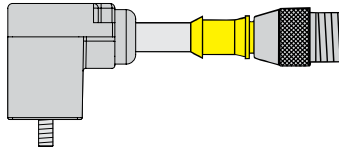
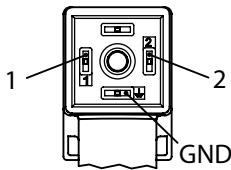

Wiring Diagrams

Straight Wired (A)	Indicator LED (L, M)	Indicator LED and Suppressor Diodes (P)
<p>1) —————> 2</p> <p>2) —————> 3</p> <p>GND) —————> 1</p>		

Valve Plug Connectivity

Valve Connectors, Type "C" (9.4 mm)

- Available with PVC and TPU Jackets
- 18 and 24 AWG
- 2 Conductor + Ground

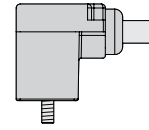

"C" (9.4 mm) Style Valve Connectors, Standard Color Code

Type C

Application	Cable Specs	Pinout	Voltage VAC/DC	Straight Wired	Indicator LED	Indicator LED and Suppressor Diodes
Standard duty PVC	3/18 AWG, Grey PVC	1. BK 1 2. BK 2 Gnd-GN/YE	0-220	TC9S 2-A653-*M	----	----
	105 °C		24	----	TC9S 2-L653-*M	TC9S 2-P653-*
	6.2 mm OD		48	----	TC9S 2-M653-*M	----
	Black Body		110	----	TC9S 2-N653-*M	----
Standard duty TPU	3/18 AWG, Grey TPU	1. BK 1 2. BK 2 Gnd-GN/YE	0-220	TC9S 2-A669-*M	----	----
	90 °C		24	----	TC9S 2-L669-*M	TC9S 2-P669-*
	6.0 mm OD		48	----	TC9S 2-M669-*M	----
	Black Body		110	----	TC9S 2-N669-*M	----

"C" (9.4 mm) Style Valve Connectors, IEC Color Code

Application	Cable Specs	Pinout	Voltage VAC/DC	Straight Wired	Indicator LED	Indicator LED and Suppressor Diodes
Small diameter PVC	3/24 AWG, Yellow PVC	1. BN 2. BU Gnd - BK	0-220	TC9S 2-A642-*M	----	----
	105 °C		24	----	TC9S 2-L642-*M	TC9S 2-P642-*
	4.4 mm OD		48	----	TC9S 2-M642-*M	----
	Black Body		110	----	TC9S 2-N642-*M	----
Small diameter TPU	3/24 AWG, Black TPU	1. BN 2. BU Gnd - BK	0-220	TC9S 2-A587-*M	----	----
	90 °C		24	----	TC9S 2-L587-*M	TC9S 2-P587-*
	4.2 mm OD		48	----	TC9S 2-M587-*M	----
	Black Body		110	----	TC9S 2-N587-*M	----

* Length in meters.

We reserve the right to make technical alterations without prior notice.

Valve Connectors, Type "C" (9.4 mm)

Specifications

- Connectors:** Oil resistant polyurethane body material, Nylon contact carrier.
- Contacts:** Silver plated copper alloy.
- Cable:** See table.
- Cable Length:** Standard cable lengths are nominal 5 meters. Other lengths available by request - consult factory.
- Protection Class:** NEMA 1, 3, 4, 6P and IEC IP 67 when connected and secured.

Options: Grey connector body available (special order), change part number TC9S...to TC9G...
For other combinations or options, consult factory.

Dimensions

Type C (9.4 mm)

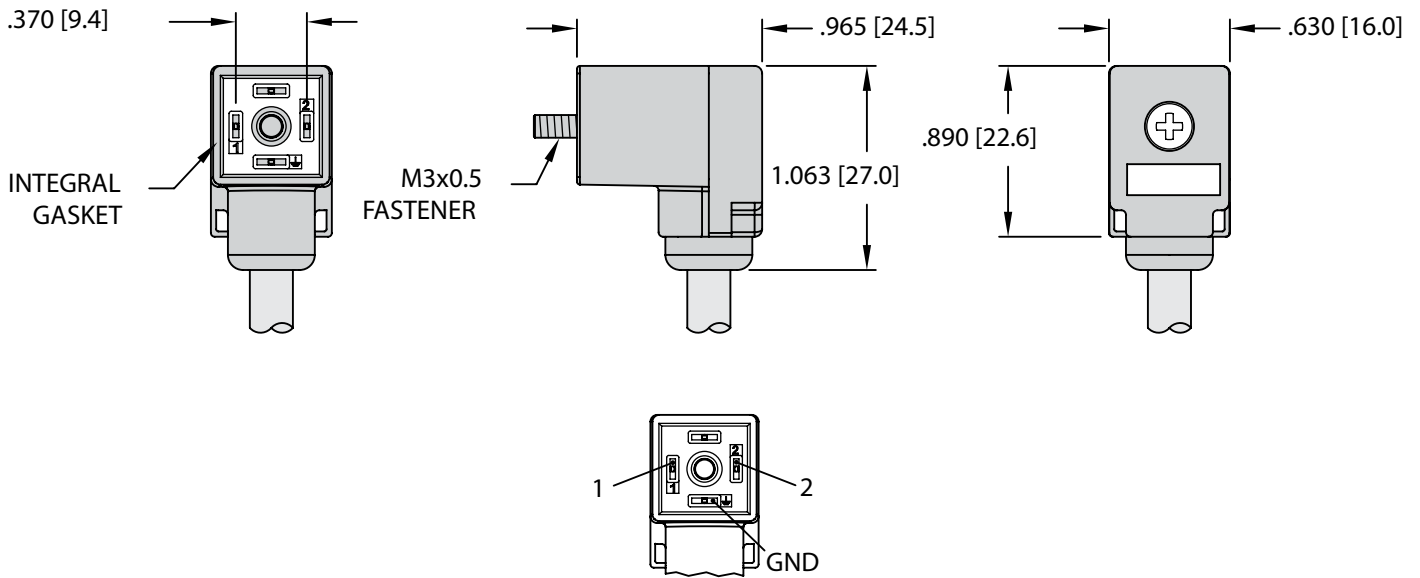

We reserve the right to make technical alterations without prior notice.

Wiring Diagrams

Straight Wired (A)	Indicator LED (L, M, N)	Indicator LED and Suppressor Diodes (P)

Valve Plug Connectivity

Valve Connectors, Type "C" (9.4 mm) Extensions

- Available with PVC and TPU Jackets
- 2 Conductor + Ground (Eurofast®)

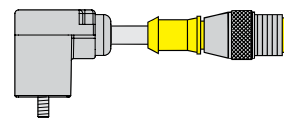

"C" (9.4 mm) Style Valve Connectors, Eurofast Extension

Eurofast Extension

Application	Cable Specs	Voltage VAC/DC	Straight Wired	Indicator LED	Indicator LED and Suppressor Diodes
Standard duty PVC	3/18 AWG, Grey PVC	0-220	TC9S 2-A653-*M-RS 5.3T	----	----
	105 °C	24	----	TC9S 2-L653-*M-RS 5.3T	TC9S 2-P653-*M-RS 5.3T
	6.2 mm OD	48	----	TC9S 2-M653-*M-RS 5.3T	----
	Black Body	110	----	TC9S 2-N653-*M-RS 5.3T	----
Standard duty TPU	3/18 AWG, Grey TPU	0-220	TC9S 2-A669-*M-RS 5.3T	----	----
	90 °C	24	----	TC9S 2-L669-*M-RS 5.3T	TC9S 2-P669-*M-RS 5.3T
	6.0 mm OD	48	----	TC9S 2-M669-*M-RS 5.3T	----
	Black Body	110	----	TC9S 2-N669-*M-RS 5.3T	----

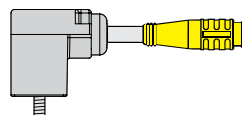

Picofast Snap Extension

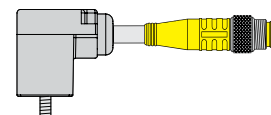

Picofast Threaded Extension

"C" Style Valve Connectors, Picofast® Extension

Application	Cable Specs	Voltage VAC/DC	Straight Wired	Indicator LED	Indicator LED and Suppressor Diodes
Small diameter, PVC Snap lock	3/24 AWG	0-125	TC9S 2-A642-*M-PSG 3	----	----
	Yellow PVC	24	----	TC9S 2-L642-*M-PSG 3	TC9S 2-P642-*M-PSG 3
	105 °C	48	----	TC9S 2-M642-*M-PSG 3	----
Small diameter, TPU Snap lock	3/24 AWG	0-125	TC9S 2-A587-*M-PSG 3	----	----
	Black TPU	24	----	TC9S 2-L587-*M-PSG 3	TC9S 2-P587-*M-PSG 3
	90 °C	48	----	TC9S 2-M587-*M-PSG 3	----
Small diameter, PVC Threaded	3/24 AWG	0-125	TC9S 2-A642-*M-PSG 3M	----	----
	Yellow PVC	24	----	TC9S 2-L642-*M-PSG 3M	TC9S 2-P642-*M-PSG 3M
	105 °C	48	----	TC9S 2-M642-*M-PSG 3M	----
Small diameter, TPU Threaded	3/24 AWG	0-125	TC9S 2-A587-*M-PSG 3M	----	----
	Black TPU	24	----	TC9S 2-L587-*M-PSG 3M	TC9S 2-P587-*M-PSG 3M
	90 °C	48	----	TC9S 2-M587-*M-PSG 3M	----

* Length in meters.

We reserve the right to make technical alterations without prior notice.

Type "C" (9.4 mm) Valve Connector to Eurofast® Extension

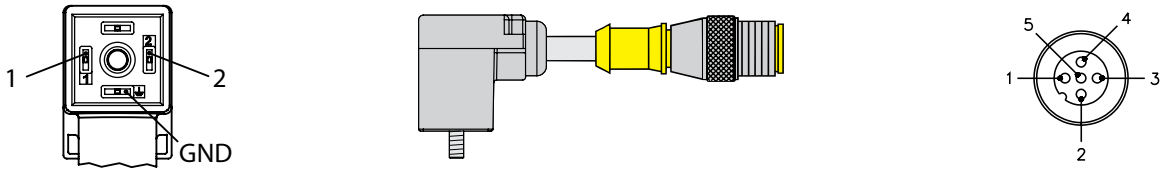

Wiring Diagrams

Straight Wired (A)	Indicator LED (L, M, N)	Indicator LED and Suppressor Diodes (P)
<p>1 → 4</p> <p>2 → 3</p> <p>GND → 5</p>		

Type "C" (9.4 mm) Valve Connector to Picofast® Extension

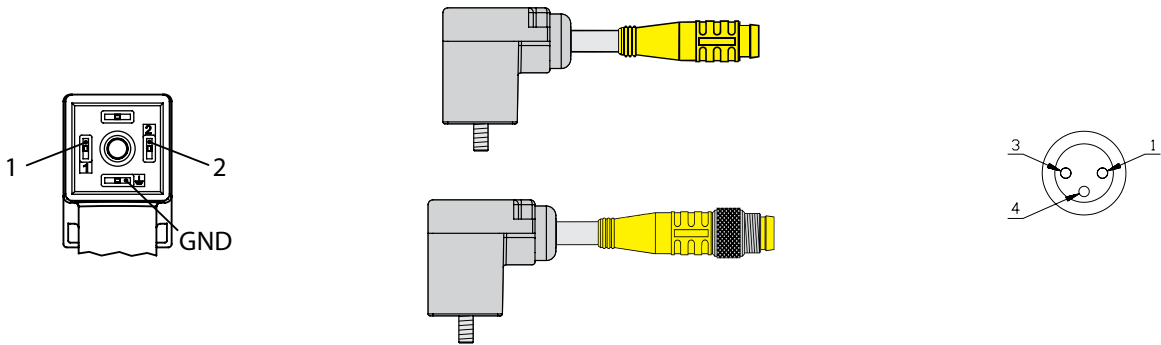

Wiring Diagrams

Straight Wired (A)	Indicator LED (L, M)	Indicator LED and Suppressor Diodes (P)
<p>1 → 4</p> <p>2 → 3</p> <p>GND → NC</p>		

Valve Plug Connectivity

Valve Connectors, Type "C" (9.4 mm) Extensions

- Available with PVC and TPU Jackets
- 18 AWG
- 2 Conductor + Ground

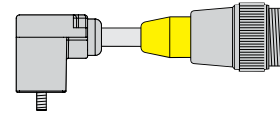

"C" (9.4 mm) Style Valve Connectors, Minifast® Extension

Minifast Extension

Application	Cable Specs	Voltage VAC/DC	Straight Wired	Indicator LED	Indicator LED and Suppressor Diodes
Standard duty PVC	3/18 AWG, Grey PVC	0-220	TC9S 2-A653-*M-RSM 30	----	----
	105 °C	24	----	TC9S 2-L653-*M-RSM 30	TC9S 2-P653-*M-RSM 30
	6.2 mm OD	48	----	TC9S 2-M653-*M-RSM 30	----
	Black Body	110	----	TC9S 2-N653-*M-RSM 30	----
Standard duty TPU	3/18 AWG, Grey TPU	0-220	TC9S 2-A669-*M-RSM 30	----	----
	90 °C	24	----	TC9S 2-L669-*M-RSM 30	TC9S 2-P669-*M-RSM 30
	6.0 mm OD	48	----	TC9S 2-M669-*M-RSM 30	----
	Black Body	110	----	TC9S 2-N669-*M-RSM 30	----

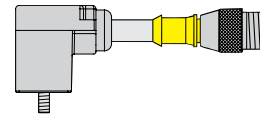

"C" (9.4 mm) Style Valve Connectors, Microfast® Extension

Microfast Extension

Application	Cable Specs	Voltage VAC/DC	Straight Wired	Indicator LED	Indicator LED and Suppressor Diodes
Standard duty PVC	3/18 AWG, Grey PVC	0-220	TC9S 2-A653-*M-SB 3T	----	----
	105 °C	24	----	TC9S 2-L653-*M-SB 3T	TC9S 2-P653-*M-SB 3T
	6.2 mm OD	48	----	TC9S 2-M653-*M-SB 3T	----
	Black Body	110	----	TC9S 2-N653-*M-SB 3T	----
Standard duty TPU	3/18 AWG, Grey TPU	0-220	TC9S 2-A669-*M-SB 3T	----	----
	90 °C	24	----	TC9S 2-L669-*M-SB 3T	TC9S 2-P669-*M-SB 3T
	6.0 mm OD	48	----	TC9S 2-M669-*M-SB 3T	----
	Black Body	110	----	TC9S 2-N669-*M-SB 3T	----

* Length in meters.

We reserve the right to make technical alterations without prior notice.

Type "C" (9.4 mm) Valve Connector to Minifast® Extension

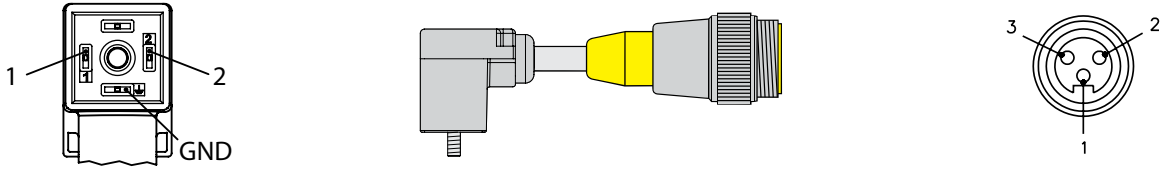

Wiring Diagrams

Straight Wired (A)	Indicator LED (L, M, N)	Indicator LED and Suppressor Diodes (P)
<p>1) —————> 2</p> <p>2) —————> 3</p> <p>GND) —————> 1</p>		

Type "C" (9.4 mm) Valve Connector to Microfast® Extension

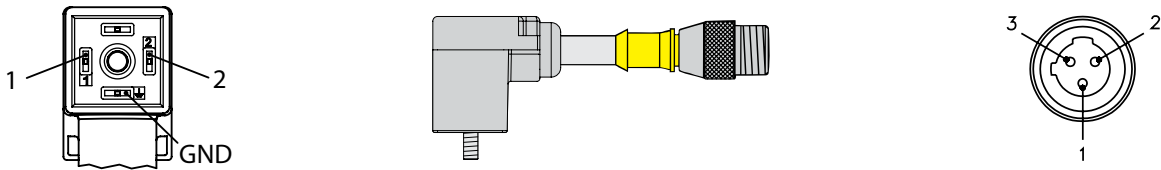

Wiring Diagrams

Straight Wired (A)	Indicator LED (L, M, N)	Indicator LED and Suppressor Diodes (P)
<p>1) —————> 2</p> <p>2) —————> 3</p> <p>GND) —————> 1</p>		

Valve Plug Connectivity

Valve Connectors w/Integral Eurofast® or Picofast® Connector

- Integral Eurofast and Picofast Connectors
- Compact Size
- 2 Conductor + Ground (Eurofast)

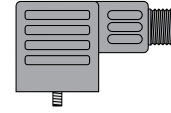

“A” Style Valve Connectors, Integral Eurofast Connector

Eurofast

Application	Pinout	Voltage VAC/DC	Straight Wired	Indicator LED	Indicator LED and MOV
“A” Style Connector with Integral Eurofast connector 2 Conductors, 1 Ground Ground contacts Parallel wired		0-220 24-48	VAS 22-A-FS 5.3 ----	---- ----	---- VAS 22-D-FS 5.3

* Length in meters.



We reserve the right to make technical alterations without prior notice.

Specifications

- Specifications:** Oil resistant polyurethane body material, Nylon valve plug contact carrier, TPU Eurofast contact carrier.
- Contacts:** Valve plug: silver plated copper alloy; Eurofast: gold plated brass.
- Temperature:** -30 °C to +80 °C (-22 °F to +176 °F).
- Protection Class:** NEMA 1, 3, 4, 6P and IEC IP 67 when connected and secured.

Dimensions

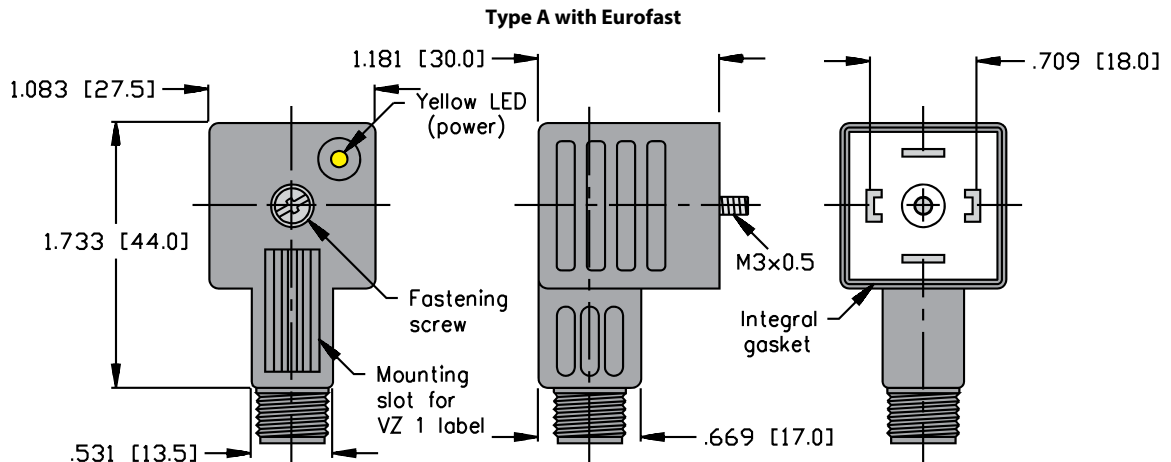

Wiring Diagrams

Straight Wired (A)	Indicator LED (L, M, N)	Indicator LED and Suppressor Diodes (P)

We reserve the right to make technical alterations without prior notice.

Valve Plug

Valve Plug Connectivity

Eurofast® 2 Branch Splitters with Valve Plugs

- Combine 2 Valve Plugs into 1 Eurofast
- For Use w/Eurofast J-boxes w/2 Signals/Port
- Available with All Valve Plug Styles (A, B, I and C)

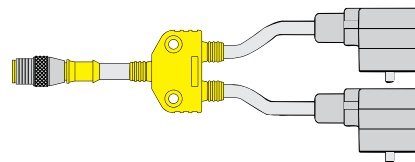

4-wire Series-Wired VB2

Application	Specifications	Wiring Diagram	Part Number
Combine 2 valve plugs into 1 cable. For use with 2 signal / port junction boxes. "A" style (18 mm) valve plugs.	220 VAC/DC 4.0 A RS 4.5T = Grey PVC, 5.3 mm OD, 4/22 AWG Valve plug = Grey PVC, 6.2 mm OD 3/18 AWG	Diagram A	VB2-RS 4.5T-*/2VAS 22-A653-*/*
Combine 2 valve plugs into 1 cable. For use with 2 signal / port junction boxes. "B" style (10 mm) valve plugs.	220 VAC/DC 4.0 A RS 4.5T = Grey PVC 5.3 mm OD, 4/22 AWG Valve plug = Grey PVC, 6.2 mm OD 3/18 AWG	Diagram A	VB2-RS 4.5T-*/2VBS 2-A653-*/*
Combine 2 valve plugs into 1 cable. For use with 2 signal / port junction boxes. "I" style (11 mm) valve plugs.	220 VAC/DC 4.0 A RS 4.5T = Grey PVC, 5.3 mm OD, 4/22 AWG Valve plug = Grey PVC, 6.2 mm OD 3/18 AWG	Diagram A	VB2-RS 4.5T-*/2VIS 2-A653-*/*
Combine 2 valve plugs into 1 cable. For use with 2 signal / port junction boxes. "C" style (8 mm) valve plugs.	220 VAC/DC 4.0 A RS 4.5T = Grey PVC, 5.3 mm OD, 4/22 AWG Valve plug = Grey PVC, 6.2 mm OD 3/18 AWG	Diagram A	VB2-RS 4.5T-*/2TC8S 2-A653-*/*
Combine 2 valve plugs into 1 cable. For use with 2 signal / port junction boxes. "C" style (9.4 mm) valve plugs.	220 VAC/DC 4.0 A RS 4.5T = Grey PVC, 5.3 mm OD, 4/22 AWG Valve plug = Grey PVC, 6.2 mm OD 3/18 AWG	Diagram A	VB2-RS 4.5T-*/2TC9S 2-A653-*/*

We reserve the right to make technical alterations without prior notice.

* Length in meters.

Diagram A

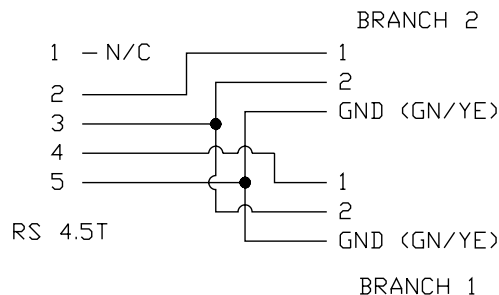

Specifications

Junction Body:	Oil resistant Yellow polyurethane.	Coupling Nuts:	Nickel plated brass.
Connector:	Oil resistant polyurethane body material, Nylon or TPU contact carrier.	Cable:	See table.
Contacts:	Gold plated brass (Eurofast). Silver plated copper alloy (V*fast).	Temperature:	-40 °C to +105 °C (-40 °F to +221 °F) - all PVC cable; -40 °C to +90 °C (-40 °F to +194 °F) - with TPU cable.
		Protection:	NEMA 1, 3, 4, 6P and IEC IP 68.

- Cable Length:** Trunk - nominal 1 meter. Branches - nominal 0.3 meters. Other lengths available by request - consult factory.
- Cable Options:** Other jackets available by request - consult factory.
- Valve Options:** Available w/LED or LED+mov, consult factory.
- Eurofast® Options:** Stainless steel coupling nut add "V" to part number (RS .. to RSV ..). Nylon coupling nut add "K" to part number (RS .. to RSK ..). Right angle connectors, change part number (RS .. to WS..).

Dimensions

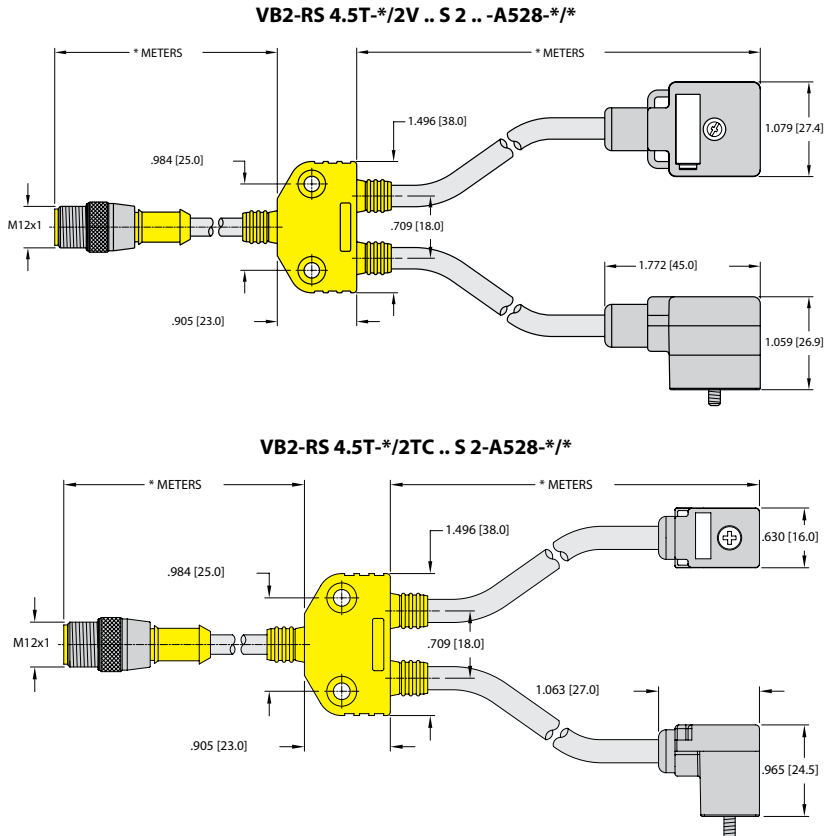

Pinout

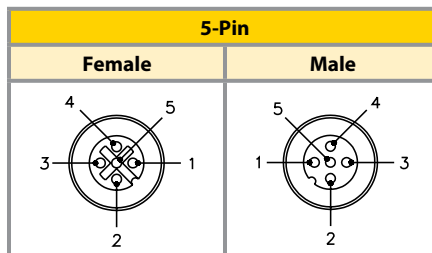

We reserve the right to make technical alterations without prior notice.

Valve Plug

Valve Plug Connectivity

Valve Connectors, Field Wireables

- Convert Hard Wiring Into Quick Disconnect
- Facilitate Field Replacements

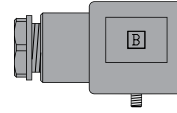

"A" Style Valve Connector

Application	Specifications	Straight Wired
"A" Style Valve Connector	0-220 VAC/DC, 10 A	VAS 3-AW

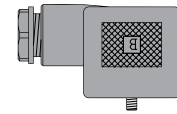

"B" Style Valve Connector

Application	Specifications	Straight Wired
"B" Style Valve Connector	0-220 VAC/DC, 10 A	VBS 2-AW

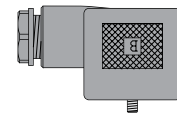

"I" Style Valve Connector

Application	Specifications	Straight Wired
"I" Style Valve Connector	0-220 VAC/DC, 10 A	VIS 2-AW

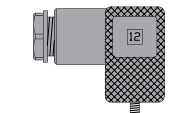

"C" (8 mm) Style Valve Connector

Application	Specifications	Straight Wired
"C" (8 mm) Style Valve Connector	0-220 VAC/DC, 10 A	TC8S 2-AW

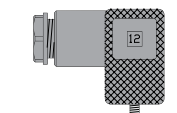

"C" (9.4 mm) Style Valve Connector

Application	Specifications	Straight Wired
"C" (9.4 mm) Style Valve Connector	0-220 VAC/DC, 10 A	TC9S 2-AW

We reserve the right to make technical alterations without prior notice.

Specifications

Housing:	Nylon, black.	Cable Gland:	PG 9 accepts cable diameter 6-8 mm. PG 7 accepts cable diameter 4-6 mm.
Connectors:	Nylon, black.	Temperature:	-25 °C to +90 °C (-13 °F to +194 °F).
Gasket:	Nitrile.	Protection Class:	NEMA 4, 6P and IEC IP 65.
Contacts:	Nickel plated brass		
Terminals:	Screw terminals, conductors to 14 AWG.		

Dimensions

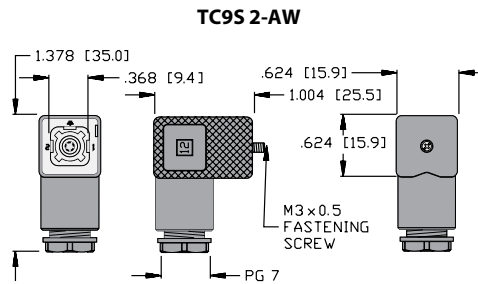
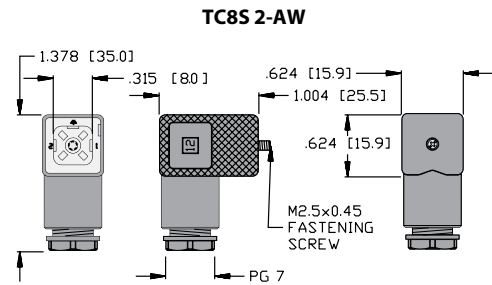
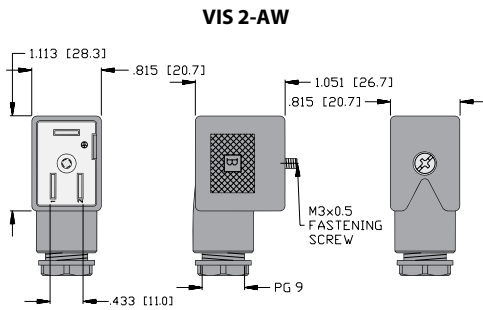
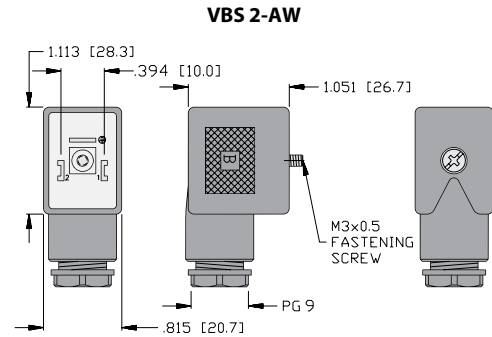
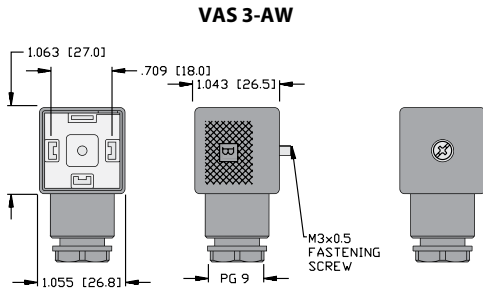

We reserve the right to make technical alterations without prior notice.

Cable Glands	U2
Strain Relief	U5
Snap-In Labels	U5
Lock Nuts	U6
Torque Wrench	U7
Protective Sleeves	U8

Features

- NPT and PG thread cable glands in nylon or metal materials
- Locknuts in multiple thread sizes for receptacle mounting
- M12/M8 torque tool
- Fiberglass and silicone sleeving
- Customizable labels



Liquid Tight Nylon Strain Relief Cable Glands

Communication Rate/Cycle Time

Whenever a metal strain relief cable gland is used, this Nylon Strain Relief Cable Gland can be substituted to save you money without sacrificing performance. Typical applications are: Control cabinets, car washes, hot tubs, instrumentation, carpet cleaning machines, food processing equipment, underground for direct burial, and underwater to 300 ft. (150 PSIG).



Pull-out Resistance - Protection

Flexible, overlapping clamping splines prevent the form seal from being pulled out of the fitting and offers protection for the cable.

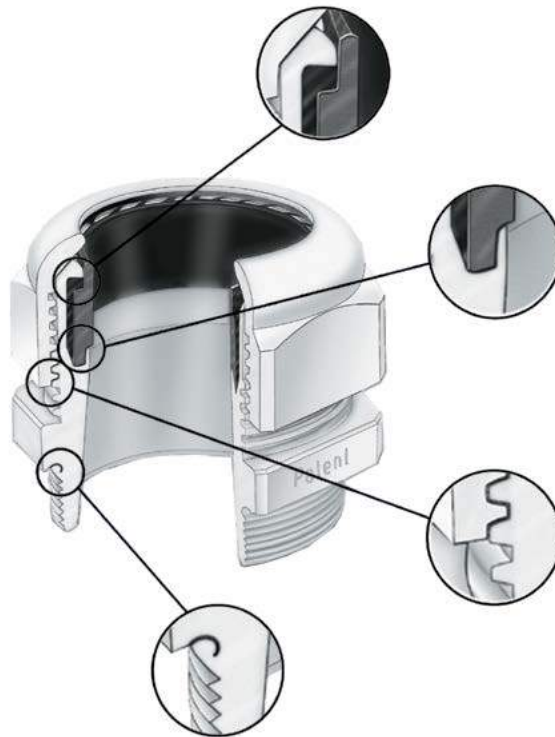

Dependable

Exceeds NEMA 4x and 6 specifications (UL tested). For submersion applications, use an O-Ring or Seal Ring between body and housing. Either tap the housing or secure in panel hole with Locking Nut.

Non-Corrosive

The Nylon strain relief cable glands are resistant to salt water, weak acids, weak alkalis, alcohol, esters, ketones, ether, gasoline, mineral, animal and vegetable oil.

Submersible

The patented recess and high performance seal guarantees NEMA 4x and 6 (IP 68) at 150 PSIG (10 BAR).

Rugged Construction

The rugged lead screw results in a dependable transmission of force between nut and body.

Liquid Tight

The concentric seal ridge and molded groove for an optional O-Ring results in a liquid tight seal between body and housing.



EMI/RFI Proof-Grounded

- Termination of the braided shield
- Strip cable jacket and braiding to different lengths
- For small diameter cables, fold the braided shield back over the cable jacket
- Insert cable into fitting until it reaches contact point
- Tighten dome nut

PG/NPT Threads - Nylon/Straight

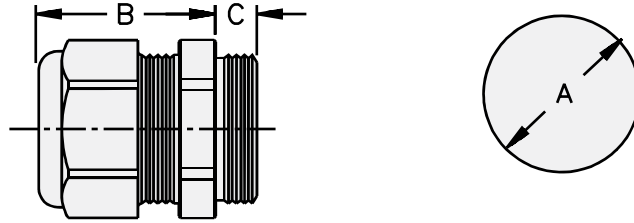

Part Number	Cable Range	Thread Type	Clearance Hole (A)	Body Length (B)	Thread Length (C)
CG-PG7STRT-NYLON 3-6.5MM	3 to 6.5 mm	PG7	12.5 mm	20 mm	8 mm
CG-PG9STRT-NYLON 4-8MM	4 to 8 mm	PG9	15.2 mm	22 mm	8 mm
CG-PG11STRT-NYLON 5-10MM	5 to 10 mm	PG11	18.5 mm	24 mm	8 mm
CG-3/8STRT-NYLON 2-6MM	2 to 6 mm	3/8" NPT	17.2 mm	22 mm	15 mm
CG-1/2STRT-NYLON 5-9MM	5 to 9 mm	1/2" NPT	21.1 mm	27 mm	13 mm
CG-1/2STRT-NYLON 10-14MM	10 to 14 mm	1/2" NPT	21.1 mm	28 mm	13 mm
CG-3/4STRT-NYLON 9-16MM	9 to 16 mm	3/4" NPT	26.7 mm	30 mm	13 mm

We reserve the right to make technical alterations without prior notice.

PG/NPT Threads - Metal/Straight

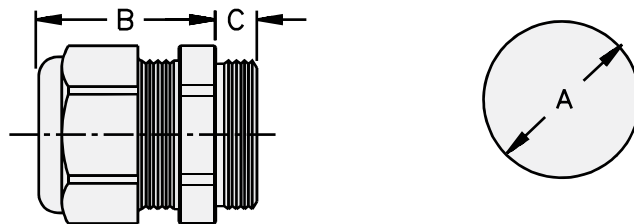

Part Number	Cable Range	Thread Type	Clearance Hole (A)	Body Length (B)	Thread Length (C)
CG-PG7STRT-METAL 3-6.5MM	3 to 6.5 mm	PG7	12.5 mm	19 mm	5 mm
CG-PG9STRT-METAL 4-8MM	4 to 8 mm	PG9	15.2 mm	21 mm	6 mm
CG-PG11STRT-METAL 5-10MM	5 to 10 mm	PG11	18.5 mm	22 mm	6 mm
CG-3/8STRT-METAL 4-8MM	4 to 8 mm	3/8" NPT	17.2 mm	21 mm	15 mm
CG-1/2STRT-METAL 6-12MM	6 to 12 mm	1/2" NPT	21.1 mm	24 mm	13 mm
CG-3/4STRT-METAL 13-18MM	13 to 18 mm	3/4" NPT	26.7 mm	25 mm	13 mm

Accessories

Connectivity Products

SHIELDED - PG/NPT Threads - Metal/Straight

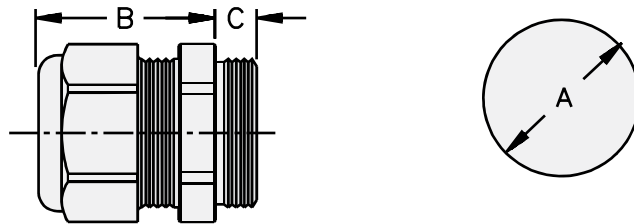

Part Number	Cable Range	Thread Type	Clearance Hole (A)	Body Length (B)	Thread Length (C)
CG-3/8STRT-SHLDMTL 4-8MM	4 to 8 mm	3/8" NPT	17.2 mm	20 mm	15 mm
CG-1/2STRT-SHLDMTL 6-12MM	6 to 12 mm	1/2" NPT	21.1 mm	22 mm	13 mm
CG-3/4STRT-SHLDMTL 9-16MM	9 to 16 mm	3/4" NPT	26.7 mm	29 mm	13 mm

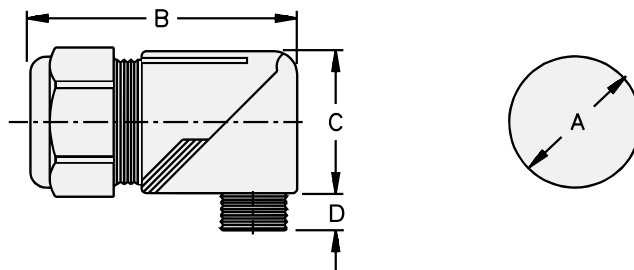

PG/NPT Threads - Nylon/Right Angle



Part Number	Cable Range	Thread Type	Clearance Hole (A)	Body Length (B)	Height (C)	Thread Length (D)
CG-PG9ANGLE-NYLON 4-8MM	4 to 8 mm	PG 9	15.2 mm	45 mm	23 mm	8 mm
CG-3/8ANGLE-NYLON 4-8MM	4 to 8 mm	3/8" NPT	17.2 mm	45 mm	23 mm	15 mm
CG-1/2ANGLE-NYLON 5-9MM	5 to 9 mm	1/2" NPT	21.1 mm	57 mm	30.5 mm	13 mm
CG-1/2ANGLE-NYLON 10-14MM	10 to 14 mm	1/2" NPT	21.1 mm	65 mm	32.5 mm	13 mm
CG-3/4ANGLE-NYLON 9-16MM	9 to 16 mm	3/4" NPT	26.7 mm	73 mm	40 mm	13 mm

We reserve the right to make technical alterations without prior notice.

Strain Relief Cord Grips

Part Number	Specifications	Application	Drawing
SRF-PG11	Nylon PG 11 threads Accepts cable diameter .200-.394" IP 68 -30 °C to +100 °C	Strain relief cord grip	
SRF-PG13.5	Nylon PG 13.5 threads Accepts cable diameter .236-.472" IP 68 -30 °C to +100 °C	Strain relief cord grip	

Snap-in Labels

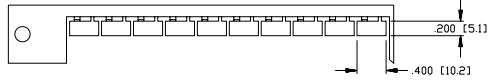
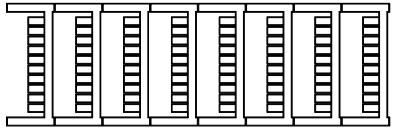
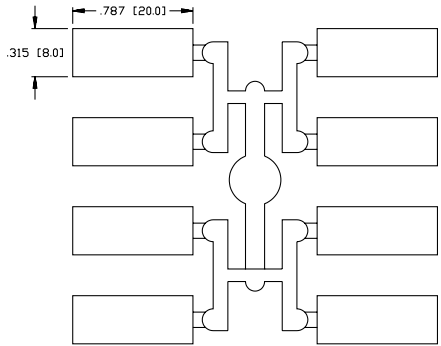
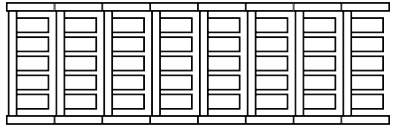
Part Number	Specifications	Application	Drawing
KS 5/10 (10/Labels)	10 white labels 5x10 mm each	Snap-in labels for VBRS and VBRK splitters and Eurofast® to Picofast® adapters and junction boxes	
Custom printed labels (Consult factory for part number)	1 sheet minimum 80 white labels, 5x10 mm each		
VZ 1 (8/labels)	8 white labels 8x20 mm each Nylon	Snap-in labels for Eurofast and Microfast® junction boxes, V*fast®	
Custom printed labels (Consult factory for part number)	1 sheet minimum 40 white labels, 8x20 mm each		

We reserve the right to make technical alterations without prior notice.

Accessories

Connectivity Products



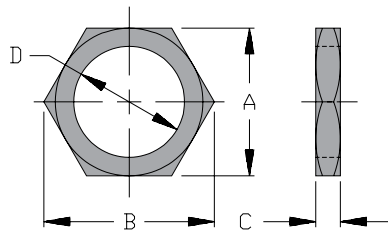

Lock Nuts

Part Number	Specifications	Application	A	B	C	D
LOCKNUT-PG 9 Metal (5/Bag)	Nickel plated brass PG 9 threads 5 per bag	Lock nut Eurofast® receptacles	0.71" 18.0 mm	0.79" 20.0 mm	0.11" 2.8 mm	PG 9
LOCKNUT-PG 13.5 Metal (5/Bag)	Nickel plated brass PG 13.5 threads 5 per bag	Lock nut Eurofast receptacles	0.90" 23.0 mm	1.00" 25.5 mm	0.12" 3.0 mm	PG 13.5
LOCKNUT 1/4-18 (10/Bag)	Nickel plated brass 1/4-18 threads 10 per bag	Lock nut Eurofast and Microfast® receptacles	0.69" 17.5 mm	0.79" 20.0 mm	0.16" 4.0 mm	1/4-18
LOCKNUT 1/2-14 Hex (10/Bag)	Die-cast Zinc ½-14 threads 10 per bag	Lock nut Minifast®, Eurofast and Microfast receptacles	0.94" 24.0 mm	1.1" 27.5 mm	0.16" 4.0 mm	1/2-14



We reserve the right to make technical alterations without prior notice.

Torque Wrench

Picture	Part Number	Specifications
<p data-bbox="386 296 440 317">Base</p>  <p data-bbox="334 638 492 659">Torque Adjuster</p>  <p data-bbox="367 968 459 989">M8 Insert</p>  <p data-bbox="362 1289 464 1310">M12 Insert</p> 	<p data-bbox="691 926 1040 947">SCREWTY M8/M12 TORQUE WRENCH</p>	<p data-bbox="1118 827 1490 877">For tightening and loosening of Eurofast® and Picofast® connectors</p> <p data-bbox="1118 911 1328 961">M8 Torque: Recommended: 0.5 Nm</p> <p data-bbox="1118 1003 1328 1054">M12 Torque: Recommended: 0.8 Nm</p>

We reserve the right to make technical alterations without prior notice.

Accessories



Connectivity Products

Braided Fiberglass Sleeving Viton Coated (Bulk)



Part Number	Specifications	Application	Features
FFV 1/4INCH BLACK 50 FOOT ROLL [†] FFV 1/4INCH BLACK (10/BAG-6IN) [†]	Viton (fluoroelastomer) coated, braided fiberglass, black 1/4" diameter -70 °C to +220 °C NEMA TF-1	Protective sleeving for insulation of cable.	Excellent chemical and solvent resistance, coating offers improved flexibility and protection throughout a wide operating temperature range.
FFV 3/8INCH BLACK 50 FOOT ROLL [†] FFV 3/8INCH BLACK (10/BAG-6IN) [†]	Viton (fluoroelastomer) coated, braided fiberglass, black 3/8" diameter -70 °C to +220 °C NEMA TF-1		
FFV 1/2INCH BLACK 50 FOOT ROLL [†] FFV 1/2INCH BLACK (10/BAG-6IN) [†]	Viton (fluoroelastomer) coated, braided fiberglass, black 1/2" diameter -70 °C to +220 °C NEMA TF-1		
FFV 5/8INCH BLACK 50 FOOT ROLL [†] FFV 5/8INCH BLACK (10/BAG-6IN) [†]	Viton (fluoroelastomer) coated, braided fiberglass, black 5/8" diameter -70 °C to +220 °C NEMA TF-1		
FFV 1INCH BLACK 50 FOOT ROLL [†] FFV 1INCH BLACK (10/BAG-6IN) [†]	Viton (fluoroelastomer) coated, braided fiberglass, black 1" diameter -70 °C to +220 °C NEMA TF-1		
FFV 1 1/2INCH BLACK 50 FOOT ROLL [†] FFV 1 1/2INCH BLACK (10/BAG-6IN) [†]	Viton (fluoroelastomer) coated, braided fiberglass, black 1 1/2" diameter -70 °C to +220 °C NEMA TF-1		

We reserve the right to make technical alterations without prior notice.

Braided Fiberglass Sleeving Acryl-Coated (Bulk)

Part Number	Specifications	Application	Features
FF 3/4INCH BLACK (10/BAG) [†] FF 3/4INCH BLACK 50 FOOT ROLL [†]	Acryl-coated braided fiberglass 3/4" diameter -70 °C to +240 °C NEMA TF-1	Protective sleeving for insulation of cable.	Excellent chemical and solvent resistance.
FF 1/2INCH BLACK (10/BAG) [†] FF 1/2INCH BLACK 50 FOOT ROLL [†]	Acryl-coated braided fiberglass 1/2" diameter -70 °C to +240 °C NEMA TF-1		

[†] Sleeving part numbers only; cordset not included.

Expandable Silicone Rubber Coated, Fiberglass Sleeving (Bulk)



We reserve the right to make technical alterations without prior notice.

Part Number	Specifications	Application	Features
FFFS WHT ID 3/8-INCH-30M[†] FFFS WHT ID 3/8-INCH (10/BAG-6IN)[†]	Fiberglass braid, silicone rubber coating, white 3/8" diameter, -55 °C to +200 °C NEMA TF-1	Expandable silicone coated fiberglass sleeving for protection of cable and coupling nut.	"Heat shrink" like fit with abrasion, moisture, cut-through chemical and weld slag resistance.
FFFS WHT ID 5/8-INCH-30M[†] FFFS WHT ID 5/8-INCH (10/BAG-6IN)[†]	Fiberglass braid, silicone rubber coating, white 5/8" diameter, -55 °C to +200 °C NEMA TF-1		
FFFS BLK ID 3/4-INCH-30M[†] FFFS BLK ID 3/4-INCH (10/BAG-6IN)[†]	Fiberglass braid, silicone rubber coating, black 3/4" diameter, -55 °C to +200 °C NEMA TF-1		
FFFS BLK ID 1-INCH-30M[†] FFFS BLK ID 1-INCH (10/BAG-6IN)[†]	Fiberglass braid, silicone rubber coating, black 1" diameter, -55 °C to +200 °C NEMA TF-1		

[†] Sleeving part numbers only; cordset not included.

Silicone Tubing (*Bulk)



Part Number	Specifications	Application	Features
ST ID 1/4-INCH-30M[†] ST ID 1/4-INCH (10/BAG-6IN)[†]	Silicone rubber tubing, translucent 1/4" diameter UL	Protective tubing for insulation of cable.	Excellent weld slag resistance.
ST ID 3/8-INCH-30M[†] ST ID 3/8-INCH (10/BAG-6IN)[†]	Silicone rubber tubing, translucent 3/8" diameter UL		
ST ID 3/8-INCH-30M[†] ST ID 3/8-INCH (10/BAG-6IN)[†]	Silicone rubber tubing, translucent 1/2" diameter UL		
ST ID 3/4-INCH-30M[†] ST ID 3/4-INCH (10/BAG-6IN)[†]	Silicone rubber tubing, translucent 3/4" diameter UL		

Add "/S1077" to end of part number to get silicone tubing assembled to pigtail or extension cordsets up to 4 meters (Picofast®, Eurofast®, Microfast® and Minifast®; 0.5 meter min. on extensions).

[†] Sleeving part numbers only; cordset not included.

Accessories

Connectivity Products

Weld Shield Sleeve - Hook and Loop Closure



Part Number	Specifications	Application	Features
FFW 1INC 2FOOT	Plain weave fiberglass, neoprene coated, black 1" Bundle OD, 3.25" circumference 4" Sleeve Width Flat, Tested to ISO 6945 -40 °C to +204 °C Temperature Resistance	Applicable sleeve for protection of cable.	Sleeve offers excellent resistance to abrasion, water, most chemicals, heat, sparks, and flame in a wide operating temperature range, while being lightweight, tough and highly flexible.
FFW 2INC 2FOOT	Plain weave fiberglass, neoprene coated, black 2" Bundle OD, 6" circumference 7.75" Sleeve Width Flat, Tested to ISO 6945 -40 °C to +204 °C Temperature Resistance		
FFW 3INC 2FOOT*	Plain weave fiberglass, neoprene coated, black 3" Bundle OD, 9.4" circumference 11" Sleeve Width Flat, Tested to ISO 6945 -40 °C to +204 °C Temperature Resistance		
FFW 4INC 2FOOT*	Plain weave fiberglass, neoprene coated, black 4" Bundle OD, 12.5" circumference 14" Sleeve Width Flat, Tested to ISO 6945 -40 °C to +204 °C Temperature Resistance		
FFW 5INC 2FOOT	Plain weave fiberglass, neoprene coated, black 5" Bundle OD, 15.75" circumference 17.25" Sleeve Width Flat, Tested to ISO 6945 -40 °C to +204 °C Temperature Resistance		
FFW 6INC 2FOOT	Plain weave fiberglass, neoprene coated, black 6" Bundle OD, 18.8" circumference 20.375" Sleeve Width Flat, Tested to ISO 6945 -40 °C to +204 °C Temperature Resistance		
FFW 7INC 2FOOT	Plain weave fiberglass, neoprene coated, black 7" Bundle OD, 22" circumference 23.5" Sleeve Width Flat, Tested to ISO 6945 -40 °C to +204 °C Temperature Resistance		
FFW 8INC 2FOOT	Plain weave fiberglass, neoprene coated, black 8" Bundle OD, 25.125" circumference 26.625" Sleeve Width Flat, Tested to ISO 6945 -40 °C to +204 °C Temperature Resistance		

We reserve the right to make technical alterations without prior notice.

* 25 foot spool also available.

Weld Seal Tape



Part Number	Specifications	Application	Features
FST 1IN 12YARDS	Silicone rubber, Clear 1" width, 12 yard length, -40 °C to +204 °C	Applicable clear tape protecting open areas between silicone tubing and mold.	Tape offers excellent resistance to water, most chemicals, heat, sparks, and flame in a wide operating temperature range, while being lightweight, and highly flexible.

Part Number Keys	V2
2-Branch Compact	V6
2-Branch Standard	V10
M12 to M8 2-Branch	V20
M12 to Valve Plug 2-Branch	V22
4-Branch Standard	V24
2-Branch M8 Compact	V36
4-Branch M8	V44
M12 to M8 Adapters	V48
M12 2-Branch Molded Splitters	V50

Features

- Multiple body styles
- M12 and M8 connectors
- 2 and 4 branch products
- LED options
- Integral connectors or cables
- Standard, parallel and series wired



Splitters

2-Branch Splitter Part Number Key

Part Number Keys are to assist in IDENTIFICATION ONLY. Consult factory for catalog items not identified.

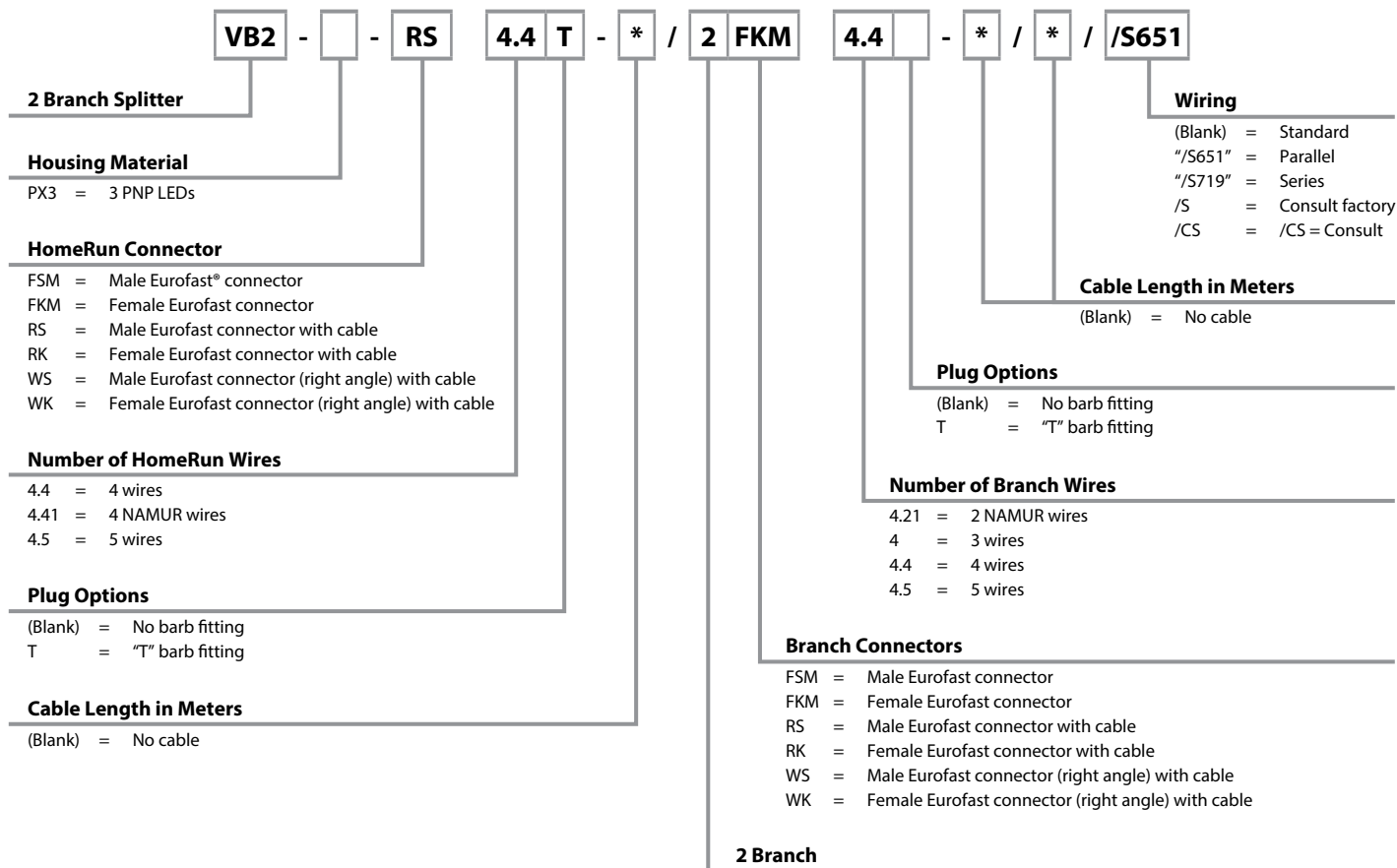

3 and 4 Branch Splitter Part Number Key

Part Number Keys are to assist in IDENTIFICATION ONLY. Consult factory for catalog items not identified.

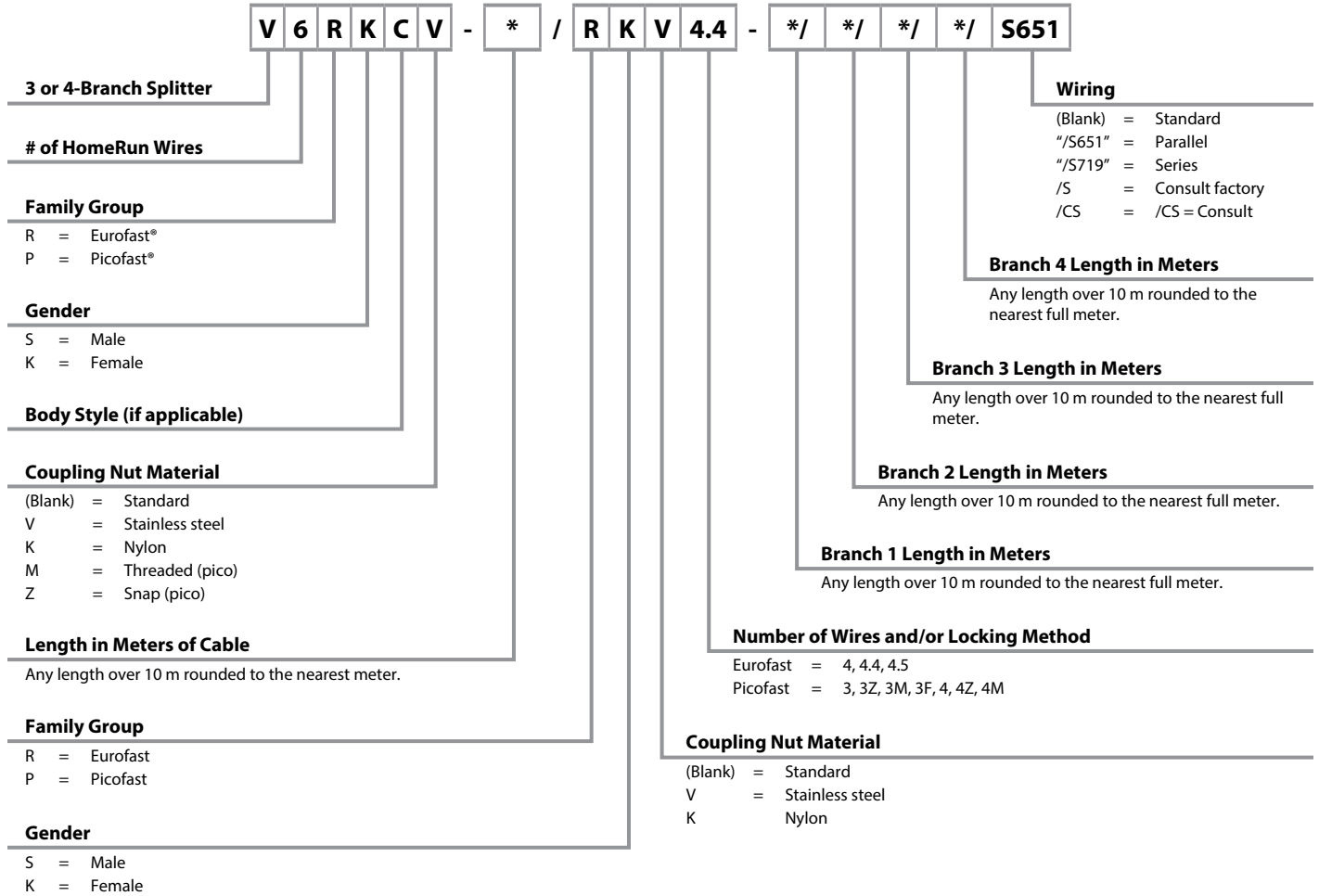

Splitters

2-Branch Compact Splitter Part Number Key

Part Number Keys are to assist in IDENTIFICATION ONLY. Consult factory for catalog items not identified.

YBZ2 - [] - FSM 4.5 / 2 FK 4.5 - * / * / /S651

Compact 2-Branch Splitter

YBZ2 = M12 Eurofast®
YP2 = M8 Picofast®

Housing Material

PX3 = 3 PNP LEDs
PX2 = 2 PNP LEDs

HomeRun Connector

FSM = Male Eurofast
PSG = Male Picofast with cable
RS = Male Eurofast with cable
MFS = Male Picofast

Number of HomeRun Wires

4.4 = 4 wires
4.5 = 5 wires
4M = 4 wires
3M = 3 wires
6M = 6 wires

2 Branch

Wiring

(Blank) = Standard
"/S651" = Parallel

Cable Length in Meters

(Blank) = No cable

Plug Options

(Blank) = No barb fitting
T = "T" barb fitting (M12 Eurofast)

Number of Branch Wires

4.5 = 5 wires
3M = 3 wires
4 = 3 wires
4.4 = 4.4 wires
4M = 4 wires

Branch Connectors

FK = Female Eurofast connector
PKG = Female Picofast connector with cable
RK = Female Eurofast connector with cable
MFK = Female Picofast connector
PSG = Male Picofast connector with cable

2-Branch (VBR/S/K) Splitter Part Number Key

Part Number Keys are to assist in IDENTIFICATION ONLY. Consult factory for catalog items not identified.

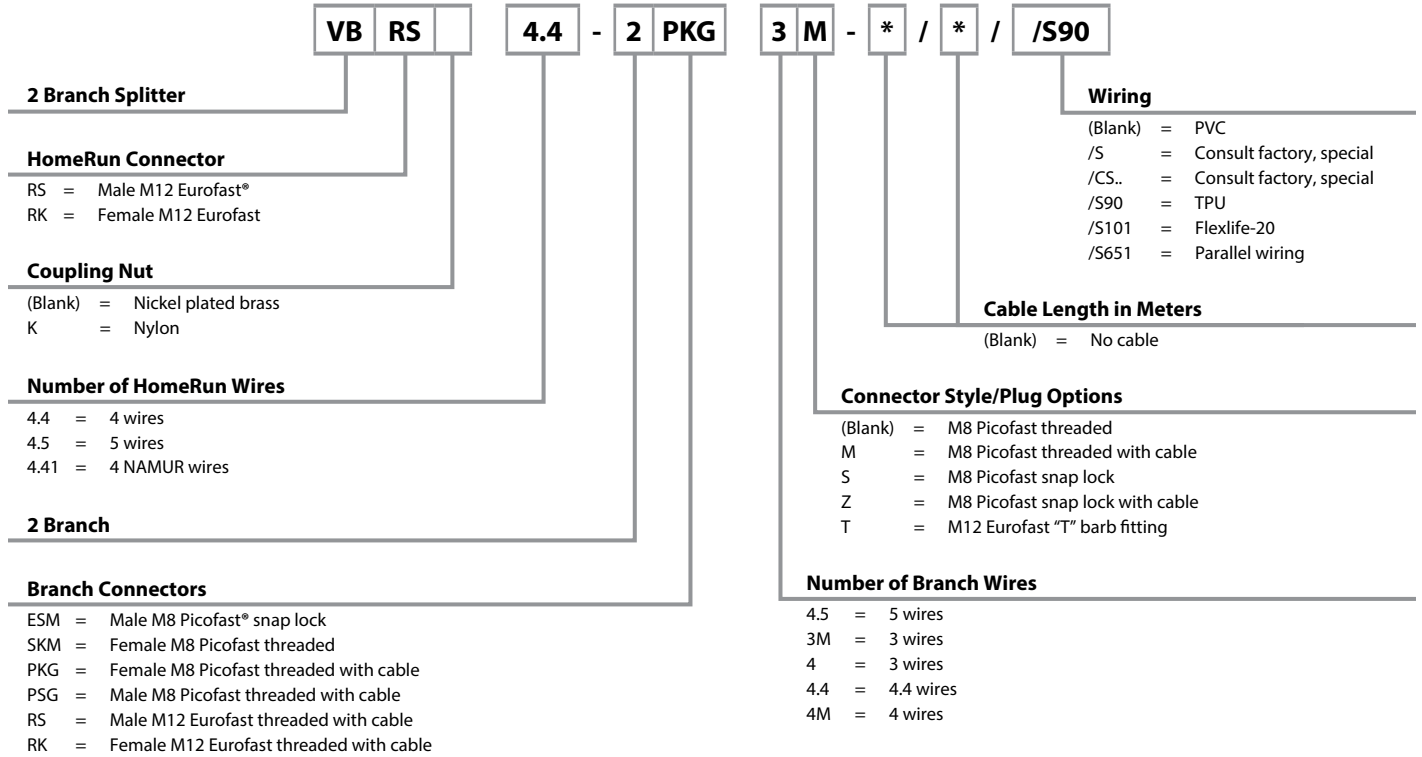

Splitters

M12 Eurofast® 2-Branch Compact Splitters Eurofast Trunk Connector

- Combine two Sensors into one Cable
- For use on cylinders and other Dual-Input applications
- Tough TPU Construction



Housing	Part Number	Features	Wiring Diagram
	YBZ2-FSM4.4/2FK4	250 V, 4 A, 2 Eurofast branches, 3-wire & 1 Eurofast trunk, 4-wire	Standard
	YBZ2-FSM4.4/2FK4.4/S651	250 V, 4 A, 2 Eurofast branches, 4-wire & 1 Eurofast trunk, 4-wire	Parallel 4-wire
	YBZ2-FSM4.5/2FK4.5/S651	250 V, 4 A, 2 Eurofast branches, 5-wire & 1 Eurofast trunk, 5-wire	Parallel 5-wire
	YBZ2-PX3-FSM4.4/2FK4	10-30 VDC, 4 A, 2 Eurofast branches, 3-wire & 1 Eurofast trunk, 4-wire	LED
	YBZ2-FSM4.4/2RK4T-*/*	250 V, 4 A, RK 4T = Grey PVC, 5.1 mm OD, 3x20 AWG, 2 Eurofast branches, 3-wire & 1 Eurofast trunk, 4-wire	Standard
	YBZ2-FSM4.4/2RK4.4T-*/*/S651	250 V, 4 A, RK 4.4T = Grey PVC, 5.1 mm OD, 4x22 AWG, 2 Eurofast branches, 4-wire & 1 Eurofast trunk, 4-wire	Parallel 4-wire
	YBZ2-FSM4.4/2PKG3M-*/*	125 V, 4 A, PKG 3M = Yellow PVC, 4.4 mm OD, 3x24 AWG, 2 Picofast® branches, 3-wire & 1 Eurofast trunk, 4-wire	Standard

We reserve the right to make technical alterations without prior notice.

* Length in meters.

Wiring Diagrams

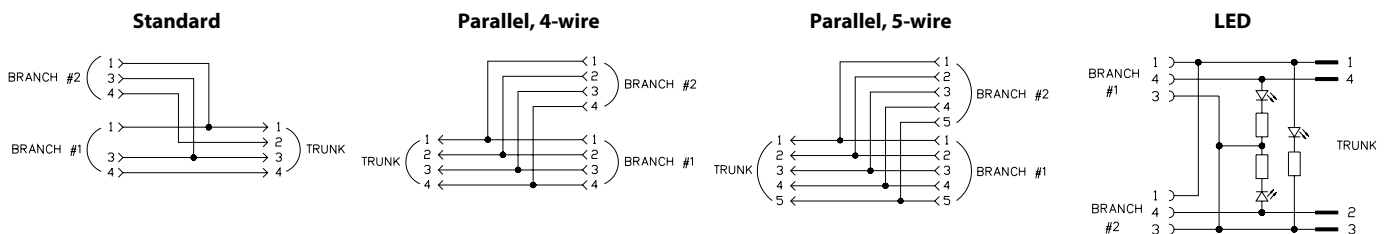

M12 Eurofast® 2-Branch Compact Splitters Eurofast Trunk Connector

Specifications

Junction Body:	Oil resistant yellow TPU	Coupling Nuts:	Nickel plated brass
Connector:	Oil resistant TPU body material, Nylon or TPU contact carrier	Cable:	See table
Contacts:	Gold plated brass	Temperature:	-40 °C to +105 °C (-40 °F to +221 °F)
		Protection:	NEMA 1, 3, 4, 6P and IEC IP68

Cable Length: Branches - nominal 0.3 meters. Other lengths available by request - consult factory.
Cable Options: Standard cable jacket - grey/yellow PVC. TPU and other jackets available by request - consult factory.
Connector Options: (for legs with cable) Stainless steel coupling nut add "V" to part number (PKG to PKGV, PSG to PSGV, RK to RKV).
Notes: Mounting hole accepts #4 screw.

We reserve the right to make technical alterations without prior notice.

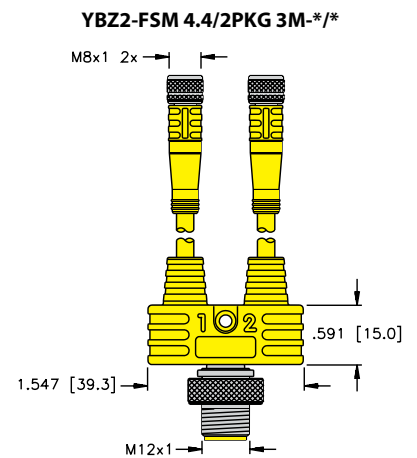
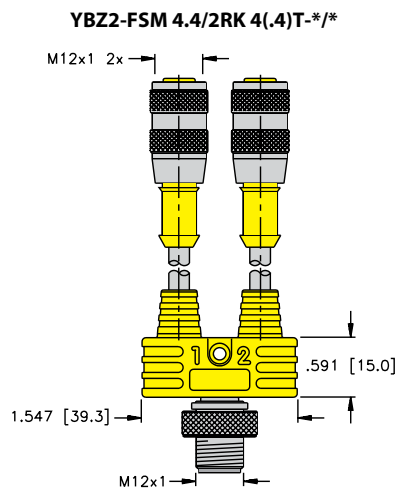
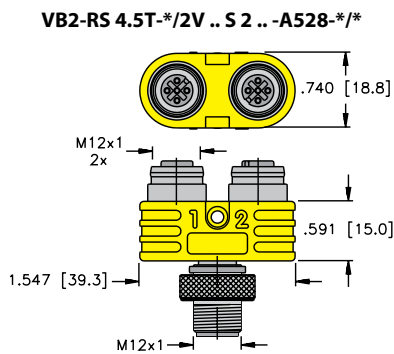

Pinouts

4-Pin Eurofast	5-Pin Eurofast	3-Pin Picofast®	4-Pin Eurofast	5-Pin Eurofast
Female			Male	

Splitters

M12 Eurofast® 2-Branch Compact Splitters, Trunk and Branch Extensions

- Combine two sensors into one Cable
- For use on Cylinders and other Dual-Input applications
- Tough TPU Construction



Housing	Part Number	Features	Wiring Diagram
	YBZ2-RS4.4T-*/2RK4T-*/*	250 V, 4 A, RS 4.4T = Grey PVC, 5.1 mm OD, 4x22 AWG, RK 4T = Grey PVC, 5.1 mm OD, 3x20 AWG, 2 Eurofast branches, 3-wire & 1 Eurofast trunk, 4-wire	Standard
	YBZ2-RS4.4T-*/2RK4.4T-*/*/S651	250 V, 4 A, RS 4.4T & RK 4.4T = Grey PVC, 5.1 mm OD, 4x22 AWG, 2 Eurofast branches, 4-wire & 1 Eurofast trunk, 4-wire	Parallel 4-wire
	YBZ2-RS4.5T-*/2RK4.5T-*/*/S651	250 V, 4 A, RK 4.5T & RS 4.5T = Grey PVC, 5.7 mm OD, 5x22 AWG, 2 Eurofast branches, 5-wire & 1 Eurofast trunk, 5-wire	Parallel 5-wire
	YBZ2-PSG4M-*/2PKG3M-*/*	125 V, 2 A, PSG 4M = Yellow PVC, 4.4 mm OD, 4x26 AWG, PKG 3M = Yellow PVC, 4.4 mm OD, 3x24 AWG, 2 Picofast® branches, 3-wire & 1 Picofast trunk, 4-wire	Standard
	YBZ2-PSG3M-*/2PKG3M-*/*/S651	125 V, 4 A, PSG 3M & PKG 3M = Yellow PVC, 4.4 mm OD, 3x24 AWG, 2 Picofast branches, 3-wire & 1 Picofast trunk, 3-wire	Parallel 3-wire
	YBZ2-RS4.5T-*/2VAS22-A653-*/*	220 V, 4 A, RS 4.5T = Grey PVC, 5.1 mm OD, 4x22 AWG, VAS22 = Grey PVC, 6.2 mm OD, 3x18 AWG, 2 valve branches, 3-wire & 1 Eurofast trunk, 4-wire	Standard valve

* Length in meters.

We reserve the right to make technical alterations without prior notice.

Wiring Diagrams

Standard

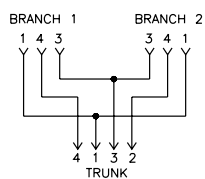

Parallel, 3-wire

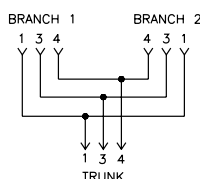

Standard, valve

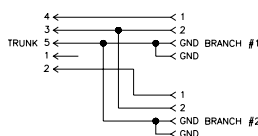

Parallel, 4-wire

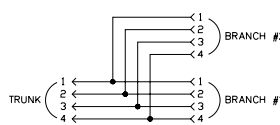

Parallel, 5-wire

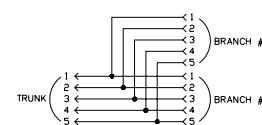

M12 Eurofast® 2-Branch Compact Splitters, Trunk and Branch Extensions

Specifications

Junction Body:	Oil resistant yellow TPU	Coupling Nuts:	Nickel plated brass
Connector:	Oil resistant TPU body material, Nylon or TPU contact carrier	Cable:	See table
Contacts:	Gold plated brass	Temperature:	-40 °C to +105 °C (-40 °F to +221 °F)
		Protection:	NEMA 1, 3, 4, 6P and IEC IP68

- Cable Length:** Branches - nominal 0.3 meters. Other lengths available by request - consult factory.
- Cable Options:** Standard cable jacket - grey/yellow PVC. TPU and other jackets available by request - consult factory.
- Connector Options:** (for legs with cable)
Stainless steel coupling nut add "V" to part number (PKG to PKGV, PSG to PSGV, RK to RKV).
- Notes:** Mounting hole accepts #4 screw.

YBZ2-RS 4.4(5)T-*/2RK 4(.4)(.5)T-*/*

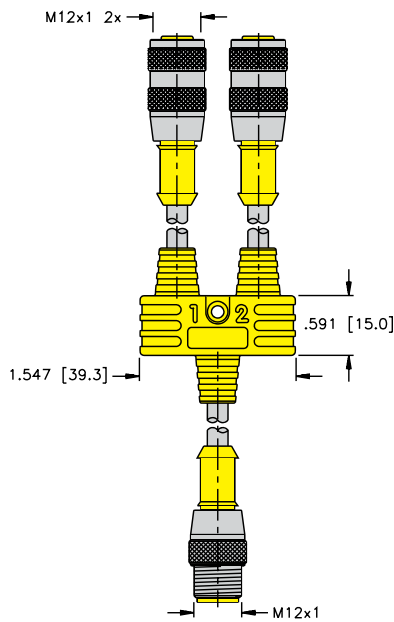

YBZ2-PSG 3(4)M-*/2PKG 3M-*/*

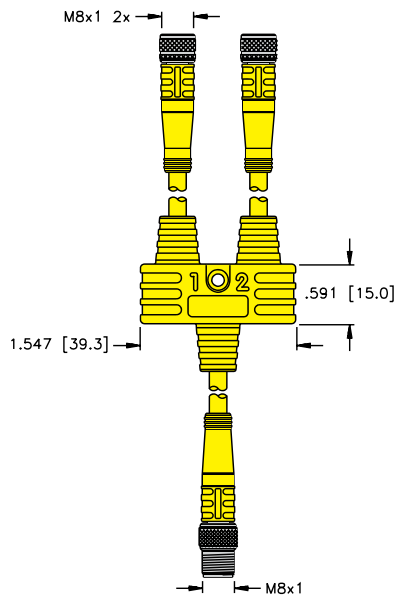

YBZ2-RS 4.5T-*/2VAS22-A653-*/*

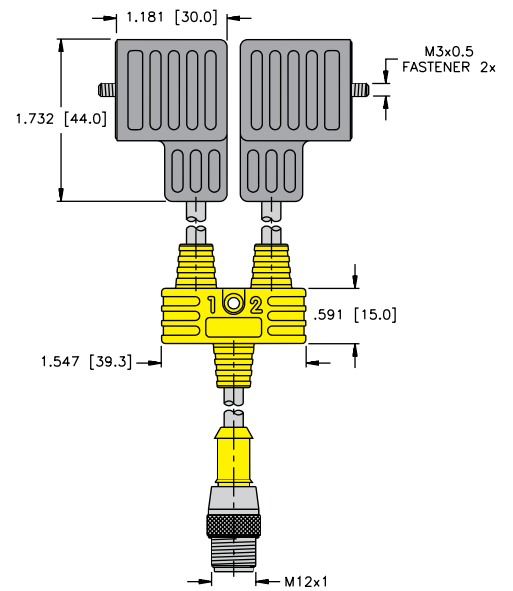

We reserve the right to make technical alterations without prior notice.

Pinouts

4-Pin Eurofast	5-Pin Eurofast	3-Pin Picofast®	3-Pin Picofast	4-Pin Picofast	5-Pin Eurofast
Female			Male		

Splitters

Eurofast® 2-Branch Splitters, Standard and LED Wiring

- Combine two Sensors into one Cable
- For use on Cylinders and other Dual-Input applications
- Tough TPU Construction
- For 3-wire DC Sensors or Switches



Housing	Part Number	Features	Wiring Diagram
	VB2-FSM 4.4/2FKM 4	250 V, 4.0 A, combine two sensors into one cable	Standard
	VB2-RS 4.4T-*/2FKM 4	250 V, 4.0 A, RS 4.4T = Grey PVC, 5.1 mm OD, 4x22 AWG, combine two sensors into one cable	
	VB2-FSM 4.4/2RK 4T-*/**	250 V, 4.0 A, Grey PVC, 5.1 mm OD, RK 4T - 3x20 AWG, combine two sensors into one cable	
	VB2-RS 4.4T-*/2RK 4T-*/**	250 V, 4.0 A, Grey PVC, 5.1 mm OD, RK 4T - 3x20 AWG, RS 4.4T - 4x22 AWG, combine two sensors into one cable	
	VB2P3-FSM 4.4/2FKM 4	10-30 VDC, 4.0 A, combine two sensors into one cable; 3 LEDs, 2 signals, PNP, 1 power	LED
	VB2P3-RS 4.4T-*/2FKM 4	10-30 VDC, 4.0 A, RS 4.4T = Grey PVC, 5.1 mm OD, 4x22 AWG, combine two sensors into one cable; 3 LEDs, 2 signals, PNP, 1 power	
	VB2P3-FSM 4.4/2RK 4T-*/**	10-30 VDC, 4.0 A, Grey PVC, 5.1 mm OD, RK 4T - 3x20 AWG, combine two sensors into one cable; 3 LEDs, 2 signals, PNP, 1 power	
	VB2P3-RS 4.4T-*/2RK 4T-*/**	10-30 VDC, 4.0 A, Grey PVC, 5.1 mm OD, RK 4T - 3x20 AWG, RS 4.4T - 4x22 AWG, combine two sensors into one cable; 3 LEDs, 2 signals, PNP, 1 power	

We reserve the right to make technical alterations without prior notice.

Wiring Diagrams

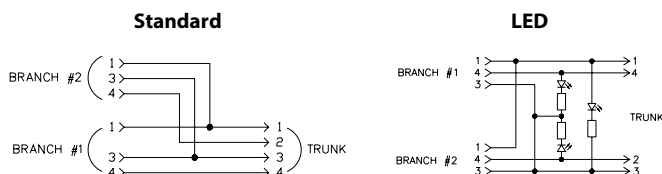

Specifications

Junction Body: Oil resistant yellow TPU (non-LED)
Translucent black TPU (LED)

Coupling Nuts: Nickel plated brass

Connector: Oil resistant TPU body material, Nylon or TPU contact carrier

Cable: See table

Contacts: Gold plated brass

Temperature: -40 °C to +105 °C (-40 °F to +221 °F)

Protection: IEC IP67

Cable Length: Trunk - nominal 1 meter. Branches - nominal 0.3 meters. Other lengths available by request - consult factory.

Cable Options: Standard cable jacket - grey PVC. TPU and other jackets available by request - consult factory.

Connector Options: (for legs with cable)

Stainless steel coupling nut add "V" to part number (RS to RSV, RK to RKV).

Nylon coupling nut add "K" to part number (RS to RSK, RK to RKK).

Right angle connectors, change part number (RS to WS, RK to WK).

Notes: Mounting hole accepts #8 screw.

VB2-RS 4.4T-*/2RK 4T-*/*
VB2-PX3-RS 4.4T/2RK 4T-*/*

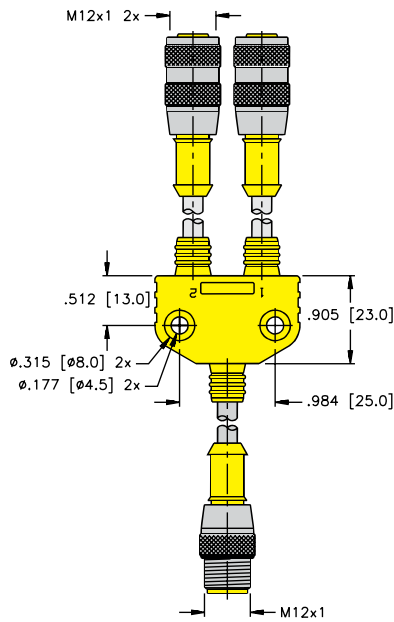

VB2-RS 4.4T-*/2FKM 4
VB2-PX3-RS 4.4T-*/2FKM 4

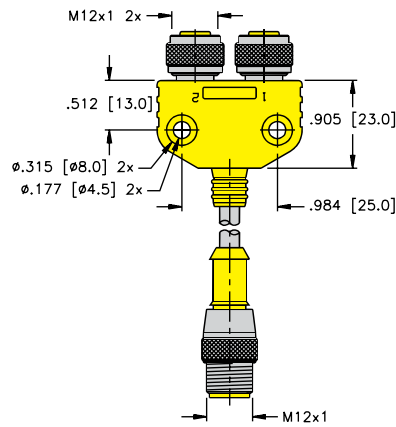

VB2-FSM 4.4/2RK 4T-*/*
VB2-PX3-FSM 4.4/2RK 4T-*/*

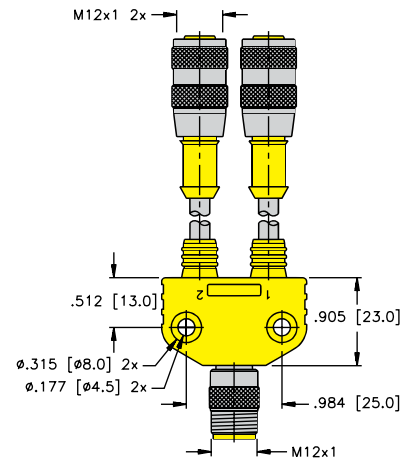

VB2-FSM 4.4/2FKM 4
VB2-PX3-FSM 4.4/2FKM 4

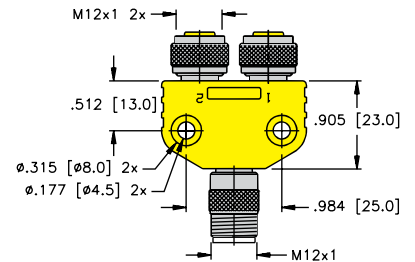

We reserve the right to make technical alterations without prior notice.

Pinouts

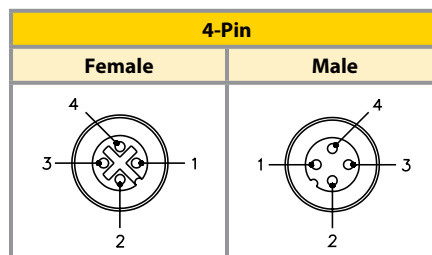

Splitters

M12 Eurofast® 2-Branch Splitters, Parallel Wiring, Shielded Option

- For use on Photoelectric Controls, Power Distribution, and other Dual-Input applications
- Tough TPU Construction



Housing	Part Number	Features	Wiring Diagram
	VB2-FSM 4.4/2FKM 4.4/S651	250 V, 4.0 A, parallel wired, 4 conductor	Parallel
	VB2-RS 4.4T-*/2FKM 4.4/S651	250 V, 4.0 A, RS 4.4T = Grey PVC, 5.1 mm OD, 4x22 AWG, parallel wired, 4 conductor	Parallel
	VB2-FSM 4.4/2RK 4.4T-*/S651	250 V, 4.0 A, RK 4.4T = Grey PVC, 5.1 mm OD, 4x22 AWG, parallel wired, 4 conductor	Parallel
	VB2-RS 4.4T-*/2RK 4.4T-*/S651	250 V, 4.0 A, Grey PVC, 5.1 mm OD, 4x22 AWG, parallel wired, 4 conductor	Parallel
	VB2-FSM 4.5/2FKM 4.5/S651	250 V, 4.0 A, parallel wired, 5 conductor	Parallel
	VB2-FSMS 4.5/2FKMS 4.5/S651	250 V, 4.0 A, parallel wired, Shielded, 5 conductor	Parallel, Shielded
	VB2-RS 4.5T-*/2FKM 4.5/S651	250 V, 4.0 A, RS 4.5T = Grey PVC, 5.7 mm OD, 5x22 AWG, parallel wired, 5 conductor	Parallel
	VB2-FSM 4.5/2RK 4.5T-*/S651	250 V, 4.0 A, RK 4.5T = Grey PVC, 5.7 mm OD, 5x22 AWG, parallel wired, 5 conductor	Parallel
	VB2-RS 4.5T-*/2RK 4.5T-*/S651	250 V, 4.0 A, Grey PVC, 5.7 mm OD, 5x22 AWG, parallel wired, 5 conductor	Parallel
	VB2-FKMS 4.5/2FSMS 4.5/S651	250 V, 4.0 A, parallel wired, shielded, 5 conductor	Parallel, Shielded

We reserve the right to make technical alterations without prior notice.

Wiring Diagrams

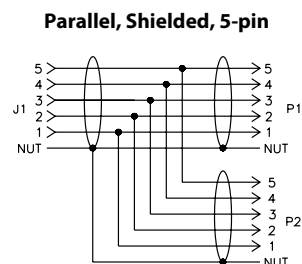
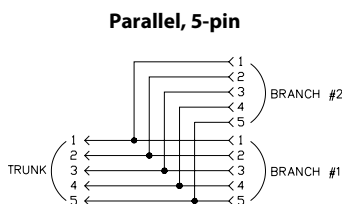
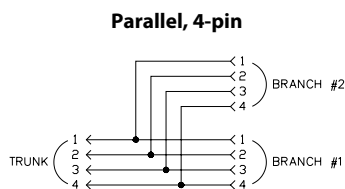

M12 Eurofast® 2-Branch Splitters, Parallel Wiring, Shielded Option

Specifications

Junction Body:	Oil resistant yellow TPU	Coupling Nuts:	Nickel plated brass
Connector:	Oil resistant TPU body material, Nylon or TPU contact carrier	Cable:	See table
Contacts:	Gold plated brass	Temperature:	-40 °C to +105 °C (-40 °F to +221 °F)
		Protection:	IEC IP67, IEC IP60 (shielded)

Cable Length: Trunk - nominal 1 meter. Branches - nominal 0.3 meters. Other lengths available by request - consult factory.

Cable Options: Standard cable jacket - grey PVC. TPU and other jackets available by request - consult factory.

Connector Options: (for legs with cable)
 Stainless steel coupling nut add "V" to part number (RS to RSV, RK to RKV).
 Nylon coupling nut add "K" to part number (RS to RSK, RK to RKK).
 Right angle connectors, change part number (RS to WS, RK to WK).

Notes: Mounting holes accept #8 screw.

We reserve the right to make technical alterations without prior notice.

VB2-RS 4.4(5)T-*/2RK 4.4(5)T-*/S651

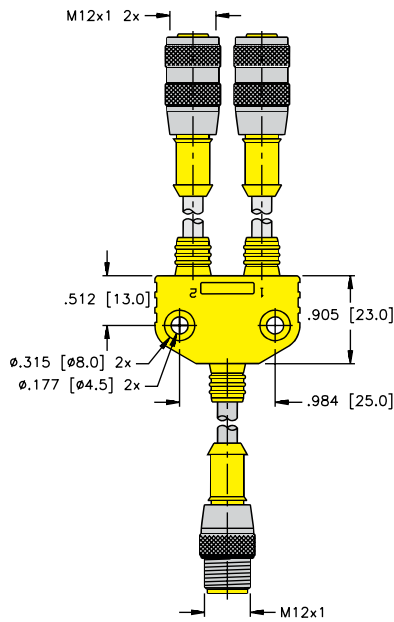

VB2-FSM 4.4(5)/2RK 4.4(5)T-*/S651

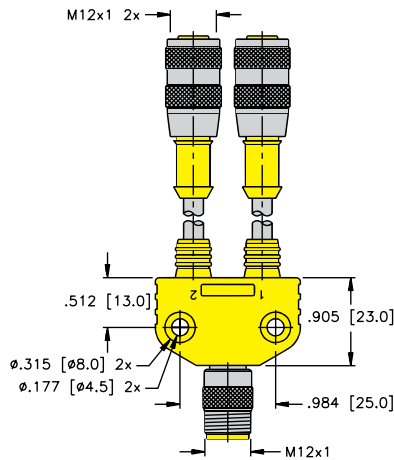

VB2-RS 4.4(5)T-*/2FKM 4.4(5)/S651

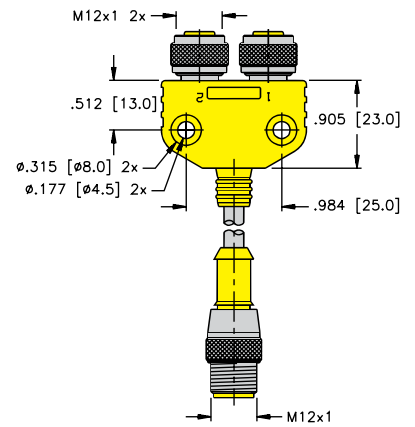

VB2-FSM(S) 4.4(5)/2FKM(S) 4.4(5)/S651

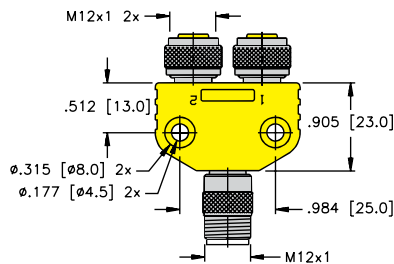

VB2-FKMS 4.5/2FSMS 4.5/S651

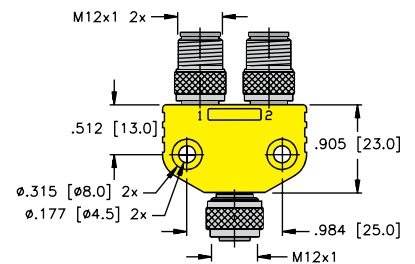

Pinout

4-Pin	5-Pin	4-Pin	5-Pin
Female		Male	

Splitters

M12 Eurofast® 2-Branch Splitters, Series Wiring

- Combine two Sensors into one Cable
- Series Wired
- Tough TPU Construction
- For 3-wire DC Sensors or Switches



Housing	Part Number	Features	Wiring Diagram
	VB2-FSM 4.4/2FKM 4/S719	250 V, 4.0 A, series wired for AND function (PNP signals)	Series
	VB2-RS 4.4T-*/2FKM 4/S719	250 V, 4.0 A, RS 4.4T = Grey PVC, 5.1 mm OD, 4x22 AWG, series wired for AND function (PNP signals)	
	VB2-FSM 4.4/2RK 4T-*/*/S719	250 V, 4.0 A, RK 4T = Grey PVC, 5.1 mm OD, 3x20 AWG, series wired for AND function (PNP signals)	
	VB2-RS 4.4T-*/2RK 4T-*/*/S719	250 V, 4.0 A, Grey PVC, 5.1 mm OD, RK 4T - 3x20 AWG, RS 4.4T - 4x22 AWG, series wired for AND function (PNP signals)	

* Length in meters.

We reserve the right to make technical alterations without prior notice.

Wiring Diagrams

Series

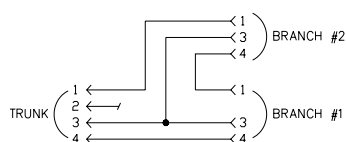

M12 Eurofast® 2-Branch Splitters, Series Wiring

Specifications

Junction Body:	Oil resistant yellow TPU	Coupling Nuts:	Nickel plated brass
Connector:	Oil resistant TPU body material, Nylon or TPU contact carrier	Cable:	See table
Contacts:	Gold plated brass	Temperature:	-40 °C to +105 °C (-40 °F to +221 °F)
		Protection:	IEC IP67

Cable Length: Trunk - nominal 1 meter. Branches - nominal 0.3 meters. Other lengths available by request - consult factory.

Cable Options: Standard cable jacket - grey PVC. TPU and other jackets available by request - consult factory.

Connector Options: (for legs with cable)

Stainless steel coupling nut add "V" to part number (RS to RSV, RK to RKV).

Nylon coupling nut add "K" to part number (RS to RSK, RK to RKK).

Right angle connectors, change part number (RS to WS, RK to WK).

Notes: Mounting holes accept #8 screw.

VB2-RS 4.4T-*/2RK 4T-*/S719

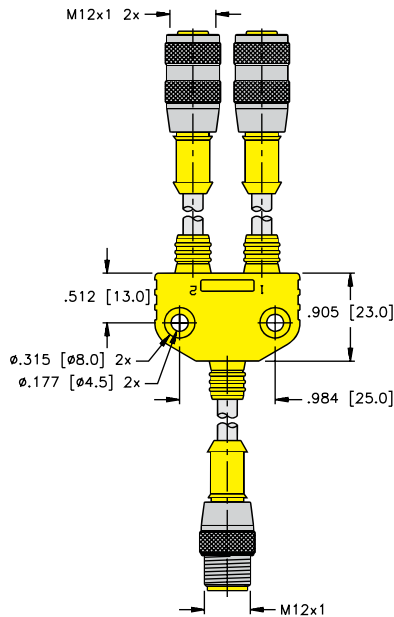

VB2-FSM 4.4/2RK 4T-*/S719

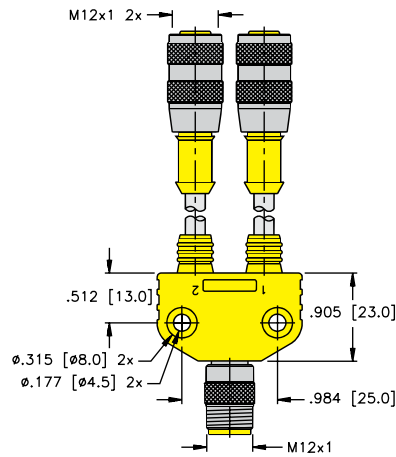

VB2-RS 4.4T-*/2FKM 4/S719

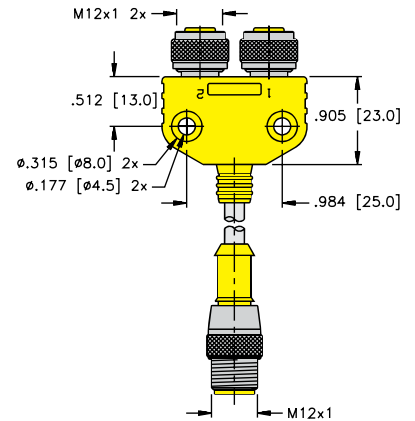

VB2-FSM 4.4/2FKM 4/S719

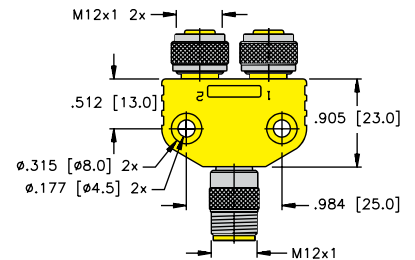

We reserve the right to make technical alterations without prior notice.

Pinouts

4-Pin Female	4-Pin Male

Splitters

M12 Eurofast® 2-Branch Splitters, NAMUR Wiring

- Combine two NAMUR Sensors into one Cable
- Tough TPU Construction
- For use with NAMUR Junction Boxes



Housing	Part Number	Features	Wiring Diagram
	VB2-FSM 4.41/2FKM 4.21	250 V, 4.0 A, combine two NAMUR sensors into one cable	NAMUR
	VB2-RS 4.41T-*/2FKM 4.21	250 V, 4.0 A, RS 4.41T = Blue PVC, 5.1 mm OD, 4x22 AWG, combine two NAMUR sensors into one cable	
	VB2-FSM 4.41/2RK 4.21T-*/*/	250 V, 4.0 A, RK 4.21T = Blue PVC, 5.1 mm OD, 2x20 AWG, combine two NAMUR sensors into one cable	
	VB2-RS 4.41T-*/2RK 4.21T-*/*/	250 V, 4.0 A, Blue PVC, 5.1 mm OD, RK 4.21T – 2x20 AWG, RS 4.41T – 4x22 AWG, combine two NAMUR sensors into one cable	

* Length in meters.

We reserve the right to make technical alterations without prior notice.

Namur Wiring Diagram

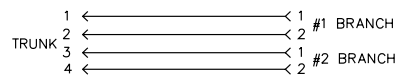

M12 Eurofast® 2-Branch Splitters, NAMUR Wiring

Specifications

Junction Body:	Oil resistant yellow TPU	Coupling Nuts:	Nickel plated brass
Connector:	Oil resistant TPU body material, Nylon or TPU contact carrier	Cable:	See table
Contacts:	Gold plated brass	Temperature:	-40 °C to +105 °C (-40 °F to +221 °F)
		Protection:	IEC IP67

Cable Length: Trunk - nominal 1 meter. Branches - nominal 0.3 meters. Other lengths available by request - consult factory.

Connector Options: (for legs with cable)
 Stainless steel coupling nut add "V" to part number (RS to RSV, RK to RKV).
 Nylon coupling nut add "K" to part number (RS to RSK, RK to RKK).
 Right angle connectors, change part number (RS to WS, RK to WK).

Notes: Mounting holes accept #8 screw.

We reserve the right to make technical alterations without prior notice.

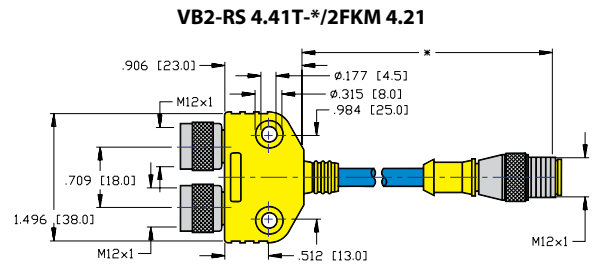
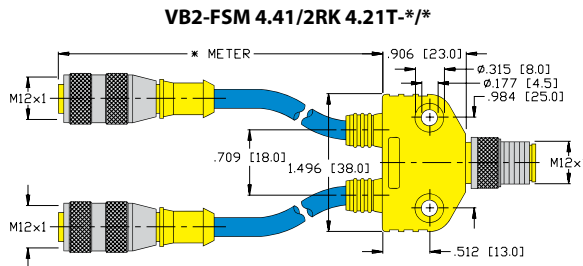
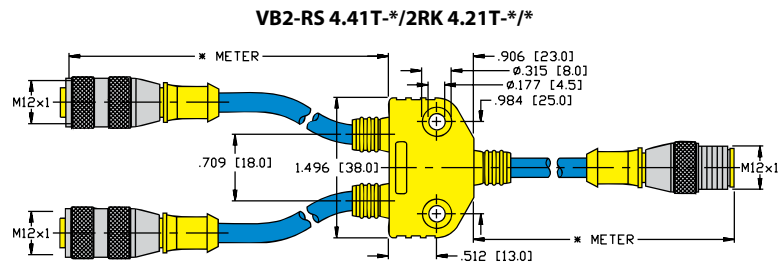
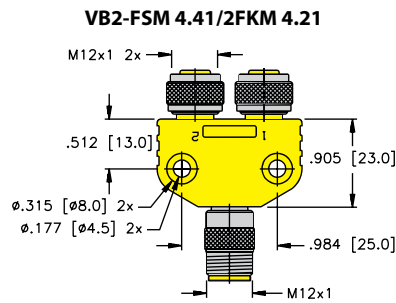

Pinouts

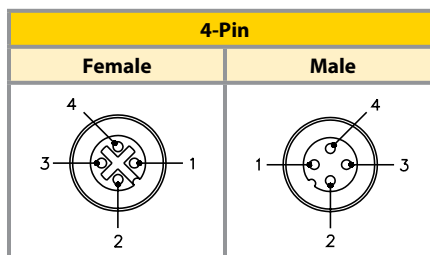

Splitters

M12 Eurofast® 2-Branch Splitters, NAMUR Wiring

- Combine two NAMUR Sensors into one Cable
- Eurofast Connection features Anti-Vibration Coupling Nut (main leg only)
- Tough TPU Body resists Oil and Abrasion
- Compact size saves space



Housing	Part Number	Features	Wiring Diagram
	VBRS 4.41-2RK 4.21T-*/**	250 V, 4.0 A, 2x20 AWG, Blue PVC, 5.1 mm OD, combine two NAMUR sensors into one cable. Connects directly to Eurofast junction box.	NAMUR

* Length in meters.
To add mounting hole, add /S857 to the end of the part number.

We reserve the right to make technical alterations without prior notice.

Namur Wiring Diagram

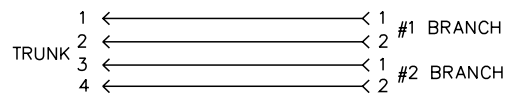

M12 Eurofast® 2-Branch Splitters, NAMUR Wiring

Specifications

Junction Body:	Oil resistant yellow TPU	Cable:	See table
Connector:	Oil resistant TPU body material, Nylon or TPU contact carrier	Temperature:	-40 °C to +105 °C (-40 °F to +221 °F)
Contacts:	Gold plated brass, machined from solid stock	Protection:	NEMA 1, 3, 4, 6P and IEC IP67
Coupling Nuts:	Nickel plated brass	Accessories:	KS 5/10 labels 2 of each included

Cable Length: Branches - nominal 0.3 meters. Other lengths available by request - consult factory.

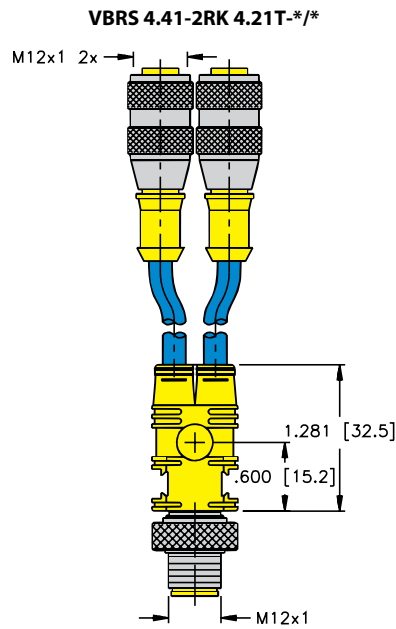

We reserve the right to make technical alterations without prior notice.

Pinouts

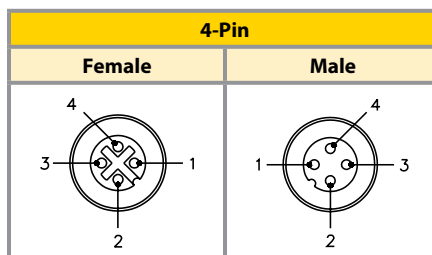

Splitters

M12 Eurofast® and M8 Picofast® 2-Branch Molded Splitters

- Combine two Picofast or Eurofast Connections into one Eurofast Receptacle
- Eurofast Connection features Anti-vibration Coupling Nut (main leg only)
- Compact size saves space
- Tough TPU Body resists Oil and Abrasion



Housing	Part Number	Features	Wiring Diagram
	VBRK 4.4-2ESM 3S	60 VAC/75 VDC, 4.0 A, for sensors with complementary outputs, splits signals. Branches have snap lock	Diagram A
	VBRS 4.4-2SKM 3	60 VAC/75 VDC, 4.0 A, combine two sensors into one cable. Connects directly to Eurofast junction box. Branches have threaded coupling nut	Diagram B
	VBRS 4.4-2PKG 3M-*/**	60 VAC/75 VDC, 4.0 A, 3x24 AWG, Yellow PVC, 4.4 mm OD, combine two sensors into one cable. Connects directly to Eurofast junction box. Branches have threaded coupling nut	Diagram B
	VBRS 4.4-2PKG 3Z-*/**	60 VAC/75 VDC, 4.0 A, 3x24 AWG, Yellow PVC, 4.4 mm OD, combine two sensors into one cable. Connects directly to Eurofast junction box. Branches have snap lock	Diagram B
	VBRS 4.4-2RK 4T-*/**	250 V, 4.0 A, 3x20 AWG, Grey PVC, 5.1 mm OD, combine two sensors into one cable. Connects directly to Eurofast junction box	Diagram B

* Length in meters.
To add mounting hole, add /S857 to the end of the part number.

We reserve the right to make technical alterations without prior notice.

Wiring Diagrams

Diagram A

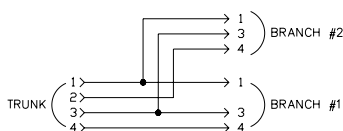
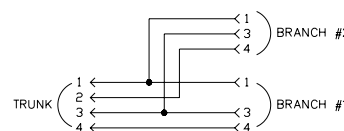

Diagram B



M12 Eurofast® and M8 Picofast® 2-Branch Molded Splitters

Specifications

Junction Body:	Oil resistant yellow TPU	Cable:	See table
Connector:	Oil resistant TPU body material, Nylon or TPU contact carrier	Temperature:	-40 °C to +105 °C (-40 °F to +221 °F)
Contacts:	Gold plated brass	Protection:	NEMA 1, 3, 4, 6P and IEC IP67
Coupling Nuts:	Nickel plated brass. POM locking sleeve	Accessories:	KS 5/10 labels included

Cable Length: Branches - nominal 0.3 meters. Other lengths available by request - consult factory.

We reserve the right to make technical alterations without prior notice.

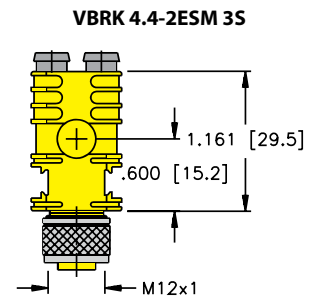
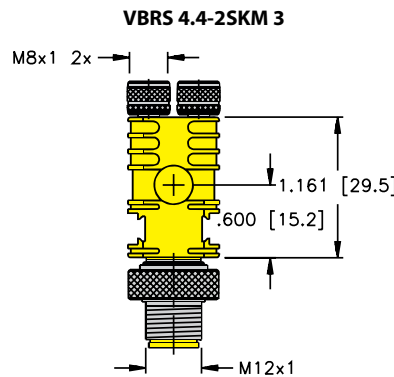
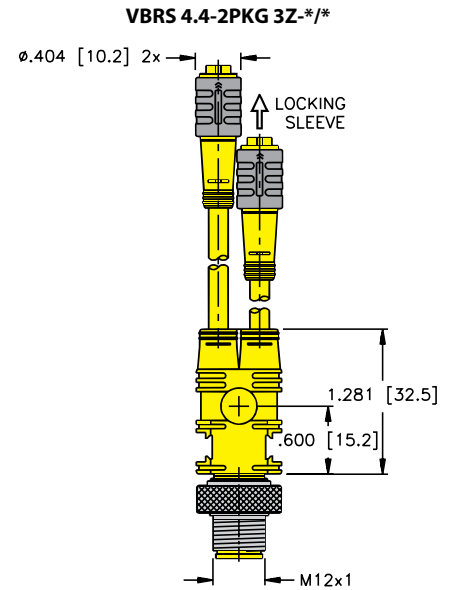
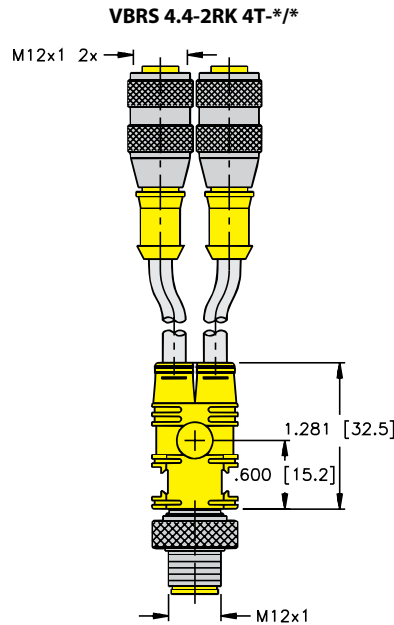
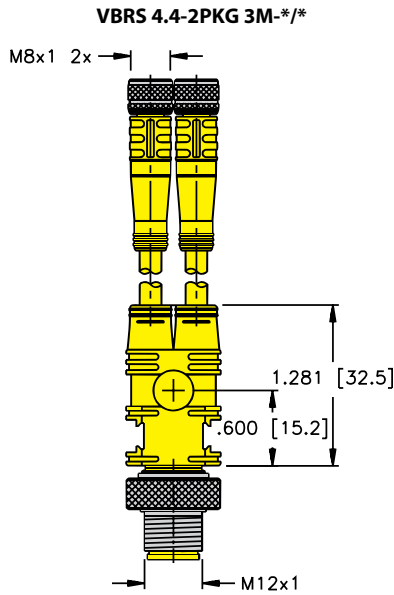

Pinout

3-Pin Picofast	4-Pin Eurofast	3-Pin Picofast	4-Pin Eurofast
Female		Male	

Splitters

M12 Eurofast® 2-Branch Splitters with Valve Plugs

- Combine two Valve Plugs into one Eurofast
- For use with Eurofast J-boxes with 2 Signals Port
- Available with all Valve Plug styles (A, B, I and C)



Part Number	Features	Wiring Diagram
VB2-RS 4.5T-*/2VAS 22-A528-*/*	220 V, 4.0 A, RS 4.5T = Grey PVC, 5.1 mm OD, 4x22 AWG, Valve plug = Grey PVC, 5.1 mm OD 3x20 AWG, combine two valve plugs into one cable. For use with 2 signal / port junction boxes. "A" style (18 mm) valve plugs.	Diagram A
VB2-RS 4.5T-*/2VBS 2-A528-*/*	220 V, 4.0 A, RS 4.5T = Grey PVC, 5.1 mm OD, 4x22 AWG, Valve plug = Grey PVC, 5.1 mm OD 3x20 AWG, combine two valve plugs into one cable. For use with 2 signal / port junction boxes. "B" style (10 mm) valve plugs.	
VB2-RS 4.5T-*/2VIS 2-A528-*/*	220 V, 4.0 A, RS 4.5T = Grey PVC, 5.1 mm OD, 4x22 AWG, Valve plug = Grey PVC, 5.1 mm OD 3x20 AWG, combine two valve plugs into one cable. For use with 2 signal / port junction boxes. "I" style (11 mm) valve plugs.	
VB2-RS 4.5T-*/2TC8S 2-A528-*/*	220 V, 4.0 A, RS 4.5T = Grey PVC, 5.1 mm OD, 4x22 AWG, Valve plug = Grey PVC, 5.1 mm OD 3x20 AWG, combine two valve plugs into one cable. For use with 2 signal / port junction boxes. "C" style (8 mm) valve plugs.	
VB2-RS 4.5T-*/2TC9S 2-A528-*/*	220 V, 4.0 A, RS 4.5T = Grey PVC, 5.1 mm OD, 4x22 AWG, Valve plug = Grey PVC, 5.1 mm OD 3x20 AWG, combine two valve plugs into one cable. For use with 2 signal / port junction boxes. "C" style (9.4 mm) valve plugs.	

* Length in meters.

We reserve the right to make technical alterations without prior notice.

Diagram A

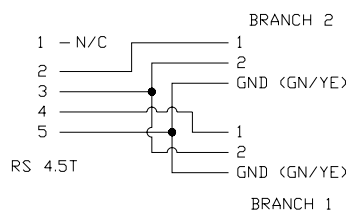

M12 Eurofast® 2-Branch Splitters with Valve Plugs

Specifications

Junction Body:	Oil resistant yellow TPU	Coupling Nuts:	Nickel plated brass
Connector:	Oil resistant TPU body material, Nylon or TPU contact carrier	Cable:	See table
Contacts:	Gold plated brass (Eurofast). Silver plated copper alloy (VALVE PLUG)	Temperature:	-40 °C to +105 °C (-40 °F to +221 °F)
		Protection:	IEC IP67

- Cable Length:** Trunk - nominal 1 meter. Branches - nominal 0.3 meters. Other lengths available by request - consult factory.
- Cable Options:** Other jackets available by request - consult factory.
- Valve Options:** Available w/LED or LED+MOV, consult factory.
- Eurofast Options:** Stainless steel coupling nut add "V" to part number (RS .. to RSV ..). Nylon coupling nut add "K" to part number (RS .. to RSK ..). Right angle connectors, change part number (RS .. to WS..).

We reserve the right to make technical alterations without prior notice.

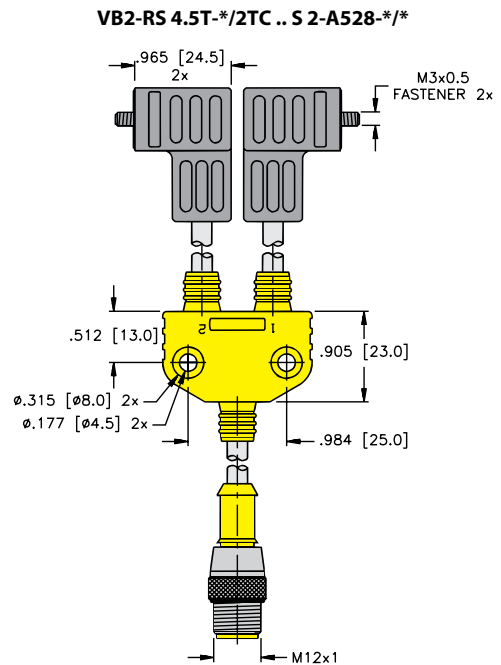
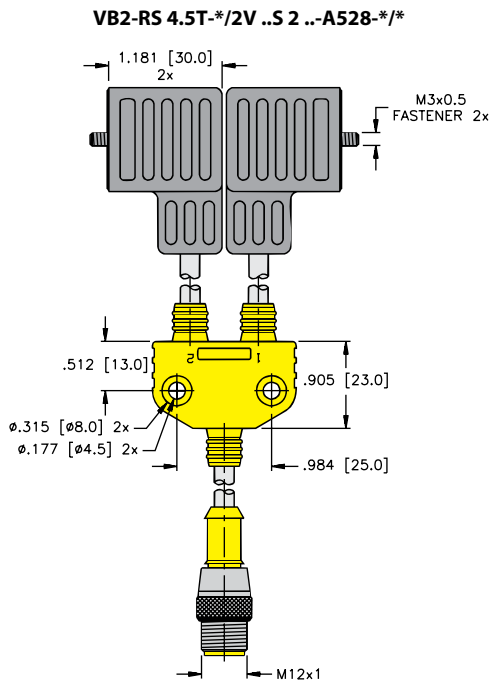

Pinouts

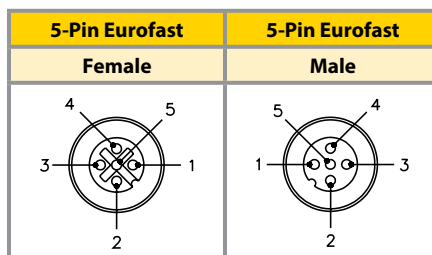

Splitters

M12 Eurofast® 4-Branch Splitters, Standard Wiring

- Combine four Sensors into one Cable
- Tough TPU Construction
- For 3-wire DC Sensors or Switches



Housing	Part Number	Features	Wiring Diagram
	<p>V6RSC-*/PKG3M-*/*/*/*</p>	<p>60 VAC/75 VDC, 2.0 A, RSC 6T = Grey PVC, 5.7 mm OD, 6x24 AWG, PKG = Yellow PVC, 4.4 mm OD, 3x24 AWG, combine four sensors into one cable</p>	<p>Standard</p>

* Length in meters.

We reserve the right to make technical alterations without prior notice.

Wiring Diagram

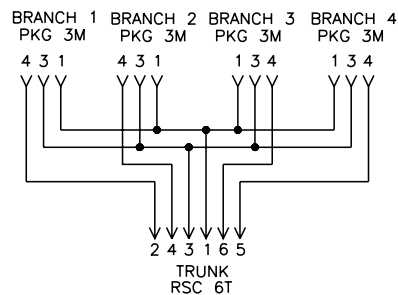

M12 Eurofast® 4-Branch Splitters, Standard Wiring

Specifications

Junction Body:	Oil resistant yellow TPU	Coupling Nuts:	Nickel plated brass
Connector:	Oil resistant TPU body material, Nylon or TPU contact carrier	Cable:	See table
Contacts:	Gold plated brass	Temperature:	-40 °C to +105 °C (-40 °F to +221 °F)
		Protection:	IEC IP67

- Cable Length:** Trunk - nominal 1 meter. Branches - nominal 0.3 meters. Other lengths available by request - consult factory.
- Cable Options:** Standard cable jacket - grey PVC. TPU and other jackets available by request - consult factory.
- Connector Options:** (for legs with cable)
Stainless steel coupling nut add "V" to part number (PKG to PKGV).
- Notes:** Mounting hole accepts #8 screw.

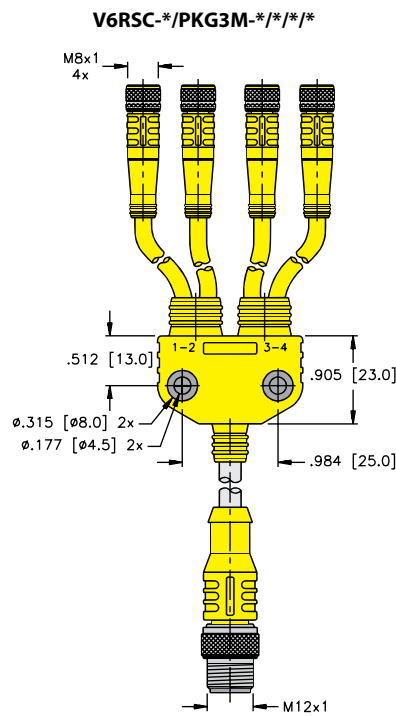

We reserve the right to make technical alterations without prior notice.

Splitters

Pinouts

3-Pin	6-Pin
Female	Male

Splitters

M12 Eurofast® 4-Branch Splitters, Standard Wiring

- For use on Photoelectric Controls, Power Distribution and other Parallel-wired applications
- Tough TPU Construction



Housing	Part Number	Features	Wiring Diagram
	<p>V3RS-*/RK4-*/*/*/S651</p>	<p>60 VAC /75 VDC, 2.0 A, Yellow PVC, 4.4 mm OD, 3x24 AWG, parallel wired, 3 conductor</p>	<p>Parallel</p>

* Length in meters.

We reserve the right to make technical alterations without prior notice.

Wiring Diagram

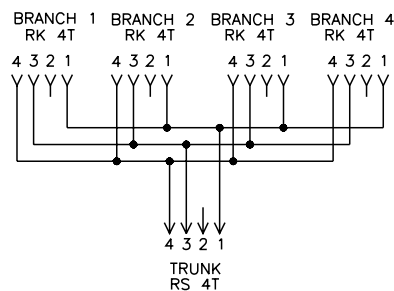

M12 Eurofast® 4-Branch Splitters, Standard Wiring

Specifications

Junction Body:	Oil resistant yellow TPU	Coupling Nuts:	Nickel plated brass
Connector:	Oil resistant TPU body material, Nylon or TPU contact carrier	Cable:	See table
Contacts:	Gold plated brass	Temperature:	-40 °C to +105 °C (-40 °F to +221 °F)
		Protection:	IEC IP67

Cable Length: Trunk - nominal 1 meter. Branches - nominal 0.3 meters. Other lengths available by request - consult factory.

Cable Options: Standard cable jacket - grey PVC. TPU and other jackets available by request - consult factory.

Connector Options: (for legs with cable)

Stainless steel coupling nut add "V" to part number (RS to RSV, RK to RKV).

Nylon coupling nut add "K" to part number (RS to RSK, RK to RKK).

Right angle connectors, change part number (RS to WS, RK to WK).

Notes: Mounting holes accept #8 screw.

V3RS-*/RK4-*/**/*/*S651

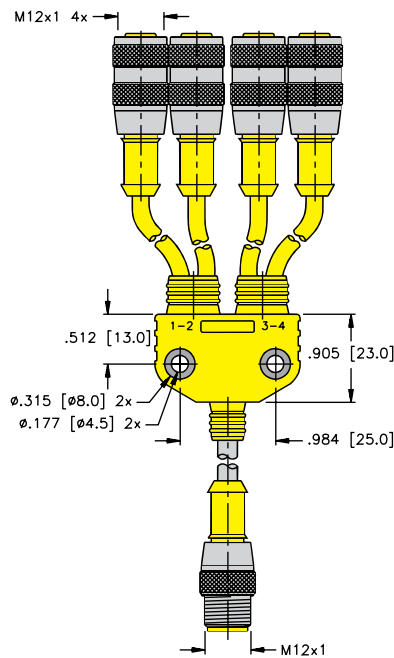

We reserve the right to make technical alterations without prior notice.

Pinouts

4-Pin	
Female	Male

Splitters

M12 Eurofast® 4-Branch Splitters, Parallel Wiring

- For use on Photoelectric Controls, Power Distribution and other Parallel-wired applications
- Tough TPU Construction

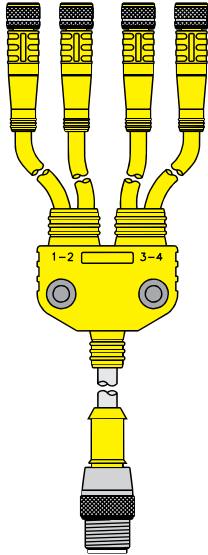

Housing	Part Number	Features	Wiring Diagram
	<p>V4RS-*/PKG4M-*/*/*/S651</p>	<p>125 VAC / VDC, 2.0 A, RS 4.4T = Grey PVC, 5.1 mm OD, 4x22 AWG, PKG 4M = Yellow PVC, 4.4 mm OD, 4x26 AWG, parallel wired, 4 conductor</p>	<p>Parallel</p>

* Length in meters.

We reserve the right to make technical alterations without prior notice.

Wiring Diagram

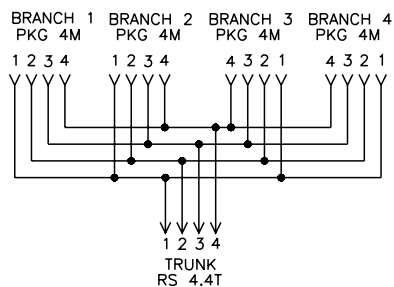

M12 Eurofast® 4-Branch Splitters, Parallel Wiring

Specifications

Junction Body:	Oil resistant yellow TPU	Coupling Nuts:	Nickel plated brass
Connector:	Oil resistant TPU body material, Nylon or TPU contact carrier	Cable:	See table
Contacts:	Gold plated brass	Temperature:	-40 °C to +105 °C (-40 °F to +221 °F)
		Protection:	IEC IP67

- Cable Length:** Trunk - nominal 1 meter. Branches - nominal 0.3 meters. Other lengths available by request - consult factory.
- Cable Options:** Standard cable jacket - grey PVC. TPU and other jackets available by request - consult factory.
- Connector Options:** (for legs with cable)
 Stainless steel coupling nut add "V" to part number (PSG to PSGV, PKG to PKGV).
 Right angle connectors, change part number (RS to WS, RK to WK).
- Notes:** Mounting holes accept #8 screw.

V4RS-*/PKG4M-*/**/*/*S651

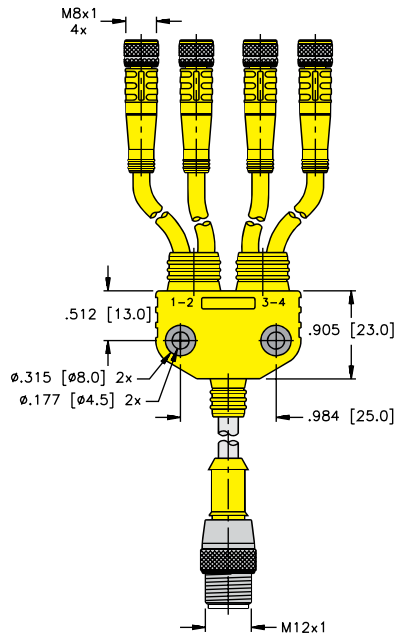

We reserve the right to make technical alterations without prior notice.

Pinouts

4-Pin	
Female	Male

Splitters

M12 Eurofast® 4-Branch Splitters, Parallel Wiring

- For use on Photoelectric Controls, Power Distribution and other Parallel-wired applications
- Tough TPU Construction



Housing	Part Number	Features	Wiring Diagram
	<p>V4FSM/RK4.4-*/**/*/*/*S651</p>	<p>250 V, 2.0 A, RK 4.4T = Yellow PVC, 4.4 mm OD, 4x26 AWG, parallel wired, 4 conductor</p>	<p>Parallel</p>

* Length in meters.

We reserve the right to make technical alterations without prior notice.

Wiring Diagram

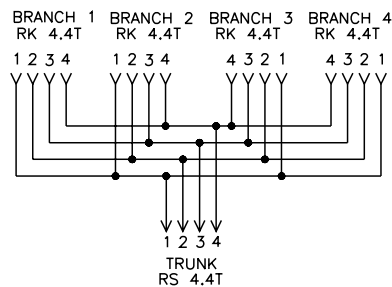

M12 Eurofast® 4-Branch Splitters, Parallel Wiring

Specifications

Junction Body:	Oil resistant yellow TPU	Coupling Nuts:	Nickel plated brass
Connector:	Oil resistant TPU body material, Nylon or TPU contact carrier	Cable:	See table
Contacts:	Gold plated brass	Temperature:	-40 °C to +105 °C (-40 °F to +221 °F)
		Protection:	IEC IP67

Cable Length: Trunk - nominal 1 meter. Branches - nominal 0.3 meters. Other lengths available by request - consult factory.

Cable Options: Standard cable jacket - grey PVC. TPU and other jackets available by request - consult factory.

Connector Options: (for legs with cable)

Stainless steel coupling nut add "V" to part number (RS to RSV, RK to RKV).

Nylon coupling nut add "K" to part number (RS to RSK, RK to RKK).

Right angle connectors, change part number (RS to WS, RK to WK).

Notes: Mounting holes accept #8 screw.

V4FSM/RK4.4-*/*/*/S651

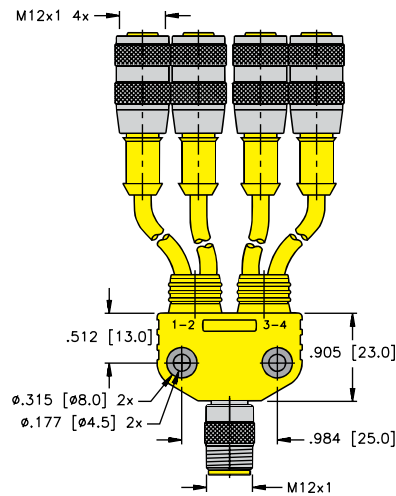

We reserve the right to make technical alterations without prior notice.

Pinouts

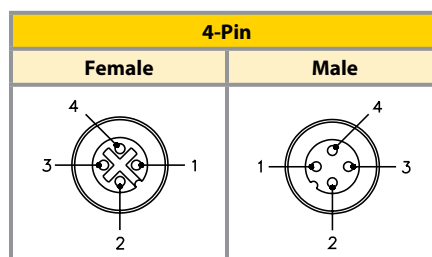

Splitters

M12 Eurofast® 4-Branch Splitters, Parallel Wiring

- For use on Photoelectric Controls, Power Distribution and other Parallel-wired applications
- Tough TPU Construction



Housing	Part Number	Features	Wiring Diagram
	V4RS-*/RK4.4-*/**/**/S651	250 V, 2.0 A, RS 4.4T = Grey PVC, 5.1 mm OD, 4x22 AWG, RK 4.4T = Yellow PVC, 4.4 mm OD, 4x26 AWG, parallel wired, 4 conductor	Parallel

* Length in meters.

We reserve the right to make technical alterations without prior notice.

Wiring Diagram

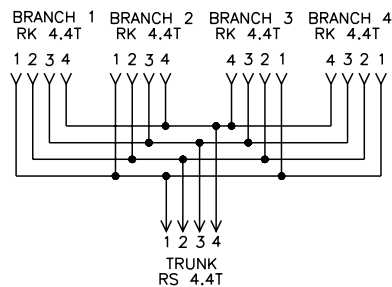

M12 Eurofast® 4-Branch Splitters, Parallel Wiring

Specifications

Junction Body:	Oil resistant yellow TPU	Coupling Nuts:	Nickel plated brass
Connector:	Oil resistant TPU body material, Nylon or TPU contact carrier	Cable:	See table
Contacts:	Gold plated brass	Temperature:	-40 °C to +105 °C (-40 °F to +221 °F)
		Protection:	IEC IP67

- Cable Length:** Trunk - nominal 1 meter. Branches - nominal 0.3 meters. Other lengths available by request - consult factory.
- Cable Options:** Standard cable jacket - grey PVC. TPU and other jackets available by request - consult factory.
- Connector Options:** (for legs with cable)
 Stainless steel coupling nut add "V" to part number (RS to RSV, RK to RKV).
 Nylon coupling nut add "K" to part number (RS to RSK, RK to RKK).
 Right angle connectors, change part number (RS to WS, RK to WK).
- Notes:** Mounting holes accept #8 screw.

We reserve the right to make technical alterations without prior notice.

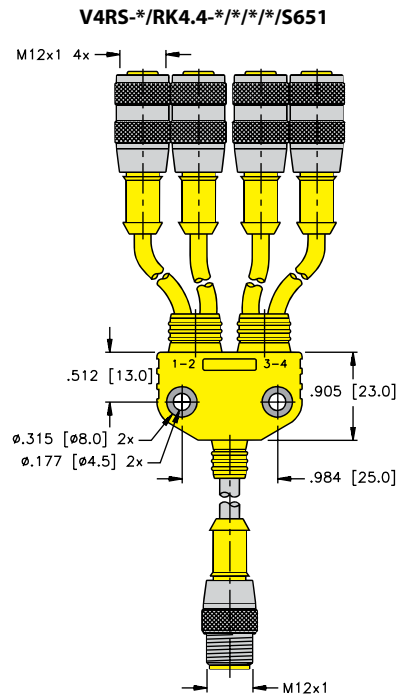

Pinouts

4-Pin	
Female	Male

Splitters

M12 Eurofast® 4-Branch Splitters, Series Wiring

- Combine four Sensors into one Cable
- Series Wired
- Tough TPU Construction
- For 3-wire DC Sensors or Switches



Housing	Part Number	Features	Wiring Diagram
	<p>V3RS-*/RK 4-*/**/**/S719</p>	<p>60 VAC/75 VDC, 2.0 A, Grey PVC, 4.4 mm OD, 3x24 AWG, series wired for and function PNP signals</p>	<p>Series</p>

* Length in meters.

We reserve the right to make technical alterations without prior notice.

Wiring Diagram

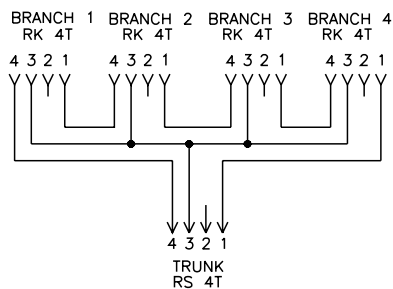

M12 Eurofast® 4-Branch Splitters, Series Wiring

Specifications

Junction Body:	Oil resistant yellow TPU	Coupling Nuts:	Nickel plated brass
Connector:	Oil resistant TPU body material, Nylon or TPU contact carrier	Cable:	See table
Contacts:	Gold plated brass	Temperature:	-40 °C to +105 °C (-40 °F to +221 °F)
		Protection:	IEC IP67

Cable Length: Trunk - nominal 1 meter. Branches - nominal 0.3 meters. Other lengths available by request - consult factory.

Cable Options: Standard cable jacket - grey PVC. TPU and other jackets available by request - consult factory.

Connector Options: (for legs with cable)

Stainless steel coupling nut add "V" to part number (RS to RSV, RK to RKV).

Nylon coupling nut add "K" to part number (RS to RSK, RK to RKK).

Right angle connectors, change part number (RS to WS, RK to WK).

Notes: Mounting holes accept #8 screw.

V3RS-*/RK 4-*/**/**/S719

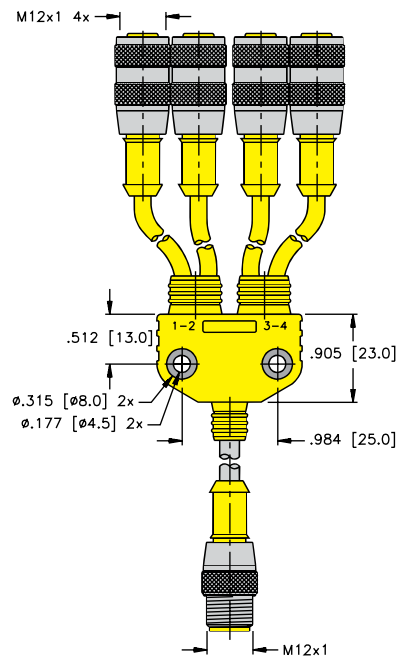

We reserve the right to make technical alterations without prior notice.

Pinouts

4-Pin	
Female	Male

Splitters

M8 Picofast® 2-Branch Compact Splitters, Standard and LED Wiring

- Combine two Sensors into one Cable
- For use on Cylinders and other Dual-Input applications
- Tough TPU Construction
- IEC IP67 Protection

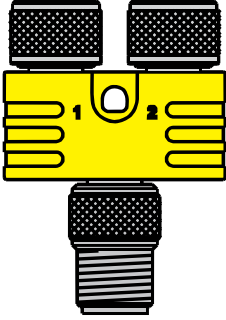

Housing	Part Number	Features	Wiring Diagram
	YP2-MFS 4/2MFK 3	125 V, 2 A, 2 Picofast branches, 3-wire & 1 Picofast trunk, 4-wire	Standard 3-wire
	YP2-PX2-MFS 4/2MFK 3	30 V, 2 A, 2 Picofast branches, 3-wire & 1 Picofast trunk, 4-wire, LEDs	LED 3-wire

We reserve the right to make technical alterations without prior notice.

Wiring Diagrams

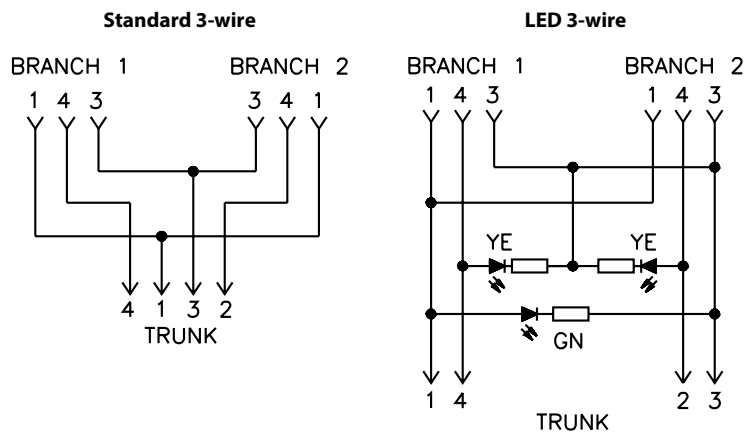

M8 Picofast® 2-Branch Compact Splitters, Standard and LED Wiring

Specifications

Junction Body:	Oil resistant yellow TPU	Coupling Nuts:	Nickel plated brass
Connector:	Oil resistant TPU body material, Nylon or TPU contact carrier	Temperature:	-30 °C to +80 °C (-22 °F to +176 °F)
Contacts:	Gold plated brass	Protection:	NEMA 1, 3, 4, 6P and IEC IP67

Notes: Mounting hole accepts #4 screw.

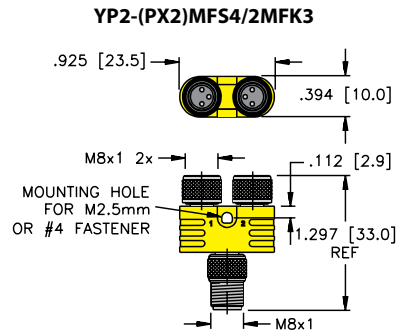

We reserve the right to make technical alterations without prior notice.

Pinouts

3-pin Picofast	4-pin Picofast
Female	Male

Splitters

M8 Picofast® 2-Branch Compact Splitters, Standard and Parallel Wiring

- Combine two Sensors into one Cable
- For use on Cylinders and other Dual-Input applications
- Tough TPU Construction
- IEC IP67 Protection



Housing	Part Number	Features	Wiring Diagram
	YP2-MFS3/2PKG3M-*/*/S651	125 V, 4 A, PKG 3M = Yellow PVC, 4.4 mm OD, 3x24 AWG, 2 Picofast branches, 3-wire & 1 Picofast trunk, 3-wire	Parallel 3-wire
	YP2-MFS4/2PKG3M-*/*	125 V, 2 A, PKG 3M = Yellow PVC, 4.4 mm OD, 3x24 AWG, 2 Picofast branches, 3-wire & 1 Picofast trunk, 4-wire	Standard 3 to 4-wire
	YP2-MFS4/2PKG4M-*/*/S651	125 V, 2 A, PKG 4M = Yellow PVC, 4.4 mm OD, 4x26 AWG, 2 Picofast branches, 4-wire & 1 Picofast trunk, 4-wire	Parallel 4-wire

* Length in meters.

We reserve the right to make technical alterations without prior notice.

Wiring Diagrams

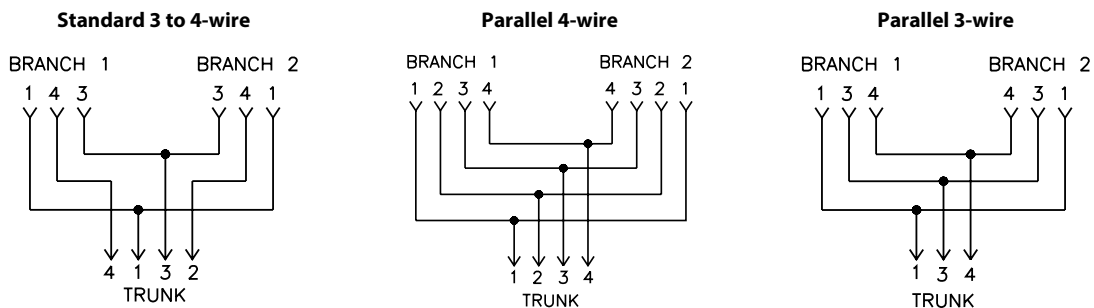

M8 Picofast® 2-Branch Compact Splitters, Standard and Parallel Wiring

Specifications

Junction Body:	Oil resistant yellow TPU	Coupling Nuts:	Nickel plated brass
Connector:	Oil resistant TPU body material, Nylon or TPU contact carrier	Cable:	See table
Contacts:	Gold plated brass	Temperature:	-40 °C to +105 °C (-40 °F to +221 °F)
		Protection:	NEMA 1, 3, 4, 6P and IEC IP67

- Cable Length:** Branches - nominal 0.3 meters. Other lengths available by request - consult factory.
- Cable Options:** Standard cable jacket - grey/yellow PVC. TPU and other jackets available by request - consult factory.
- Connector Options:** (for legs with cable)
Stainless steel coupling nut add "V" to part number (PKG to PKGV, PSG to PSGV, RK to RKV).
- Notes:** Mounting hole accepts #4 screw.

YP2-MFS3(4)/2PKG3(4)M-*/*/(S651)

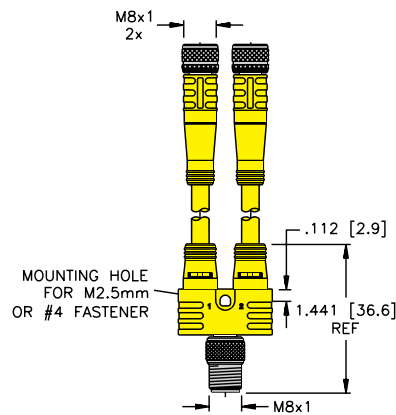

We reserve the right to make technical alterations without prior notice.

Pinouts

3-Pin Picofast	4-pin Picofast	3-Pin Picofast	4-pin Picofast
Female		Male	

Splitters

M8 Picofast® 2-Branch Compact Splitters, Standard and Parallel Wiring

- Combine two Sensors into one Cable
- For use on Cylinders and other Dual-Input applications
- Tough TPU Construction
- IEC IP67 Protection



Housing	Part Number	Features	Wiring Diagram
	YP2-PSG3M-*/2PKG3M-*/S651	125 V, 4 A, PSG 3M & PKG3M = Yellow PVC, 4.4 mm OD, 3x24 AWG, 2 Picofast branches, 3-wire & 1 Picofast trunk, 3-wire	Parallel 3-wire
	YP2-PSG4M-*/2PKG3M-*/S651	125 V, 2 A, PSG 4M = Yellow PVC, 4.4 mm OD, 4x26 AWG, PKG3M = Yellow PVC, 4.4 mm OD, 3x24 AWG, 2 Picofast branches, 3-wire & 1 Picofast trunk, 4-wire	Standard 3 to 4-wire
	YP2-PSG4M-*/2PKG4M-*/S651	125 V, 2 A, PSG 4M & PKG4M = Yellow PVC, 4.4 mm OD, 4x26 AWG, 2 Picofast branches, 4-wire & 1 Picofast trunk, 4-wire	Parallel 4-wire
	YP2-PSG6M-*/2PKG6M-*/S651	125 V, 2 A, PSG 6M & PKG 6M = Yellow PVC, 4.5 mm OD, 6x26 AWG, 2 Picofast branches, 6-wire & 1 Picofast trunk, 6-wire	Parallel 6-wire

We reserve the right to make technical alterations without prior notice.

* Length in meters.

Wiring Diagrams

Standard, 3 to 4-wire

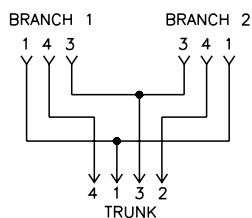

Parallel, 3-wire

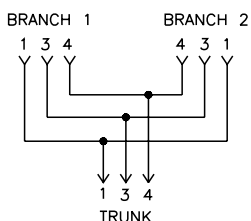

Parallel, 4-wire

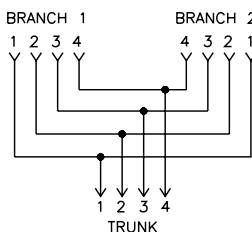

Parallel, 6-wire

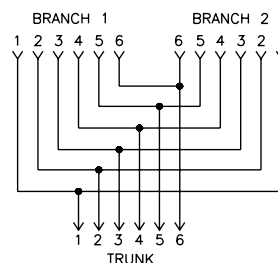

M8 Picofast® 2-Branch Compact Splitters, Standard and Parallel Wiring

Specifications

Junction Body:	Oil resistant yellow TPU	Coupling Nuts:	Nickel plated brass
Connector:	Oil resistant TPU body material, Nylon or TPU contact carrier	Cable:	See table
Contacts:	Gold plated brass	Temperature:	-40 °C to +105 °C (-40 °F to +221 °F)
		Protection:	NEMA 1, 3, 4, 6P and IEC IP67

Cable Length: Trunk - nominal 1 meter. Branches - nominal 0.3 meters. Other lengths available by request - consult factory.
Cable Options: Standard cable jacket - grey/yellow PVC. TPU and other jackets available by request - consult factory.
Connector Options: (for legs with cable) Stainless steel coupling nut add "V" to part number (PKG to PKGV, PSG to PSGV, RK to RKV).
Notes: Mounting hole accepts #4 screw.

YP2-PSG3(4,6)M-*/2PKG3(4,6)M-*/*(/S651)

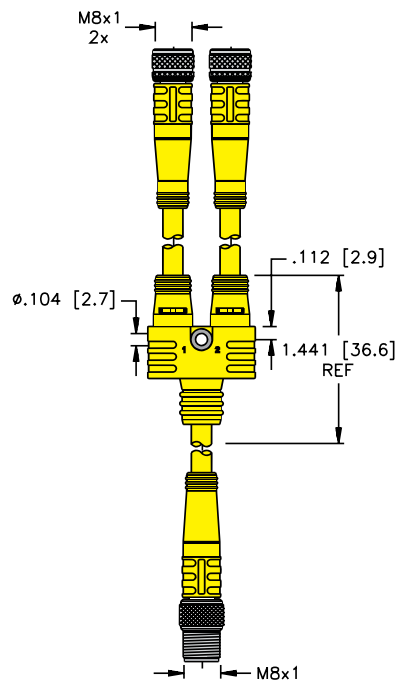

We reserve the right to make technical alterations without prior notice.

Pinouts

3-pin Picofast	4-pin Picofast	6-pin Picofast	3-pin Picofast	4-pin Picofast	6-pin Picofast
Female			Male		

Splitters

M8 Picofast® 2-Branch Compact Splitters, Standard Wiring

- Combine two Sensors into one Cable
- For use on Cylinders and other Dual-Input applications
- Tough TPU Construction
- IEC IP67 Protection



Housing	Part Number	Features	Wiring Diagram
	<p>YP2-PSG4M-*/2RK4T-*/*</p>	<p>125 V, 2 A, PSG 4M = Yellow PVC, 4.4 mm OD, 4x26 AWG, RK 4T = Grey PVC, 5.1 mm OD, 3x20 AWG, 2 Eurofast® branches, 4-wire & 1 Picofast trunk, 4-wire</p>	<p>Standard</p>

We reserve the right to make technical alterations without prior notice.

* Length in meters.

Wiring Diagram

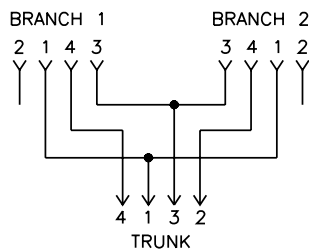

M8 Picofast® 2-Branch Compact Splitters, Standard Wiring

Specifications

Junction Body:	Oil resistant yellow TPU	Coupling Nuts:	Nickel plated brass
Connector:	Oil resistant TPU body material, Nylon or TPU contact carrier	Cable:	See table
Contacts:	Gold plated brass	Temperature:	-40 °C to +105 °C (-40 °F to +221 °F)
		Protection:	NEMA 1, 3, 4, 6P and IEC IP67

Cable Length: Trunk - nominal 1 meter. Branches - nominal 0.3 meters. Other lengths available by request - consult factory.
Cable Options: Standard cable jacket - grey/yellow PVC. TPU and other jackets available by request - consult factory.
Connector Options: (for legs with cable) Stainless steel coupling nut add "V" to part number (PKG to PKGV, PSG to PSGV, RK to RKV).
Notes: Mounting hole accepts #4 screw.

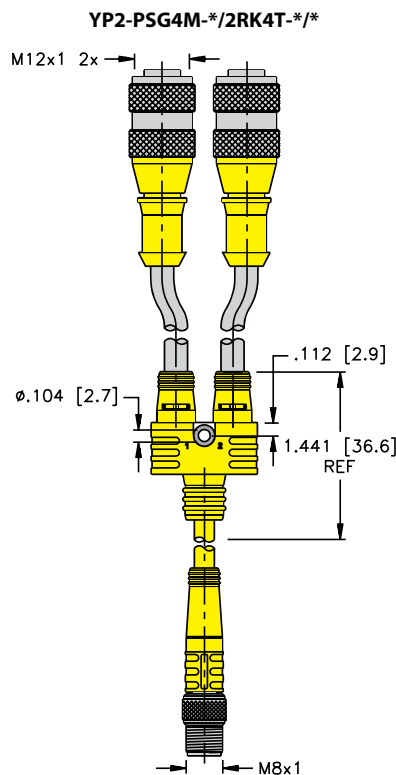

We reserve the right to make technical alterations without prior notice.

Splitters

Pinouts

4-pin Eurofast®	4-pin Picofast
Female	Male

Splitters

M8 Picofast® 4-Branch Splitters, Parallel Wiring

- For use on Photoelectric Controls, Power Distribution and other Parallel-wired applications
- Tough TPU Construction



Housing	Part Number	Features	Wiring Diagram
	<p>V3PSG-*/PKG3Z-*/*/*/S651</p>	<p>125 V, 2.0 A, Yellow PVC, 4.4 mm OD, 3x24 AWG, parallel wired, 3 conductor</p>	<p>Parallel</p>

* Length in meters.

We reserve the right to make technical alterations without prior notice.

Wiring Diagram

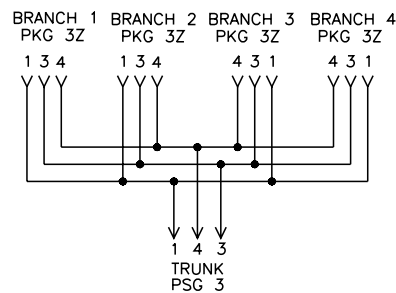

M8 Picofast® 4-Branch Splitters, Parallel Wiring

Specifications

Junction Body:	Oil resistant yellow TPU	Coupling Nuts:	Nickel plated brass
Connector:	Oil resistant TPU body material, Nylon or TPU contact carrier	Cable:	See table
Contacts:	Gold plated brass	Temperature:	-40 °C to +105 °C (-40 °F to +221 °F)
		Protection:	IEC IP67

Cable Length: Trunk - nominal 1 meter. Branches - nominal 0.3 meters. Other lengths available by request - consult factory.
Cable Options: Standard cable jacket - grey PVC. TPU and other jackets available by request - consult factory.
Notes: Mounting holes accept #8 screw.

V3PSG-*/PKG3Z-*/**/*/*/S651

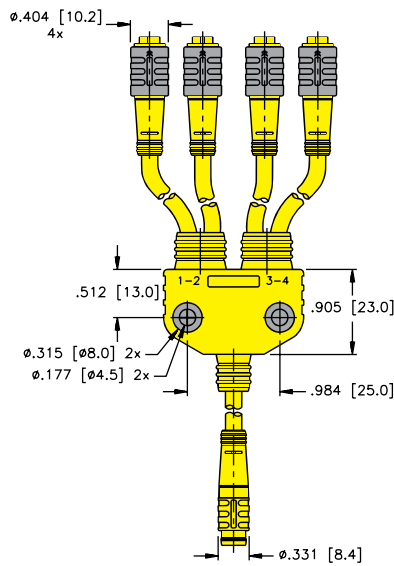

We reserve the right to make technical alterations without prior notice.

Splitters

Pinouts

3-Pin	
Female	Male
<p>Diagram showing the pinout for the Female connector. It features three pins arranged in a circle. Pin 1 is at the top-left, pin 3 is at the top-right, and pin 4 is at the bottom.</p>	<p>Diagram showing the pinout for the Male connector. It features three pins arranged in a circle. Pin 3 is at the top-left, pin 1 is at the top-right, and pin 4 is at the bottom.</p>

Splitters

M8 Picofast® 4-Branch Splitters, Parallel Wiring

- For use on Photoelectric Controls, Power Distribution and other Parallel-wired applications
- Tough TPU Construction



Housing	Part Number	Features	Wiring Diagram
	<p>V4PSGM-*/PKG4M-*/*/*/S651</p>	<p>125 V, 2.0 A, yellow PVC, 4.4 mm OD, 4x26 AWG, parallel wired, 4 conductor</p>	<p>Parallel</p>

* Length in meters.

We reserve the right to make technical alterations without prior notice.

Wiring Diagram

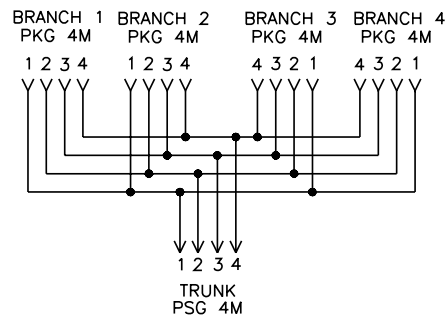

M8 Picofast® 4-Branch Splitters, Parallel Wiring

Specifications

Junction Body:	Oil resistant yellow TPU	Coupling Nuts:	Nickel plated brass
Connector:	Oil resistant TPU body material, Nylon or TPU contact carrier	Cable:	See table
Contacts:	Gold plated brass	Temperature:	-40 °C to +105 °C (-40 °F to +221 °F)
		Protection:	IEC IP67

- Cable Length:** Trunk - nominal 1 meter. Branches - nominal 0.3 meters. Other lengths available by request - consult factory.
- Cable Options:** Standard cable jacket - grey PVC. TPU and other jackets available by request - consult factory.
- Connector Options:** (for legs with cable)
Stainless steel coupling nut add "V" to part number (PSG to PSGV, PKG to PKGV).
- Notes:** Mounting holes accept #8 screw.

V4PSGM-*/PKG4M-*/**/**/S651

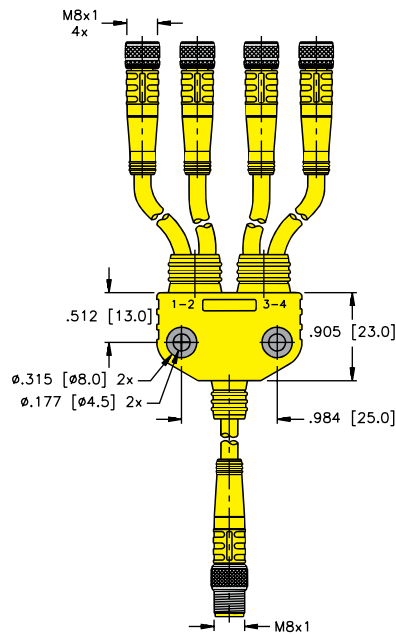

We reserve the right to make technical alterations without prior notice.

Pinouts

4-Pin	
Female	Male

Splitters

M8 Picofast® to M12 Eurofast® Adapters

- Enables Picofast and Eurofast Connectors to be interchanged
- Compact size saves space
- Eurofast Connection has Anti-vibration Coupling Nut



Part Number	Features	Wiring Diagram
FKMR 4-ESM 3S	60 VAC/75 VDC, 4.0 A, female Eurofast, male snap-lock Picofast connector, 3-pin	
FKMR 4.4-ESM 4S	30 VAC/36 VDC, 4.0 A, female Eurofast, male snap-lock Picofast connector, 4-pin	
FSMR 4-SKM 3	60 VAC/75 VDC, 4.0 A, male Eurofast, female threaded Picofast connector, 3-pin	
FSMR 4.4-SKM 4	30 VAC/36 VDC, 4.0 A, male Eurofast, female threaded Picofast connector, 4-pin	

To add mounting hole, add /S857 to the end of the part number.

We reserve the right to make technical alterations without prior notice.

M8 Picofast® to M12 Eurofast® Adapters

Specifications

Junction Body: Oil resistant blue-gray TPU
Connector: Nylon or TPU contact holder
Contacts: Gold plated brass

Coupling Nuts: Nickel plated brass
Temperature: -30 °C to +80 °C (-22 °F to +176 °F)
Protection: NEMA 1, 3, 4, 6P and IEC IP67

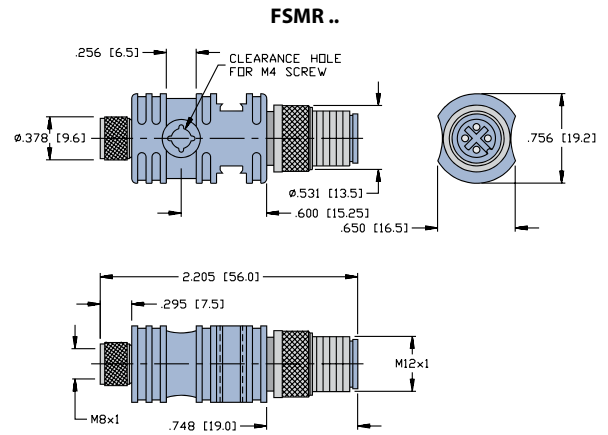
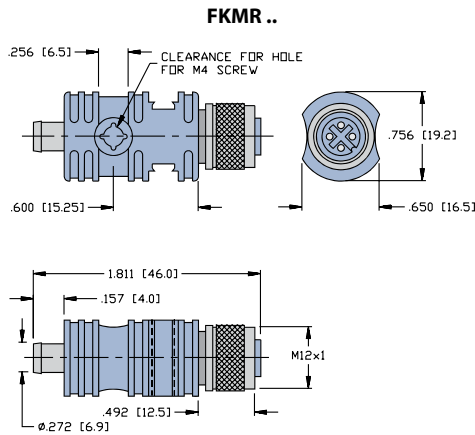

We reserve the right to make technical alterations without prior notice.

Pinouts

3-pin Picofast	4-pin Picofast	4-Pin Eurofast	3-pin Picofast	4-pin Picofast	4-Pin Eurofast
Female			Male		

Splitters

Multibox® 2 - Branch Molded Splitters

- Consolidate two Sensors/Actuators into one
- M8 Picofast® or M12 Eurofast® Connector Branches
- Tough TPU Construction
- IEC IP67 Protection



Housing	Part Number	Features	Wiring Diagram
	YB2-FSM 4.5-2FKM 4.5 (Fits 8MB12 J-boxes)	2 Eurofast branches, black TPU, 80 °C, 30 VAC/36 VDC, 4 A, combine two sensors/actuators with Eurofast connector branches into one	
	YB2-FSM 4.5-2FKM 4.5/S1063 (Fits VB J-boxes)	2 Eurofast branches, grey TPU, 80 °C, 30 VAC/36 VDC, 4 A, combine two sensors/actuators with Eurofast connector branches into one	
	YB2-FSM 4.5-2FKM 4.5-P7X3	2 Eurofast branches, translucent black TPU, 80 °C, 30 VDC, 4 A, 3 LEDs, PNP, combine two sensors/actuators with Eurofast connector branches into one	
	YB2-FSM 4.4/2PKG 3M	2 Picofast branches, black TPU, 80 °C, 30 VAC/36 VDC, 2 A, combine two sensors/actuators with Picofast connector branches into one	
	YB2-FSM 4.4/2PKG 3M-P7X3	2 Picofast branches, translucent black TPU, 80 °C, 30 VDC, 2 A, 3 LEDs, PNP, combine two sensors/actuators with Picofast connector branches into one	
	YB22-FSM 4.5/2FKM 4.5/S771	2 Eurofast branches, black TPU, 80 °C, 30 VAC/36 VDC, 4 A, combine two sensors/actuators with Eurofast connector branches into one	
	YB22-PX3-FSM 4.5/2FKM 4.5	2 Eurofast branches, transparent TPU, 80 °C, 36 VDC, 4 A, 3 LEDs, PNP, combine two sensors/actuators with Eurofast connector branches into one	

We reserve the right to make technical alterations without prior notice.

Standard coupling nut material is nickel plated brass.

Pinouts

5-Pin Eurofast	3-Pin Picofast	5-Pin Eurofast	4-Pin Eurofast
Female		Male	

Turck Standards	W2
NRTL and RoHS	W3
Shielded Cordsets	W4
IP Protection Class, IEC, NEMA and NEMA 250	W5
Conversion Charts	W9
NEC	W10
Cable Applications	W11
Cable Selection Guide	W13
Glossary	W16

Connectivity Products

Turck Standards

One or more of the following standards may apply to products or components of products in this catalog. This section is intended to provide a reference to the applicable standards only. Original or facsimiles of the original standards documents should be used for interpretation. It is the responsibility of the user to determine the suitability of use of the products represented in this catalog.

ANSI/B93.55M

Generally defines the geometry and connection scheme of “mini” type connectors used in fluid power (valve) applications. It defines the numerical marking of the pins and the conductor size and colors for 3 and 5 pin versions. This specification was the basis for the so-called “automotive” standard conductor colors that are widely used on sensors.

CENELEC EN 50 044

Identifies connections for inductive proximity switches. The specification defines conductor colors for proximity switches with 2, 3, or 4 conductors. It also defines numerical marking of the terminals, whether quick disconnect, or not. Turck sensors and recommended cordsets that apply within the scope of the standard comply with CENELEC EN 50 044. The conventions defined in this standard have been widely adopted in industry to include photoelectric controls and other related sensing devices.

CSA

The Canadian Standards Association is a not-for-profit membership-based association serving business, industry, government and consumers in Canada and the global marketplace.

Is the CSA mark valid across America?

Yes. CSA International is accredited by the Occupational Health and Safety Administration (OSHA) as a Nationally Recognized Testing Laboratory (NRTL). The CSA tests to the same American industry standards as other accredited laboratories, regardless of who authored or published the standard. CSA marks are recognized and accepted throughout America by federal, state and local authorities.

DIN 43650

Defines the geometry and other characteristics of the “square” connectors most frequently used on hydraulic and pneumatic solenoid valves and other devices in the fluid power industry.

MSHA

The Mine Safety and Health Administration - a US Government agency that ensures and regulates safety for mines and mine workers. The MSHA approval is required for products used in underground mines, including electrical equipment, power cords, and instrumentation components.

The MSHA standards require special fire-resistant properties and characteristics that prevent the propagation of flames.

IEC 61076-2-101

Defines the geometry and other characteristics of the M12x1 family of threaded connectors used to connect control and measurement devices in industrial environments.

IEC 61076-2-104

Defines the geometry and other characteristics of the M8x1 family of threaded and snap connectors used to connect control and measurement devices in industrial environments.

NRTL

Nationally Recognized Test Laboratory - An independent laboratory authorized by the US Government to perform product safety evaluations. Test laboratories must meet government laboratory standards, and are audited annually by OSHA to maintain this credential. UL standards are adopted by the US government and OSHA as being "Safety Standards", and these accredited labs then use the UL standards to perform product evaluations.

The Canadian Standards Association (CSA) is authorized as a NRTL to perform product evaluations and tests to the UL Standards. The certification mark "CSA NRTL/C" is then applied to products that satisfy all construction and performance criteria for both US and Canada. This certification mark is generally accepted by local building, safety, and quality agencies as meeting safety, construction, and performance criteria in both the US and Canada.

RoHS (Restriction of Hazardous Substances in Electrical and Electronic Equipment)

In Europe, the RoHS directive is the legal basis for the ban of certain materials (lead and other specific heavy metals) in electric and electronic products. This directive was adopted and implemented in Europe as of July 1st, 2006.



This directive is geared towards high volume consumer goods. Turck is not required to adopt the directive, but is affected by the legal requirements which prescribe that only lead-free products and components to be sold in Europe. Turck, however, is engaged in testing lead-free soldering and substitute substances/components in support of our commitment to the environment. The main issue we had to overcome to become RoHS compliant was our solder material that contained lead. We have tested and verified a RoHS approved solder material which was implemented as of May 1st, 2006 and a RoHS logo will be added to bag labels for those parts. Please be aware that there are certain products like PCBs and ITC/PLTC cable that will continue to contain restricted substances.

Shielded Cordsets

Whenever wire is used to transmit electrical data, it is possible for the wire to absorb external noise, possibly changing the characteristics of the electrical signal, or to give off noise that could cause changes in other electrical components that are near. Shielding is the act of placing conductive material between the potential noise emitters and receivers.

Electrical noise is usually classified as electro-magnetic interference (EMI) or radio frequency interference (RFI).

Turck offers a number of shielding options:

1. Foil shield with drain, drain not connected

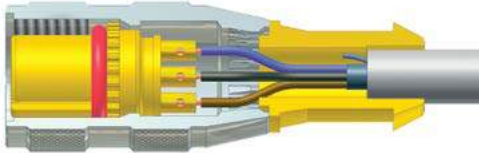

3. Foil and braid shield with shield tied to coupling nut

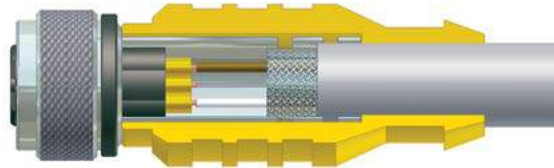

2. Foil shield with drain, drain connected to a pin

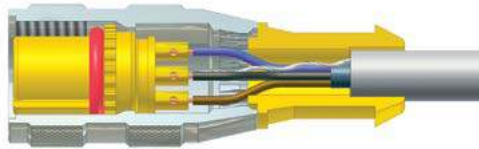

4. Aluminum armored cable with armor tied to coupling nut



For a shield to be effective, it must be tied to a ground at some point. It is usually preferred to not tie the shield to ground at more than one point to avoid ground loops. A shield not tied to a ground will reflect some noise and is better than no shield at all, but will be much more effective if tied to a ground.

High frequency noise, RFI, is handled well with a foil shield. The wavelength of RFI is usually small and can pass through the 'holes' in a braided shield. EMI is usually larger wavelengths and needs a braided shield to increase the mass of shielding material to be effective.

Aluminum armored cables provide the ultimate in noise immunity as they are basically flexible conduit.

Select the shielded cordset that best meets your needs. If it is easier to tie the shield to ground inside the panel, the foil/drain with the drain not connected inside the cordset is a good choice. If you can connect the drain via a pin inside the device being connected, the foil/drain with the drain connected to a pin is a good choice. Any environments with EMI noise from things like large motors or welding equipment will benefit from a braided shield tied to the coupling nut.

Turck shielded cordsets with the shield tied to the coupling nut offer complete shielding for the entire length of the cordset. A metal sleeve inside the molded body connects the braid/foil shield of the cable to the metal coupling nut with no loss of shielding potential.

Turck armored cordsets are the ultimate in shielded connectors. A Turck patented process allows the interlocked aluminum armor to be connected directly to the coupling nut offering the same protection as running conductors inside metal conduit.

IP Protection Class

IP	Dust Protection						
	0_ Unprotected	1_ Objects ≥ 50 mm	2_ Objects ≥ 12.5 mm	3_ Objects ≥ 2.5 mm	4_ Objects ≥ 1.0 mm	5_ Dust Protected	6_ Dust Tight
_0 Unprotected	IP 00	IP 10	IP 20	IP 30	IP 40	IP 50	IP 60
_1 Dripping Water		IP 11	IP 21	IP 31	IP 41	IP 51	IP 61
_2 Dripping Water on 15° slant		IP 12	IP 22	IP 32	IP 42	IP 52	IP 62
_3 Spraying Water			IP 23	IP 33	IP 43	IP 53	IP 63
_4 Splashing Water				IP 34	IP 44	IP 54	IP 64
_4K Splashing Water High Pressure				IP 34K	IP 44K	IP 54K	IP 64K
_5 Jet Water						IP 55	IP 65
_6 Intense Jet Water						IP 56	IP 66
_6K Intense Jet Water High Pressure						IP 56K	IP 66K
_7 Temporary immersion							IP 67
_8 Continuous immersion as specified by manufacturer							IP 68
_9K Water at high pressure/Steam jet cleaning							IP 69K

We reserve the right to make technical alterations without prior notice.

Water Protection

Reference Section

Ingress Protection Classes- IEC 60529

First ID Number	Protection from penetration of...	Protection from penetration of...
0	Unprotected	N/A
1	Solid Foreign Particles Ø50 mm	No full penetration of sphere with Ø50 mm
2	Solid Foreign Particles Ø12.5 mm	No full penetration of sphere with Ø12.5 mm
3	Solid Foreign Particles Ø2.5 mm	No penetration of rod with Ø2.5 mm
4	Solid Foreign Particles Ø1.0 mm	No penetration of wire with Ø1.0 mm
5	Dust	Dust may only penetrate in such quantity that function and safety are not impacted
6	Dust	No penetration of dust

First ID Number	Protection from penetration of...	Protection from penetration of...
0	Unprotected	N/A
1	Dripping water	Vertically falling drips may not cause any damage
2	Dripping water when the enclosure is in a slanted position of up to 15 °C	Vertically falling drips may not cause any damage
3	Spraying water	Spraying water, which is sprayed in a perpendicular angle of up to 60 °C may not cause any damage
4	Splashing water	Water splashing against the enclosure from every direction may not cause any damage
4K	Splashing water with increased pressure	Water splashing against the enclosure from every direction and with increased pressure may not cause any damage
5	Jet water	Water which is hosed against the enclosure from every direction may not cause damage
6	Intense jet water	Water which is hosed against the enclosure with high intensity may not cause any damage
6K	Intense jet water with increased pressure	Water which is hosed against the enclosure with high intensity and increased pressure may not cause any damage
7	Temporary immersion in water	Water may not enter the enclosure in such quantity as to cause damage when the enclosure is held under water for a set period of time using predetermined pressure (1 m for 30 min)
8	Continuous immersion in water	Water may not enter the enclosure in such quantity as to cause damage when the enclosure is held under water for a set period of time using predetermined pressure (Turck standard is 6' of water, and other chemicals, for a period of 24 hours)
9K	Water at high-pressure/steam jet cleaning	Water which is directed against the enclosure from every direction with extremely high pressure may not cause any damage (14 to 16 l/min at 8,000 to 10,000 kPa)

We reserve the right to make technical alterations without prior notice.

NEMA Standards

NEMA		NEMA 1	NEMA 2	NEMA 12	NEMA 13	NEMA 3	NEMA 3R	NEMA 4	NEMA 4X	NEMA 6	NEMA 6P
Rating Type		Indoor				Outdoor		Indoor/Outdoor			
Protection Against:	Test Number										
Incidental Contact	6.2	•	•	•	•	•	•	•	•	•	•
Falling Dirt	6.2	•	•	•	•	•	•	•	•	•	•
Rust	6.8	•		•	•	•	•	•	•	•	•
Circulating Dust, Lint, Fibers (nonhazardous)	6.5.1.2(2)			•	•	•		•	•	•	•
Windblown Dust	6.5.1.1(2)					•		•	•	•	•
Falling Liquids/Light Splashing	6.3.2.2		•	•	•	•		•	•	•	•
Rain	6.4.2.1					•	•	•	•	•	•
Rain	6.4.2.2					•		•	•	•	•
Snow and Sleet	6.6.2.2					•	•	•	•	•	•
Hose Down and Splashing Water	6.7							•	•	•	•
Occasional Prolonged Submersion	6.11(2)									•	•
Oil and Coolant Drip	6.3.2.2			•	•						
Oil and Coolant, Spray/Splash	6.12				•						
Corrosive Agents	6.9					•	•		•		•

We reserve the right to make technical alterations without prior notice.

Reference Section

NEMA 250 Test Definitions

6.2 Rod Entry Test - a 1/2" diameter rod may not enter the enclosure and a 1/8" rod cannot enter within 4" of live components

6.3 Drip Test - 20 drops per minute for 30 minutes with no water entering enclosure 6.3.2.2 Evaluation, no water shall enter enclosure

6.4 Rain Test - All exposed surfaces are sprayed with 5 psi of water for 60 minutes at a rate of 18" per hour rise in a straight sided pan 6.4.2.1 Evaluation, No water shall have reached live parts, insulation, or mechanisms 6.4.2.2 Evaluation. No water shall have entered enclosure

6.5.1.1 (2) Outdoor Dust Test (alternate method) - Stream of water at 45 gallons per minute from a 1" diameter nozzle, from all directions at a distance from 10' to 12'. Test time is a minimum of 5 minutes. No water shall enter enclosure.

6.5.1.2 (2) Indoor Dust Test (alternate method) - Atomized water at 30 psi is sprayed from all directions from a distance of 12" to 15" at a rate of 3 gallons per hour. No water shall enter enclosure.

6.6 External Icing Test - The enclosure is sprayed with water between 0 °C and 3 °C in a room at 2 °C. The spray is between 1 and 2 gallons per hour per square foot. Spray for 1 hour. The room temp is then dropped to between -7 °C and -3 °C with the spray still going. Ice needs to build up on a test bar at a rate of 1/4 inch per hour. Spray continues until 3/4 inch of ice is on the enclosure. Room temperature is maintained for at least 3 hours. 6.6.2.2 Evaluation, enclosure is undamaged after ice has melted.

6.7 Hose down Test - Stream of water at 65 gallons per minute from a 1" diameter nozzle from all angles at a distance of 10' to 12'. Test time is 48 seconds times (height + width + depth of enclosure in feet) or a minimum of 5 seconds. No water shall enter enclosure.

6.8 Rust Resistance Test - only applicable to enclosures incorporating external ferrous parts

6.9 Corrosion Protection - Test per UL 508, 6.9 or 6.10.

6.11 (2) Air Pressure Test (alternate method) - Enclosure is submerged in water at a pressure equal to a depth of 6' for 24 hours. No water shall enter enclosure.

6.12 Oil Exclusion Test - Stream of test liquid at 2 gallons per minute from a 3/8" nozzle for 30 minutes. Water with 0.1% wetting agent is directed from all angles from a distance of 12" to 18". No test liquid shall enter the enclosure.

Charts

Conversion Chart		
AWG to Metric		
AWG	Diameter (mm)	Section (mm ²)
8	3.26	10
10	2.59	6
12	2.05	4
14	1.63	2.5
16	1.29	1.5
18	1.024	0.75
20	0.813	0.5
22	0.643	0.34
24	0.511	0.25
26	0.405	0.14
28	0.32	0.05
30	0.255	0.05

Thread Conversion Chart	
PG to Metric	
PG	Diameter (mm)
7	12
9	16
11	20
16	25

Cable Length Tolerance Chart	
All Lengths	+4% or 50 mm, whichever is greater than -0 mm
Strip Length	Tolerance(mm)
0-7 mm	±0.5 mm
8-29 mm	±1.0 mm
30-49 mm	±2.0 mm
50-69 mm	±3.0 mm
70-100 mm	±4.0 mm
Over 100 mm	±5.0 mm

We reserve the right to make technical alterations without prior notice.

Reference Section

Installing Cable Products in Accordance with the National Electrical Code (NEC)

The NEC is a set of guidelines for installation of electrical devices, including cables, meant to reduce the risk of electrical shock, fire, etc. The NEC is simply a code, and local laws may or may not require installation based on the NEC. Check local laws for applicability.

The NEC generally does not cover cables installed inside a machine. Any cables installed in an exposed manner, on the outside of a machine or from one machine to something else, must be an approved type and installed in accordance with the appropriate NEC articles.

UL (Underwriters Laboratory) and CSA (Canadian Standards Association) are the primary sources in North America for approving cables to specific standards. While a cable installed within a piece of machinery does not fall under the NEC, most people want to install an approved cable. Turck cables have both UL and CSA approvals. Many of these approvals are the UL AWM (Appliance Wiring) approvals and are acceptable for use in a UL approved device. A UL Listed cable may be installed outside a machine per the NEC standards. UL Listed cables available from Turck include NEC designations for hard duty cables (SOOW, SJOOW, STOOW, SEOW), armored cables (MC), and tray-rated cables (PLTC, ITC).

Hard duty cables designations are:

- S- Service Grade (600 V)
- SJ - Service Grade Junior (300 V)
- ST - Service Grade Thermoplastic (600 V)
- SE - Service Grade Thermoplastic Elastomer (600 V)
- O - Oil resistant jacket material
- OO - Oil resistant jacket and conductor insulation
- W - Weather proof

Turck armored cables are available in 3 different configurations. Type MC cables, type MC cables with ITC/PLTC approvals and simply ITC/PLTC approved. Armored cables with ITC/PLTC approvals may be installed in an exposed run without being offered additional mechanical protection.

Tray-rated cables from Turck include Instrument Tray Cable (ITC) and/or Power Limited Tray Cable (PLTC) or Tray Cable-Exposed Run (TC-ER).

Turck NEC type approved cables are dual listed with other UL type approvals. For example, the RKM 126-*M cordset has a 12 conductor 16 AWG cable with UL AWM 600 V approval and ITC/PLTC approval.

Please refer to the NEC and local laws for specific installation requirements based on your environment.

Cable Applications

Proper management of cabling systems can mean the difference between a dependable and smooth operating installation and costly reoccurring down time. The suggestions outlined below illustrate some of the common sources of problems and provide simple and effective solutions.

RoHS (Restriction of Hazardous Substances in Electrical and Electronic Equipment)

Providing sufficient bend radius will allow the cable to absorb the energy of bending over a greater portion of its length, increasing its effective working life. Small increases in the radius of the bend can produce substantial increases in cable life.

Minimum bend radius for fixed applications:
 Standard cable - 5x cable diameter
 Armorfast® cable - 12x cable diameter

Minimum bend radius for moving applications:
 Standard cable - 10x cable diameter
 Armorfast® cable - 15x cable diameter



Eliminating Stress Points in Cable Dress

Installing cables to allow for adequate stress loops and freedom of motion increase the life of the cables. Turck cordsets incorporate molded strain reliefs that will assist in preventing stress.

Tie Down Loops

Strain Relief

Correct

Incorrect

Correct

Incorrect

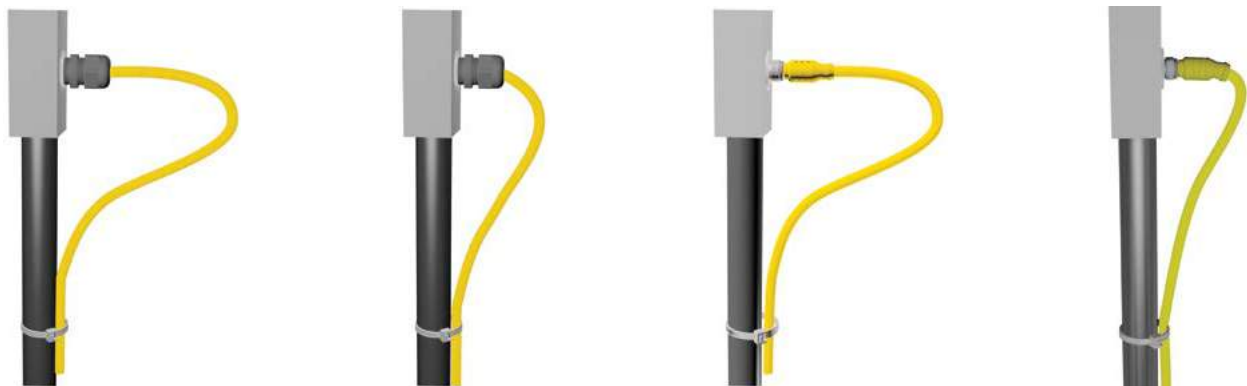

Connectivity Products

Cable Bundling Techniques

When bundling several cables together, always keep the bundle loose enough to move within itself. Tightly tied bundles create both compression and tension stresses when the bundle is moved.

Correct

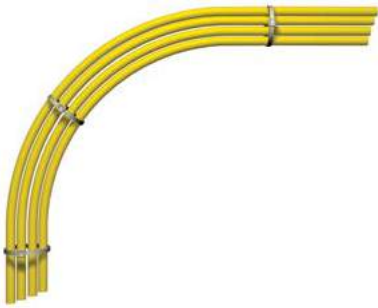

Incorrect



Cabling for Motion Applications

Where cabling is subjected to linear, angular or rotational motion between two points, always allow adequate cable length to absorb the energy imparted by the motion. Use of coiled cords, mechanical support mechanisms, or large, well supported cable loops will maximize cable life.

Coil Cord

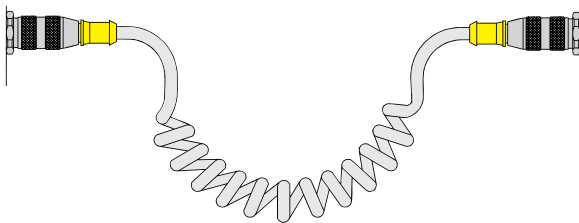

Cable Loop

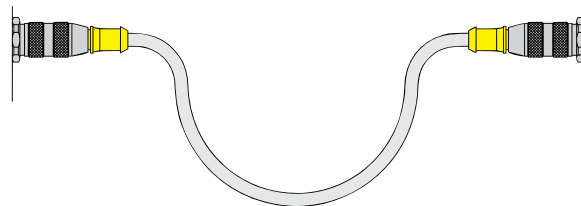

Standard Cable Selection Guide

Selection Criteria	PVC Flexlife®	TPU Flexlife (S90)	CPE Rubber Flexlife (S600)	Weldlife (S1587)	Flexlife-20° TPE (S101)	Flexlife-20 TPU(S90/S101)
Ozone and UV resistance	Excellent	Excellent	Excellent	Excellent	Excellent	Excellent
Temperatures	-40 °C to 105 °C	-40 °C to 90 °C	-50 °C to 105 °C	-60 °C to 105 °C	-60 °C to 105 °C	-40 °C to 90 °C
Cold Bend test	-40 °C	-40 °C	-55 °C	-60 °C	-60 °C	-40 °C
Abrasion & Cut-through resistance	Fair	Excellent	Excellent	Good	Good	Excellent
Flexing (# of cycles)	2 million	2 million	2 million	2 million	20 million+	20 million+
Burn resistance	Good	Excellent	Excellent	Good	Good	Excellent
Oxidation resistance	Excellent	Excellent	Good	Excellent	Excellent	Excellent
Water resistance	Excellent	Excellent	Excellent	Excellent	Excellent	Excellent
Cost	\$	\$\$	\$\$\$	\$\$	\$\$	\$\$
Weld Slag resistance	Poor	Good	Excellent	Excellent	Excellent	Good
Flame Test						
UL Test standards	Horizontal	Vertical Tray	Horizontal	Horizontal/ Vertical Tray	Horizontal/ Vertical Tray	Vertical Tray
CSA Test standards	FT1	FT4	FT1	FT1/FT4	FT1/FT4	FT4
Chemical Resistance						
Acids	Fair/Good	Good	Excellent	Good	Good	Good
Alkalines	Good	Excellent	Excellent	Excellent	Excellent	Excellent
Alcohols	Poor/Fair	Poor/Fair	Excellent	Excellent	Excellent	Poor/Fair
Most Solvents	Poor/Fair	Poor	Good	Poor	Poor	Poor
Oils	Good	Excellent	Excellent	Good	Excellent	Excellent
Gasoline	Poor	Poor	Poor	Poor	Poor	Poor
Greases	Good	Excellent	Excellent	Poor	Poor	Excellent
Available in Cordsets						
Eurofast®	X	X	X	X	X	
Picofast®	X	X		X	X	X
Minifast®	X	X	X	X	X	
Microfast®	X	X	X	X		
Multifast®	X	X		X	X	X
V*fast®	X	X	X	X		

We reserve the right to make technical alterations without prior notice.

Reference Section

Specialty Cable Selection Guide

Selection Criteria	Armorfast MC/ITC	† ITC/PLTC PVC	† ITC/PLTC TPU	ITC/PLTC ER/DB PVC	ITC/PLTC ER/DB TPE
Ozone and UV resistance	Excellent	Excellent	Excellent	Excellent	Excellent
Temperatures	-25 °C to 105 °C	-30 °C to 105 °C	-60 °C to 105 °C	-40 °C to 105 °C	-60 °C to 105 °C
Cold Bend test	-25 °C	-30 °C	-60 °C	-40 °C	-60 °C
Abrasion & Cut-through resistance	Fair	Fair	Excellent	Good	Very Good
Flexing (# of cycles)	2 million	2 million	2 million	2 million	2 million
Burn resistance	Fair/Good	Excellent	Excellent	Excellent	Excellent
Oxidation resistance	Excellent	Excellent	Excellent	Excellent	Excellent
Water resistance	Excellent	Excellent	Excellent	Excellent	Excellent
Cost	\$	\$	\$\$	\$\$	\$\$
Weld Slag resistance	Poor	Good	Good	Poor	Excellent
Flame Test					
UL Test standards	Vertical Tray	Vertical Tray	Vertical Tray	Vertical Tray	Vertical Tray
CSA Test standards	FT4	FT4	FT4	FT4	FT4
IEC Test Standards	60332-3 Cat. A	60332-3 Cat. A	60332-3 Cat. A		
IEEE Test Standards	1202	1202	1202	1202	1202
Chemical Resistance					
Acids	Fair/Good	Fair/Good	Good	Fair/Good	Good
Alkalines	Good	Good	Excellent	Good	Excellent
Alcohols	Poor/Fair	Poor/Fair	Poor/Fair	Poor/Fair	Excellent
Most Solvents	Poor/Fair	Poor/Fair	Poor	Poor/Fair	Poor
Oils	Good	Good	Excellent	Good	Good
Gasoline	Poor	Poor	Poor	Poor	Poor
Greases	Good	Good	Excellent	Good	Poor
Available in Cordsets					
Eurofast®	X	X	X	X	X
Picofast®			X		
Minifast®	X	X	X	X	X
Microfast®			X		
Multifast®		X	X	X	
V*fast®			X		

We reserve the right to make technical alterations without prior notice.

Tying Cables with Cable Ties

When tying cable with self locking cable ties, always leave the ties loose enough for the cables to slide freely under the tie. Over tightening will create stress concentrations that can cause the conductors to fail prematurely. Never tighten the tie to the point where the cable jacket becomes deformed or pinched.

Correct

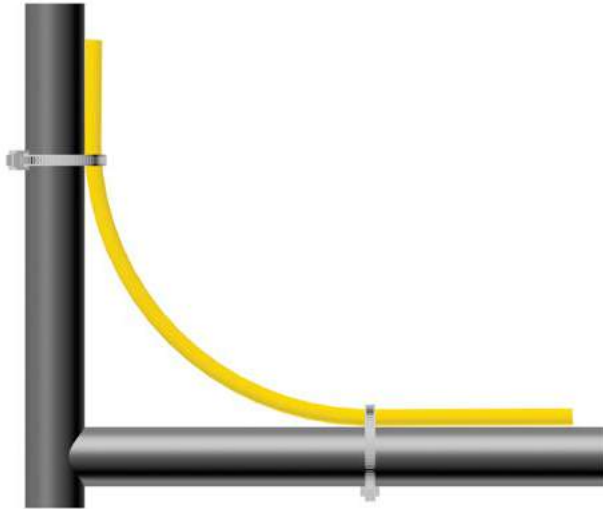

Incorrect

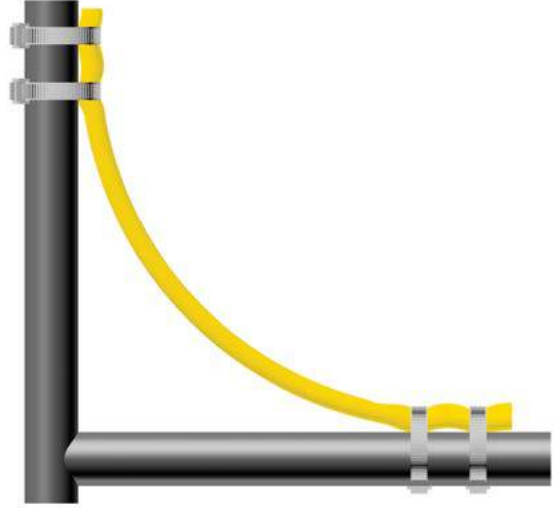

Abrasion Resistance

Ability of wire, cable or material to resist surface wear.

AC Alternating Current

Current in which the charge-flow periodically reverses and is represented by: $I = I_0 \cos(2\pi f + \phi)$ [$I = I_m \cos(\omega t + \phi)$] where I is the current, I_0 is the amplitude, f is the frequency, and ϕ is the phase angle.

Ambient Temperature

The temperature of a medium (gas or liquid) surrounding an object.

Ampere (A)

The unit of current. One ampere is the current flowing through one ohm of resistance at one volt potential.

ANSI

Abbreviation for American National Standards Institute.

Armorfast®

Cordset with metal clad cable (NEC type MC)

Armored Cable

A cable provided with a wrapping of metal for mechanical protection.

AWG (American Wire Gauge)

The standard system used for designating wire diameter. The lower the AWG number, the larger the diameter. Also called the Brown and Sharpe (B&S) wire gauge.

AWM (Appliance Wiring Material)

A UL designation covering insulated wire and cable for internal wiring of appliances and equipment.

Binder

A spirally served tape or thread used for holding assembled cable components in place awaiting subsequent manufacturing operations.

Braid

A fibrous or metallic group of filaments interwoven in cylindrical form to form a covering over one or more wires.

Cable

A stranded conductor with or without insulation and other coverings (single-conductor cable), or a combination of conductors (multiple-conductor cable).

Color Code

Wire or circuit identification by color, utilizing solid colors, tracers, braids, surface printing, etc.

Contact Holder

Insulating device that holds the contacts in their proper position

Conductivity

The ability of a material to allow electrons to flow, measured by the current per unit of voltage applied. It is the reciprocal of resistivity.

Conductor

A wire (or combination of wires not insulated from one another) suitable for carrying electric current.

Conduit

A tube or trough in which insulated wires and cables are run.

Connector

A device used to provide rapid connect / disconnect service for electrical cable and wire terminations.

Contact

The parts of a connector that actually carry the electrical current and that are touched together or separated to control the flow.

Cable

A multiconductor cable made for operation in control circuits.

Cordset

Portable cord fitted with a wiring device at one or both ends.

Cord

A small, flexible insulated cable.

CPE (Chlorinated Polyethylene)

A flexible material with high tear strength and good resistance to most inorganic chemicals. It is inherently difficult to ignite. A Thermoset plastic.

Creepage

The conduction of electricity across the surface of a dielectric.

Crimp Termination

A connection in which a metal sleeve is secured to a conductor by mechanically crimping the sleeve with pliers, presses or automated crimping machines.

Current (I)

The rate of transfer of electricity. Practical unit is the ampere, which represents the transfer of one coulomb per second. In a simple circuit, current (I) produced by a cell or electromotive force (E) when there is an external resistance and internal resistance is:
 $I = E / (R + r)$

Current Carrying Capacity

The maximum current an insulated conductor can safely carry without exceeding its insulation and jacket temperature limitations.

Cut-Through Resistance

The ability of a material to withstand mechanical pressure, usually a sharp edge or small bending radius, without separation.

Dielectric Strength

The voltage that an insulator can withstand before breakdown occurs. Usually expressed as a voltage gradient (such as volts per mil).

Direct Current (DC)

An electric current that flows in only one direction.

Drain Wire

In a cable, the bare wire laid over the component or components and used as a ground connection.

Earth

British terminology for zero-reference ground.

Eurofast®

M12 threads, single key, 2 - 6, 8, 10, 12 pin

Extruded Cable

Cable with conductors that are uniformly insulated and formed by applying a homogeneous insulation material in a continuous extrusion process.

Fillers

Non-conducting components cabled with the insulated conductors or optical fibers to impart roundness, flexibility, tensile strength, or a combination of all three, to the cable.

Firefast®

High temperature protective sleeving.

Ground

An electrical connection to the earth, generally through a ground rod. Also a common return to a point of zero potential, such as the metal chassis of equipment.

Glossary of Terms

Ground Loop

A completed circuit between shielded pairs of a multiple pair created by random contact between shields. An undesirable circuit condition in which interference is created by ground currents when grounds are connected at more than one point.

Ground Potential

The potential of the earth. A circuit, terminal or chassis is said to be at ground potential when it is used as a reference point for other potentials in the system.

Hygroscopic

Capable of absorbing moisture from the air.

IEC

European Standardization agency; International Electrotechnical Commission.

Input

A signal (or power) which is applied to a piece of electrical apparatus or the terminals on the apparatus to which a signal or power is applied.

Insulation

A material having good dielectric properties that is used to separate close electrical components, such as cable conductors and circuit components.

ITC

Instrument Tray Cable. NEC classification for cable resistant to the spread of fire and suitable for use in cable trays. 150 V rating.

Irradiation

In insulation, the exposure of the material to high-energy emissions for the purpose of favorably altering the molecular structure.

Jacket

Pertaining to wire and cable, the outer protective covering, may also provide additional insulation.

LED

Light Emitting Diode used to indicate device status.

Line Voltage

The value of the potential existing on a supply or power line.

Load

A device that consumes power from a source and uses that power to perform a function.

MC

Metal Clad Cable. NEC classification for cable resistant to crush and impact based on an outer covering of metal.

Microfast®

½"-20 UNF threads, dual key, 2-6 pin

Minifast®

7/8"-16UN threads, 2 - 6 pin

Minifast B size

1"-16 UN threads, 6-8 pin

Minifast C size

1 1/8"-16 UN threads, 9, 10, 12 pin

Moisture Resistance

The ability of a material to resist absorbing moisture from the air or from water when immersed.

Molded Plug

A connector molded onto either end of a cord or cable.

MOV

Acronym for Metal Oxide Varistor. A solid state device used to suppress voltage surges \ spikes

MSHA

Mine Safety and Health Administration

Multibox®

Junction boxes, 4, 6, 8 and 16 port

Multifast®

M23 threads, 12, 16 and 19 pin or M27 threads, 26 and 28 pin

Mylar

DuPont trademark for polyester film.

National Electrical Code (NEC)

A set of regulations governing construction and installation of electrical wiring and apparatus in the United States, established by the American National Board of Fire Underwriters.

NEMA

National Electrical Manufacturers Association.

Neoprene

A synthetic rubber with good resistance to oil, chemical, and flame. Also called polychloroprene. A Thermoset plastic.

Noise

In a cable or circuit, any extraneous signal that tends to interfere with the signal normally present in or passing through the system.

NPN Output

Transistor output that switches the common or negative voltage to the load (current sinking). Load connected between output and positive supply.

Ohm (Ω)

The electrical unit of resistance. The value of resistance through which a potential difference of one volt will maintain a current of one ampere.

Ohm's Law

$E = I \times R$. Voltage (E) is directly proportional to the product of current (I) and resistance of circuit.

Output

The useful power or signal delivered by a circuit or device.

PA (Polyamide, Nylon)

An abrasion-resistant thermoplastic with good chemical resistance, also known as polyamide.

Pentafast®

M5 threads, 3 and 4 pin

Picofast®

Snap lock or M8 threads, 3, 4 and 6 pin

Plastic

High-polymeric substances, including both natural and synthetic products, but excluding the rubbers, that are capable of flowing under heat and pressure.

Plug

A connector associated with being attached to a cable.

PLTC

Power Limited Tray Cable. NEC classification for cable resistant to the spread of fire and suitable for use in cable trays. 300 V rating.

PNP Output

Transistor output that switches the positive voltage to the load (current sourcing). Load connected between output and common.

POM (Polyoxymethylene, Acetal, Delrin)

Polyoxymethylene - a crystalline thermoplastic polymer with a high melting point. It is suitable for mechanical parts or electrical insulators that require structural strength at above normal temperatures.

Potting

The sealing of a cable termination or other component with a liquid that thermosets into an elastomer.

PUR (Polyurethane)

Broad class of polymers noted for good abrasion and solvent resistance.

PVC (Polyvinyl Chloride)

A general-purpose thermoplastic widely used for wire and cable insulation and jackets.

Powerfast

1 3/8"-16 threads, 2, 3 and 4 pin or M23 threads, 6, 7 and 9 pins or M40 threads, 4-pin.

Resistance

A measure of the difficulty in moving electrical current through a medium when voltage is applied. It is measured in ohms.

Retractable Cord

A cord having a specially treated jacket or insulation so that it will retract like a spring. Retractility may be added to all or part of a cord's length.

RoHS

(Restriction of Hazardous Substances).

Rubber

A general term used to describe wire insulation made of thermosetting elastomers, such as natural or synthetic rubbers, neoprene, Hypalon, CPE butyl rubber and others.

Shield

In cables, a metallic layer placed around a conductor or group of conductors to prevent electrostatic or electromagnetic interference between the enclosed wires and external fields.

Signal

Any visible or audible indication that can convey information. Also, the information conveyed through a communication system.

SJOOW

Junior hard service, rubber insulated, portable cord with oil resistant rubber outer jacket. Stranded copper conductors with separator and individual oil and water resistant rubber insulation. Two or more color coded conductors cabled with filler, wrapped with separator and rubber jacketed overall. 300 V.

Solid Conductor

A conductor consisting of a single wire.

Solid State

Pertains to circuits and components using semiconductors without moving parts. Example: transistors, diodes, SCR, etc.

SOOW

Heavy duty, rubber-insulated portable cord with oil resistant rubber outer jacket. Stranded copper conductors with separator and individual oil and rubber insulation. Two or more color-coded conductors cabled with filler, wrapped with separator and rubber jacketed overall. 600 V.

STOW

Heavy duty, PVC insulated, portable cord with oil resistant PVC outer jacket. Stranded copper conductors, PVC insulation. Two or more color coded conductors cabled with filler, wrapped with separator and PVC jacketed overall. Approved for outdoor use. 600 V.

Stranded Conductor

A conductor composed of groups of wires twisted together.

Temperature Rating

The maximum temperature at which a material may be used in continuous operation without loss of its basic properties.

Thermoplastic

A material that will soften, flow or distort appreciably when subjected to heat and pressure.

Thermoset

A material that hardens or sets when heat is applied, and which, once set, cannot be re-softened by heating. The application of heat is called "curing".

TPE

Thermo Plastic Elastomer. Broad class of polymers noted for flexibility and weld slag resistance.

TPR

Thermo Plastic Rubber. Another name for TPE.

Twisted Pairs

A cable composed of two small, insulated conductors twisted together without a common covering.

Versafast™

M16 threads, 5, 6, 7, 8, 12, 14 and 19 pin

V*fast®

DIN 43650, type A, B, I and C

VDE

German approval agency.

Volt (V)

A unit of electrical pressure. One volt is the electrical pressure that will cause one ampere of current to flow through one ohm of resistance.

Voltage

The term most often used in place of electromotive force, potential difference, or voltage drop. Designates the electric pressure existing between two points that is capable of producing a current when a closed circuit is connected between these points.

Voltage Rating

The highest voltage that may be continuously applied to a wire in conformance with standards or specifications.

VW-1

A flammability rating established by Underwriters Laboratories for wires and cables that pass a specially designed vertical flame test, formerly designated FR-1.

Wicking

The longitudinal flow of a liquid in a wire or cable due to capillary action.

Warranty Terms and Conditions

RISK OF LOSS

Delivery of the equipment to a common carrier shall constitute delivery to the Purchaser and the risk of loss shall transfer at that time to Purchaser. Should delivery be delayed due to an act or omission on the part of the Purchaser, risk of loss shall transfer to the Purchaser upon notification by Turck Inc. that the order is complete and ready for shipment.

WARRANTIES

Turck Inc. (hereinafter "Turck") offers five (5) WARRANTIES to cover all products sold. They are as follows:

- 1) The **12-MONTH WARRANTY** is available for the products listed - generally those not covered by **LIFETIME, 5-YEAR, 24-MONTH or 18-MONTH** warranty. No registration required.
- 2) The **18-MONTH WARRANTY** is available for the products listed - generally those not covered by **LIFETIME or 5-YEAR WARRANTY**. No registration is required.
- 3) The **24-MONTH WARRANTY** is available for the products listed - generally those not covered by **LIFETIME, 5-YEAR or 18-MONTH**. No registration is required.
- 4) The **5-YEAR WARRANTY** is available generally for the products listed. No registration is required.
- 5) A **LIFETIME WARRANTY** is available for the products listed. It becomes effective when the accompanying **TURCK LIFETIME WARRANTY REGISTRATION** is completed and returned to Turck.

GENERAL TERMS AND CONDITIONS FOR ALL WARRANTIES

- **12-MONTH STANDARD WARRANTY**
- **18-MONTH STANDARD WARRANTY**
- **24-MONTH STANDARD WARRANTY**
- **5-YEAR WARRANTY**
- **LIFETIME WARRANTY**

Turck warrants the Products covered by the respective WARRANTY AGREEMENTS to be free from defects in material and workmanship under normal and proper usage for the respective time periods listed above from the date of shipment from Turck. In addition, certain specific terms apply to the various WARRANTIES.

THESE EXPRESS WARRANTIES ARE IN LIEU OF AND EXCLUDE ALL OTHER REPRESENTATIONS MADE - BOTH EXPRESSED AND IMPLIED. THERE ARE NO WARRANTIES OF MERCHANTABILITY OR OF FITNESS FOR A PARTICULAR PURPOSE FOR PRODUCTS COVERED BY THESE TERMS AND CONDITIONS.

Turck warrants that the goods sold are as described, but no promise, description, affirmation of fact, sample model or representation, oral or written shall be part of an order, unless set forth in these terms and conditions, or are in writing and signed by an authorized representative of Turck. These WARRANTIES do not apply to any Product which has been subject to misuse, negligence, or accident - or to any Product which has been modified or repaired, improperly installed, altered, or disassembled - except according to Turck's written instructions.

These WARRANTIES are subject to the following conditions:

- 1) These WARRANTIES are limited to the electronic and mechanical performance only, as expressly detailed in the Product specifications and NOT to cosmetic performance.
- 2) These WARRANTIES shall not apply to any cables attached to, or integrated with the Product. However, the **18-MONTH WARRANTY** shall apply to cables sold separately by Turck.
- 3) These WARRANTIES shall not apply to any Products which are stored, or utilized, in harsh environmental or electrical conditions outside Turck's written specifications.
- 4) The WARRANTIES are applicable only to Products shipped from Turck subsequent to January 1, 1988.

ADDITIONAL SPECIFIC TERMS FOR:

(12-MONTH STANDARD WARRANTY) for Linear Displacement Transducers, EZ Track, RFID Products, Draw Wire Assemblies and Slip Rings.

(18-MONTH STANDARD WARRANTY) FOR Q-TRACK INDUCTIVE SENSORS, ULTRASONIC SENSORS, FLOW SENSORS, PRESSURE SENSORS, TEMPERATURE SENSORS, INCLINOMETERS, CABLES AND ALL NON-SENSING PRODUCTS SOLD BY TURCK INC. INCLUDING MULTI-SAFE, MULTI-MODUL, MULTI-CART AND RELATED AMPLIFIER PRODUCTS, RELAYS AND TIMERS.

(24-MONTH STANDARD WARRANTY) FOR ENCODERS excluding Draw Wire Assemblies.

5-YEAR WARRANTY FOR INDUCTIVE AND CAPACITIVE PROXIMITY SENSORS: The periods covered for the above WARRANTIES and Products shall be 12 MONTHS, 18-MONTHS, 24-MONTHS and 5-YEARS, respectively, from the date of shipment from Turck.

LIFETIME WARRANTY (OPTIONAL - REGISTRATION REQUIRED) FOR INDUCTIVE, INDUCTIVE MAGNET OPERATED AND CAPACITIVE PROXIMITY SENSORS SOLD TO THE ORIGINAL PURCHASER FOR THE LIFETIME OF THE ORIGINAL APPLICATION.

Connectivity Products

Warranty Terms and Conditions

THE FOLLOWING TERMS APPLY TO THE LIFETIME WARRANTY IN ADDITION TO THE GENERAL TERMS:

- 1) This WARRANTY shall be effective only when the LIFETIME WARRANTY REGISTRATION has been completed, signed by the End User and an authorized Turck Representative or Distributor and has been received by Turck no later than six (6) months after installation in the End User's Plant, or two (2) years from the date product was shipped from Turck, whichever is sooner.
- 2) This warranty is available only to Turck's authorized Representatives, Distributors and to the Original User. (The term "Original User" means that person, firm, or corporation which first uses the Product on a continuous basis in connection with the operation of a production line, piece of machinery, equipment, or similar device.) In the event the ownership of the product is transferred to a person, firm or corporation other than the Original User, this WARRANTY shall terminate.
- 3) This WARRANTY is applicable only to the Original Application. In the event the machinery, equipment, or production line to which the Product is connected, or on which it is installed, is substituted, changed, moved or replaced, the WARRANTY shall terminate.
- 4) This WARRANTY shall be valid only if the Product was purchased by the Original User from Turck, or from an authorized Turck Distributor, or was an integral part of a piece of machinery and equipment obtained by the Original user from an Original Equipment Manufacturer, which itself, was purchased directly from Turck or from an authorized Distributor.

PURCHASER'S REMEDIES

This Remedy shall apply to all WARRANTIES. If a Turck Distributor desires to make a WARRANTY Claim, the Distributor shall, if requested by Turck, ship the Product to Turck's factory in Minneapolis, Minnesota, postage or freight prepaid. If the User desires to make a WARRANTY Claim, they shall notify the authorized Turck Distributor from whom it was purchased or, if such Distributor is unknown, shall notify Turck. Turck shall, at its option, take any of the following two courses of action for any products which Turck determines are defective in materials or workmanship.

- 1) Repair or replace the Product and ship the Product to the Original Purchaser or to the authorized Turck Distributor, postage or freight prepaid; or
- 2) Repay to the Original Purchaser that price paid by the Original Purchaser; provided that if the claim is made under the LIFETIME WARRANTY, and such Product is not then being manufactured by Turck, then the amount to be repaid by Turck to the Original Purchaser shall be reduced according to the following schedule:

<u>Number of Years Since Date of Purchase by Original Purchaser</u>	<u>Percent of Original Purchase Price To Be Paid by Turck</u>
10	50%
15	25%
20	10%
More than 20	5%

PURCHASER'S REMEDIES SHALL BE LIMITED EXCLUSIVELY TO THE RIGHT OF REPLACEMENT, REPAIR OR REPAYMENT AS PROVIDED AND DOES NOT INCLUDE ANY LABOR COST OR REPLACEMENT AT ORIGINAL PURCHASER'S SITE. TURCK SHALL NOT BE LIABLE FOR ANY CONSEQUENTIAL DAMAGES RESULTING FROM ANY BREACH OF ANY WARRANTY, EXPRESSED OR IMPLIED, APPLICABLE TO THE PRODUCT, INCLUDING WITHOUT LIMITATION, ANY DAMAGES RESULTING FROM PROPERTY DAMAGE, PERSONAL INJURY OR BUSINESS INTERRUPTION.

CONSIDER SAFETY AND PROTECTION PRECAUTIONS

Turck takes great care to design and build reliable and dependable products, however, some products can fail eventually. You must take precautions to design your equipment to prevent property damage and personal injury in the unlikely event of failure. As a matter of policy, Turck does NOT recommend the installation of electronic controls as the sole device FOR THE PROTECTION OF PERSONNEL in connection with power driven presses, brakes, shears and similar equipment and, therefore, the customer should build in redundancy or dual control using approved safety devices for these applications.

TURCK PRODUCTS

Turck Inc. sells its products through authorized distributors. These distributors provide our customers with technical support, service and local stock. Turck distributors are located nationwide – including all major metropolitan marketing areas.

For application assistance or for the location of your nearest Turck distributor, call:

1-800-544-7769

Specifications in this manual are subject to change with out notice. Turck also reserves the right to make modifications and makes no guarantee of the accuracy of the information contained herein.

Literature and media questions or concerns?
Contact Turck USA Marketing – info@turck.com

TURCK

30 subsidiaries and over
60 representations worldwide!

Printed in USA

©2020 by Turck Inc. All rights reserved. No part of the
publication may be reproduced without written permission.

B2007 C 10/20

www.turck.com