

Your Global Automation Partner

TURCK

NIC...-M30

Inductive Coupler

Instructions for Use



Contents

1	About these Instructions	5
1.1	Target groups	5
1.2	Explanation of Symbols Used	5
1.3	Other documents	5
1.4	Feedback about these instructions	5
2	Notes on the Product	6
2.1	Product identification	6
2.2	Scope of delivery	6
2.3	Legal requirements	6
2.3.1	Device classification according to SRD EN 300 440	6
2.4	Manufacturer and Service	7
3	For Your Safety	8
3.1	Intended use	8
3.2	General safety notes	8
4	Product Description	9
4.1	Device overview	9
4.1.1	Indication elements	9
4.2	Properties and features	9
4.3	Operating principle	9
4.4	Functions and operating modes	10
4.4.1	Transfer of 2 standard PNP signals	10
4.4.2	IO-Link mode	10
4.4.3	Transfer of 8 standard PNP signals	11
4.4.4	Foreign object detection – FOD	11
4.5	Technical accessories	12
5	Mounting	13
5.1	Power with angle offset	13
5.2	Power with lateral offset	14
5.3	Distance between primary side and secondary side	14
6	Connecting	15
6.1	Transfer of 2 standard PNP signals (digital inputs)	15
6.2	IO-Link mode	15
6.3	Transfer of 8 standard PNP signals	16
7	Commissioning	17
7.1	IO-Link mode	17
8	Operation	18
8.1	LEDs	18
8.2	Foreign object detection (FOD)	18
9	Troubleshooting	19
10	Maintenance	20
11	Repair	20
11.1	Returning Devices	20

12	Decommissioning	20
13	Disposal	20
14	Technical Data	21
14.1	Technical data of the primary side	21
14.2	Technical data of the secondary side	21
14.3	Technical data of inductive transfer system	22
14.4	Design	22
15	Appendix: EU Declaration of Conformity	23

1 About these Instructions

These operating instructions describe the structure, functions and the use of the product and will help you to operate the product as intended. Read these instructions carefully before using the product. This is to avoid possible damage to persons, property or the device. Retain the instructions for future use during the service life of the product. If the product is passed on, pass on these instructions as well.

1.1 Target groups

This document is written for specially trained personnel, and must be read carefully by anyone who is responsible for the mounting, commissioning, operation, maintenance, disassembly or disposal of the device.

1.2 Explanation of Symbols Used

The following symbols are used in these instructions:



DANGER

DANGER indicates a dangerous situation with high risk of death or severe injury if not avoided.



WARNING

WARNING indicates a dangerous situation with medium risk of death or severe injury if not avoided.



CAUTION

CAUTION indicates a dangerous situation of medium risk which may result in minor or moderate injury if not avoided.



NOTICE

NOTICE indicates a situation which may lead to property damage if not avoided.



NOTE

NOTE indicates tips, recommendations and useful information on specific actions and facts. The notes simplify your work and help you to avoid additional work.



CALL TO ACTION

This symbol denotes actions that the user must carry out.



RESULTS OF ACTION

This symbol denotes relevant results of actions.

1.3 Other documents

- Data sheet
- Declaration of Conformity
- IO-Link devices commissioning manual

1.4 Feedback about these instructions

We make every effort to ensure that these instructions are as informative and as clear as possible. If you have any suggestions for improving the design or if some information is missing in the document, please send your suggestions to techdoc@turck.com.

2 Notes on the Product

2.1 Product identification

NIC P - M30 - IOL 2P8X H1141

NIC	Functional Principle	P	Component	-	M30	Design	-
	Functional principle NIC Non-flush inductive coupler		Component P Primary side (Emitter) S Secondary side (Receiver)			Design M30 M30 × 1.5 threaded barrel	

IOL	Technology	2	P	8	X	Electrical Version	-	H1141	Electrical Connection
	Technology IOL IO-Link					Indication X LED Voltage range 8 24 VDC, short-circuit proof Output mode P PNP Number of channels 2 2 channels 8 8 channels			Electrical connection H1141 Integrated connector, M12 × 1, 4-pin 0.3-RKC4.4T Pigtail: 0.3 m cable with female connector, M12 × 1, 4-pin 0.3-RSC12T Pigtail: 0.3 m cable with male connector, M12 × 1, 12-pin

2.2 Scope of delivery

- Primary side or secondary side
- 2 M30 nuts for mounting

2.3 Legal requirements

The device is subject to the following EC directives:

- 2014/53/EU (RED Directive)
- 2011/65/EU (RoHS II Directive)

2.3.1 Device classification according to SRD EN 300 440

The device complies with the following classifications according to ETSI EN 300 440:

- Receiver category 3
- Generic short range device

2.4 Manufacturer and Service

Hans Turck GmbH & Co. KG
Witzlebenstraße 7
45472 Muelheim an der Ruhr
Germany

Turck supports you with your projects, from initial analysis to the commissioning of your application. The Turck product database contains software tools for programming, configuration or commissioning, data sheets and CAD files in numerous export formats. You can access the product database at the following address: www.turck.de/products
For further inquiries in Germany contact the Sales and Service Team on:

- Sales: +49 208 4952-380
- Technology: +49 208 4952-390

Outside Germany, please contact your local Turck representative.

3 For Your Safety

The product is designed according to state-of-the-art technology. However, residual risks still exist. Observe the following warnings and safety notices to prevent damage to persons and property. Turck accepts no liability for damage caused by failure to observe these warning and safety notices.

3.1 Intended use

These devices are designed solely for use in industrial areas.

Inductive couplers are used for the contactless and bidirectional transfer of power and data via an air interface (max. 7 mm) in industrial automation applications. The devices consist of a primary side and a secondary side. The primary side supplies power to the secondary side via an air interface. The secondary side supplies in turn data from the connected sensors as well as sensors and actuators connected in IO-Link mode.

The devices may only be used as described in these instructions. Any other use is not in accordance with the intended use. Turck accepts no liability for any resulting damage.

3.2 General safety notes

- The device only meets the EMC requirements for industrial areas and is not suitable for use in residential areas.
- The device may only be assembled, installed, operated, parameterized and maintained by professionally-trained personnel.
- The device may only be used in accordance with applicable national and international regulations, standards and laws.
- Do not place any metal objects such as screw drivers in the electrical field between the primary and secondary side.

4 Product Description

The devices have a cylindrical housing style with an M30 × 1.5 male thread. An M12 connector (male) directly on the housing is used to connect the NICP-M30-IOL2P8X-H1141 primary side. The NICP-M30-8P8-0,3-RSC12T primary side and the NICS-M30-IOL2P8-0,3-RKC4.4T secondary side are provided with a 0.3 m connection cable with an M12 male connector (pigtail).

4.1 Device overview

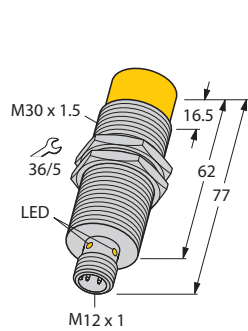

Fig. 1: Primary side NICP-M30-IOL2P8X-H1141

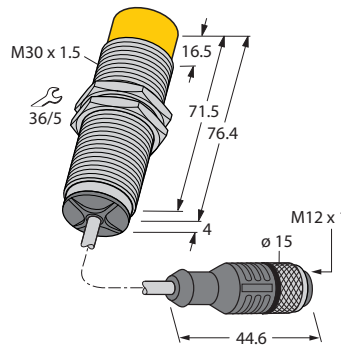

Fig. 2: Primary side NICP-M30-8P8-0,3-RSC12T

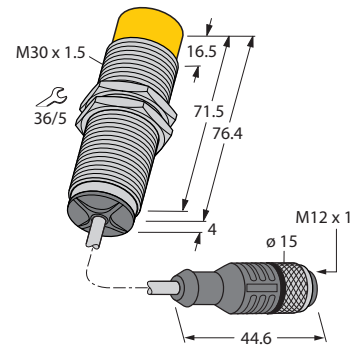

Fig. 3: Secondary side NICS-M30-IOL2P8-0,3-RKC4.4T

4.1.1 Indication elements

The NICP-M30-IOL2P8X-H1141 primary side is provided with an LED for status indication.

4.2 Properties and features

- Threaded barrel, M30 × 1.5
- Chrome-plated brass
- DC 4-wire, 24 VDC

4.3 Operating principle

Inductive couplers transfer power based on the principle of inductive coupling power transfer – ICPT. The oscillation frequency is 200 kHz. Data is transferred on a carrier frequency of 2.4 GHz.

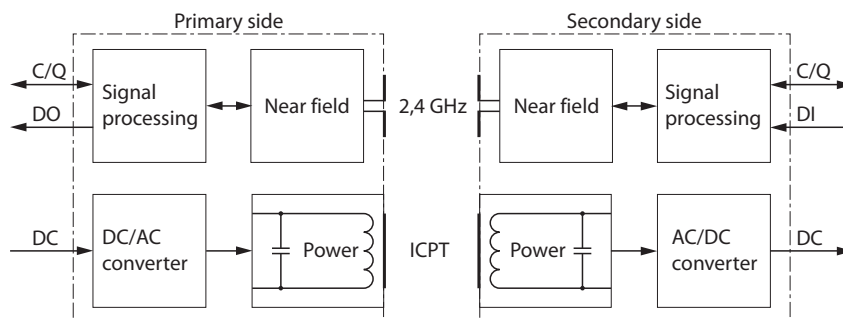

Fig. 4: Block diagram

Inductive couplers consist of a primary side and a secondary side. The devices are used for the contactless and bidirectional transfer of power and data via an air interface (max. 7 mm) in industrial environments. The primary side supplies power to the secondary side via an air interface. The secondary side supplies in turn data from the connected sensors as well as sensors and actuators connected in IO-Link mode.

4.4 Functions and operating modes

The inductive couplers can be used to transfer 2 or 8 standard PNP signals or can be run in IO-Link mode. Different primary sides of the inductive coupler must be used depending on the operating mode.

4.4.1 Transfer of 2 standard PNP signals

To transfer 2 standard PNP signals, the devices NICP-M30-IOL2P8X-H1141 (primary) and NICS-M30-IOL2P8-0,3-RKC4.4T (secondary) are required. The secondary side with a connected VB2-FSM4.4-2FKM4 junction system (Ident no. 6930560) transfers 2 standard PNP signals to the primary side. The junction system is not required if sensors with 2 PNP outputs (e.g. power clamps) are used.

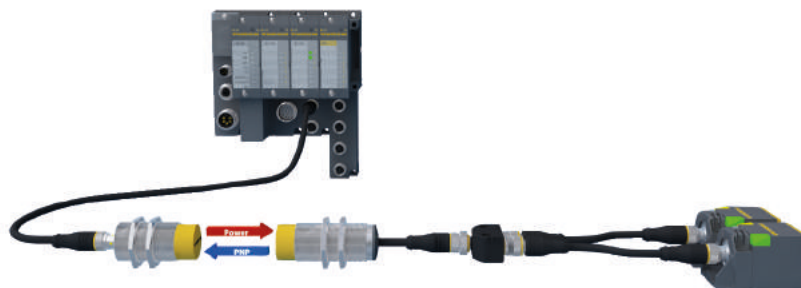

Fig. 5: Setup example for the transfer of 2 standard PNP signals

4.4.2 IO-Link mode

The devices NICP-M30-IOL2P8X-H1141 (primary) and NICS-M30-IOL2P8-0,3-RKC4.4T (secondary) are required for IO-Link mode. IO-Link mode provides a bidirectional IO-Link communication between an IO-Link master and an IO-Link device via the air interface.



Fig. 6: Setup example for IO-Link communication

4.4.3 Transfer of 8 standard PNP signals

The following devices are required for the transfer of 8 standard PNP signals:

- NICP-M30-8P8-0,3-RSC12T (primary side)
- NICS-M30-IOL2P8-0,3-RKC4.4T (secondary side)
- TBIL-M1-16DIP (I/O hub for IO-Link)

If the secondary side is connected to a TBIL-M1-16DIP I/O hub for IO-Link, up to 8 standard PNP signals can be transferred via the inductive coupler. For this a PNP sensor is connected to the ports of the TBIL-M1-16DIP on channel A. The PNP signals of the sensors on the primary side can be connected to a digital input card via the plug connector on the device.

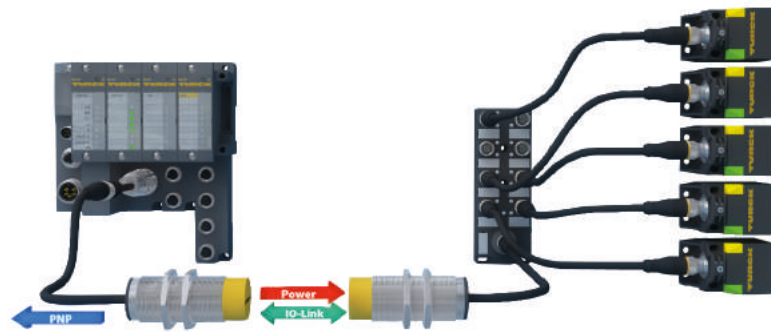

Fig. 7: Setup example for the transfer of 8 standard PNP signals

4.4.4 Foreign object detection – FOD

The FOD function (Foreign Object Detection) detects metallic foreign objects between the primary and secondary side. The power supply of the device is switched off if the FOD detects foreign objects.

4.5 Technical accessories

Ident No.	Type	Description
6814017	TBEN-L5-8IOL	Compact multiprotocol I/O module for Ethernet, 8 IO-Link master channels, 4 universal digital PNP channels, 2 A, channel diagnostics
6814024	TBEN-S2-4IOL	Compact multiprotocol I/O module for Ethernet, 4 IO-Link master channels, 4 universal digital PNP channels, 0.5 A, channel diagnostics
6814102	TBIL-M1-16DXP	I/O hub for IO-Link, 16 universal digital PNP channels (only in connection with primary side NICP-M30-IOL2P8X-H1141)
6814100	TBIL-M1-16DIP	I/O hub for IO-Link, 16 digital PNP inputs
6814101	TBIL-M1-8DOP	I/O hub for IO-Link, 8 digital outputs (only in connection with primary side NICP-M30-IOL2P8X-H1141)
6827386	BL67-4IOL	IO-Link 1.1 master for BL67 modular fieldbus system, 4 IO-Link ports and 4 programmable PNP ports
6827385	BL20-E-4IOL	IO-Link 1.1 master for BL20 modular fieldbus system, 4 IO-Link ports and 4 programmable PNP ports
6825482	USB-2-IOL-0002	IO-Link 1.1 adapter with integrated USB interface, 1-channel operation in IOL or SIO mode
6625503	RKC4.4T-2/TXL	Connection cable, M12 female connector, straight, 4-pin, cable length: 2 m, sheathing material: PUR, black
6625339	RKC12T-2/TXL	Connection cable, M12 female connector, straight, 12-pin, cable length: 2 m, sheathing material: PUR, black
6625608	RKC4.4T-2-RSC4.4T/TXL	Connection cable, M12 female connector, straight 4-pin, cable length 2 m, M12 plug connector, straight, 4-pin sheathing material PUR, black
6932705	RKC12T-2-CS19.121/TXL	Connection cable, M12 female connector, straight 12-pin, cable length 2 m, M23 plug connector, straight, 19-pin, for direct connection to BL67 base module with M23 plug connector

5 Mounting

The maximum tightening torque of the housing nuts is 40 Nm.

- ▶ Check whether the housing material and the degree of protection is sufficient for your application in terms of resistance, vibration resistance and cleaning (see chapter 14, Technical Data).
- ▶ Align the front faces of the primary and secondary side to each other. Observe here the tables "Power with angle offset", "Power with lateral offset" and "Distance between primary and secondary side".
- ▶ Fit the device at the intended mounting location. Observe the minimum mounting distances.

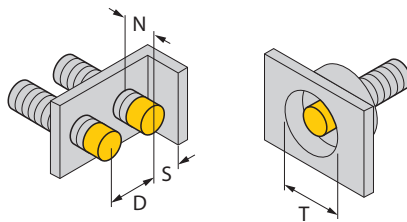

Fig. 8: Mounting distances

Distance	
T	60 mm
N	26.5 mm
S	30 mm
D	60 mm

5.1 Power with angle offset

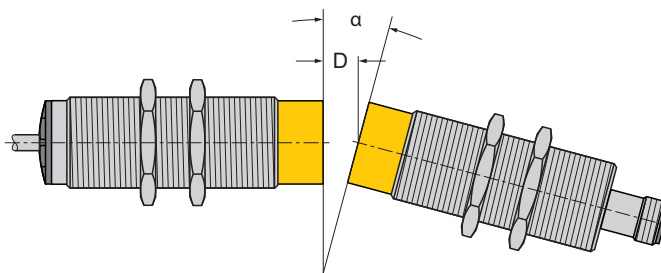

Fig. 9: Angle offset

Distance D	Angle α	Power
2 mm	7.5°	12 W
4 mm	15°	12 W
5 mm	20°	12 W
7 mm	25°	12 W
8 mm	30°	1 W

5.2 Power with lateral offset

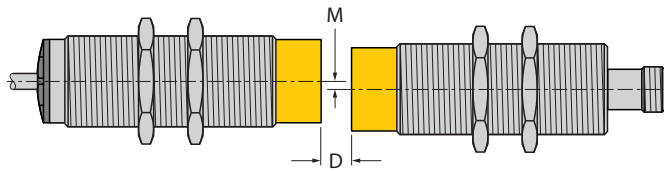

Fig. 10: Lateral offset between primary side (right) and secondary side (left)

Distance D	Offset M	Power
0 mm	5 mm	12 W
2 mm	5 mm	12 W
4 mm	5 mm	12 W
5 mm	3 mm	12 W
7 mm	2 mm	12 W
8 mm	1 mm	1 W

5.3 Distance between primary side and secondary side

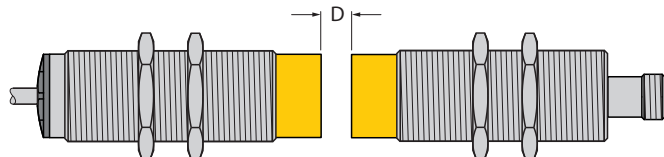

Fig. 11: Distance between primary side (right) and secondary side (left)

Distance D	Power
0 mm	12 W
2 mm	12 W
4 mm	12 W
6 mm	12 W
7 mm	12 W
8 mm	1 W

6 Connecting

6.1 Transfer of 2 standard PNP signals (digital inputs)

- ▶ Connect sensors (e.g. to a VB2-FSM4.4-2FKM4 2-port junction system).
- ▶ Connect NICS-M30-IOL2P8-0,3-RKC4.4T on the secondary side to a sensor as per the pin layout.
- ▶ Connect the primary side NICP-M30-IOL2P8X-H1141 to a controller or a fieldbus device via an M12 connection cable (e.g. RKC4.4T-2/TXL) as per the pin layout.

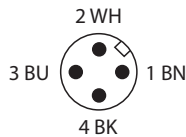

Fig. 12: Pin layout, primary side

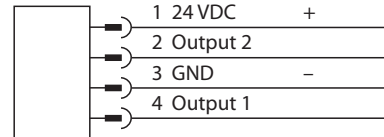

Fig. 13: Wiring diagram, primary side

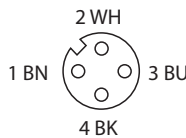

Fig. 14: Pin layout, secondary side

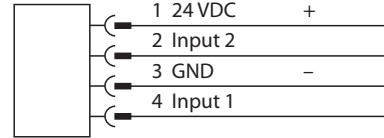

Fig. 15: Wiring diagram, secondary side

6.2 IO-Link mode



NOTE

In IO-Link mode contact 2 cannot be used as a digital input or output.

- ▶ Connect the secondary side NICS-M30-IOL2P8-0,3-RKC4.4T to an IO-Link device as per the pin layout.
- ▶ Connect the primary side NICP-M30-IOL2P8X-H1141 to an IO-Link master via an M12 connection cable (e.g. RKC4T.T-2/TXL) as per the pin layout.

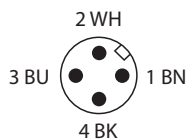

Fig. 16: Pin layout, primary side

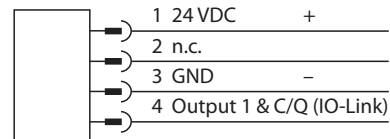

Fig. 17: Wiring diagram, primary side

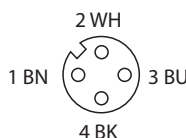

Fig. 18: Pin layout, secondary side

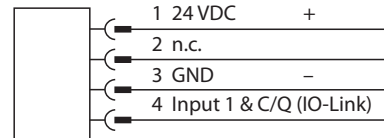

Fig. 19: Wiring diagram, secondary side

6.3 Transfer of 8 standard PNP signals



NOTICE

2 NICP-M30-8P8-0.3-RSC12T devices on a digital input module

Damage to devices due to overcurrent

- ▶ Never connect 2 NICP-M30-8P8-0.3-RSC12T devices in parallel to a digital input module.

- ▶ Connect sensors to the respective ports of the I/O hub for IO-Link TBIL-M1-16DIP (Ident no. 6814100). Use here channel A (Pin 4).
- ▶ Connect the secondary side NICS-M30-IOL2P8-0,3-RKC4.4 to the TBIL-M1-16DIP IO-Link hub as per the pin layout.
- ▶ Connect the primary side NICP-M30-8P8-0,3-RSC12T to a fieldbus device or to a controller with the corresponding PNP inputs as per the pin layout. To connect to a BL67 fieldbus station (e.g. BL67-16DI-P) use the RKC12T-2-CS19.121/TXL connection cable.

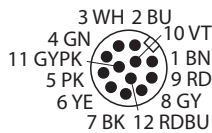

Fig. 20: Pin layout, primary side

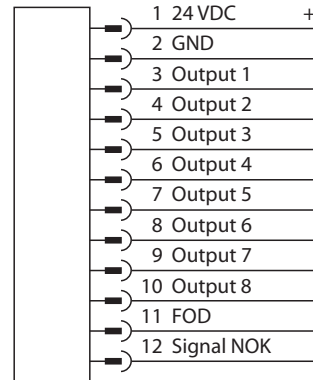

Fig. 21: Wiring diagram, primary side



NOTE

When transferring 8 standard PNP signals, pin 2 cannot be used as a digital input.

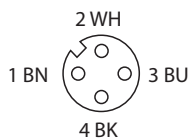

Fig. 22: Pin layout, secondary side

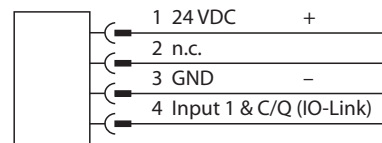

Fig. 23: Wiring diagram, secondary side

7 Commissioning

The device is ready for power transfer after the power supply is connected and switched on and after a power up delay of 160 ms. The delay for the data transmission is typically 750 ms, but can take longer in individual cases. The length of the delay, for example, may depend on the following factors:

- Connected devices on the secondary side
- Set cycle time in the IO-Link master

7.1 IO-Link mode

- ▶ Set the cycle time on the IO-Link master (min. 10 ms).
- ⇒ The IO-Link device is operated at double the cycle time.
- ⇒ The inductive coupler is operational.

8 Operation

On the primary side several components of the secondary side with the same configuration can also be operated (so-called Dynamic Pairing). With the power supply on the primary side a start-up delay of 10 ms must be expected.

8.1 LEDs

LED indication	Meaning
Lit	Data and power supply transfer error-free
Flashing (10 Hz)	Secondary side missing, no communication between primary and secondary side
Flashing (1 Hz)	FOD function active

8.2 Foreign object detection (FOD)

The device is provided with an FOD function (Foreign Object Detection). The FOD detects metal foreign objects in the active area between the primary and secondary side. The device then automatically switches off the power supply. The FOD status is indicated as follows:

Device	FOD active
NICP-M30-IOL2P8X-H1141	LED flashes at a frequency of 1 Hz.
NICP-M30-8P8X-0,3-RSC12T	FOD status pin is set.

As soon as the device no longer detects any metal, the system returns automatically to the operational state.

9 Troubleshooting

If the device does not function as expected, first check whether ambient interference is present. If there is no ambient interference present, check the connections of the device for faults. If there are no faults, there is a device malfunction. In this case, decommission the device and replace it with a new device of the same type.

10 Maintenance

Ensure that the plug connections and cables are always in good condition.

The devices are maintenance-free, clean dry if required.

The active area between the primary side and the secondary side must be cleared occasionally of any metal contamination (e.g. chips) in order to improve operation.

11 Repair

The device must not be repaired by the user. The device must be decommissioned if it is faulty.

Observe our return acceptance conditions when returning the device to Turck.

11.1 Returning Devices

Returns can only be accepted if a declaration of decontamination is enclosed with the device.

The declaration can be downloaded from

<https://www.turck.de/en/retoure-service-6079.php>

and must be completely filled in, and affixed securely and weather-proof to the outside of the packaging.

12 Decommissioning

- ▶ Remove the connection cable from the power supply and/or processing units.
- ▶ Disconnect the connection cable from the primary side.
- ▶ Disconnect the connection cable from the secondary side.
- ▶ Undo the connections of the device or if necessary the mounting aid for the mounting area.
- ▶ Undo if necessary the connection of the device to the mounting aid.

13 Disposal



The devices must be disposed of correctly and must not be included in normal household garbage.

14 Technical Data

14.1 Technical data of the primary side

Technical data	NICP-M30-IOL2P8X-H1141	NICP-M30-8P8-0,3-RSC12T
Operating voltage	24 VDC \pm 10 %	24 VDC \pm 10 %
Operating current	750 mA	750 mA
Nominal distance	0...7 mm	0...7 mm
Ambient temperature	-20...+55 °C	-20...+55 °C
Output function	4-wire PNP and IO-Link	12-wire PNP
Degree of protection	IP67 and IP68	IP67 and IP68
Electrical connection	M12 connector, 4-pin	Connection cable, 0.3 m, with M12 connector, 12-pin

IP68 means: IP67 + following tests:

- 24 hrs. continuous storage at -25 °C
- 24 hrs. continuous storage at +70 °C
- 7 day continuous storage in water at a depth of 1 m
- 10 temperature shock changes from -25 °C to +70 °C, time per temperature value: 1 hour

14.2 Technical data of the secondary side

Technical data	NICS-M30-IOL2P8-0,3-RKC4.4T
Output voltage	24 VDC \pm 10 %
Output function	4-wire PNP and IO-Link
Ambient temperature	-20...+55 °C
Degree of protection	IP67 and IP68
Output current	500 mA
Peak current output	2400 mA for 0.1 ms 10 A for 0.02 ms
Electrical connection	Connection cable, 0.3 m, with M12 connector, 4-pin
Min. input voltage for High level	8 V
Max. input voltage for Low level	5 V
Input current	<4.5 mA

IP68 means: IP67 + following tests:

- 24 hrs. continuous storage at -25 °C
- 24 hrs. continuous storage at +70 °C
- 7 day continuous storage in water at a depth of 1 m
- 10 temperature shock changes from -25 °C to +70 °C, time per temperature value: 1 hour

14.3 Technical data of inductive transfer system

Technical data	Inductive transfer system
Standby time	160 ms
Standby power, coupled	4 W
Standby power, not coupled	1 W
IO-Link communication	COM2/IO-Link 1.1.1, 38.4 kBaud
Rotation	1250 rpm
Short-circuit protection	Yes
Reverse polarity protection	Yes

14.4 Design

Technical data	
Housing material	Metal, CuZn, chrome-plated
Material of active face	Plastic, PA 12-GF30

15 Appendix: EU Declaration of Conformity

EU-Konformitätserklärung Nr. 5225-1M
EU Declaration of Conformity No.:



Wir/We

HANS TURCK GMBH & CO KG
Witzlebenstr. 7, 45472 Mülheim an der Ruhr, Germany

erklären in alleiniger Verantwortung, dass die Produkte
declare under our sole responsibility that the products

Primärseite: Primary side:	Type name	Ident-No.
	NICP-M30-8P8-0.3-RSC12T	4300201
	NICP-M30-IOL2P8X-H1141	4300101
Sekundärseite. Secondary side	Type name	Ident-No.
	NICS-M30-IOL2P8-0.3-RKC4.4T	4300301

die wesentlichen Anforderungen und andere relevante Anforderungen der folgenden EU-Richtlinien erfüllt
are in conformity with the essential requirements and other relevant requirements of the following EU-Directives:

Richtlinie / Directive RoHS 2011 / 65 / EU 08. Jun. 2011

Funk-Richtlinie / Radio Equipment Directive 2014 / 53 / EU 16. April 2016

und dass sie mit den folgenden harmonisierten Normen und / oder Regelungen übereinstimmen:
and are in conformity with the following harmonised standards and / or other regulations :

Gesundheit & Sicherheit (Art.3, (1) a): LVD 2014/35/EU: EN 62311:2008
Health & Safety (Art.3, (1) a) LVD 2014/35/EU: EN 62368-1:2014 + AC 2015

EMV (Art.3, (1) b) / EMV-RL 2014/30/EU: EN 61000-6-2:2005
 EMC (Art.3, (1) b) / EMC Directive 2014/30/EU: EN 61000-6-4:2007 + A1:2011
 Draft EN 301 489-1 V2.2.0
 Final Draft EN 301 489-3 V2.1.1

Spektrum (Art.3, (2)):
Spectrum (Art.3, (2)):
 EN 300 440 V2.1.1

Weitere (inkl. Art.3, (3) und freiwilliger Angaben): -
Other (incl. Art.3, (3) and voluntary specs):

Weitere Richtlinien, Normen: -
additional directives, standards:

Zusätzliche Informationen:
supplementary information:

Angewandtes RED-Konformitätsbewertungsverfahren gem. Art. 17, 2.(a):
ATEX - conformity assessment procedure according to Art. 17, 2.(a) applied:

Modul A INTERNE FERTIGUNGSKONTROLLE
module A INTERNAL PRODUCTION CONTROL

Bemerkungen: -
Remarks:

Mülheim, den 25.10.2018

i.V. U. Vix, CE-Koordinatorin / CE Coordinator

Ort und Datum der Ausstellung /
Place and date of issue

Name, Funktion und Unterschrift des Befugten /
Name, function and signature of authorized person

FM 7.3-27

07.09.17

TURCK

Over 30 subsidiaries and over
60 representations worldwide!

100003896 | 2018/11



www.turck.com